

# DUCTILE IRON PIPE SYSTEMS

Information of the European Association for Ductile Iron Pipe Systems · EADIPS®

# 52



# Topics and authors

4 Brief des Herausgebers / Letter from the editor

6 Schnellübersicht / Abstracts

## EADIPS FGR News

12 **Annual report for 2017 and outlook for 2018**

Manfred Künze

## Technical articles

16 **Resource efficiency through the use of ductile iron pipe systems**

Steffen Ertelt, Christoph Bennerscheidt and Jürgen Rammelsberg

22 **The production and use of hydrants in spheroidal graphite cast iron**

Jürgen Rammelsberg

28 **Modern epoxy powder coating for valves and fittings**

Volker Börschel

34 **Digitisation in the water supply industry**

Frank Endreß

38 **Interim pipelines in ductile cast iron are the best**

Uwe Hoffmann and Lutz Rau

## Historical

44 **The properties of ductile iron pipes**

Reinhard Schaffland

## Products and applications

52 **Loose-flanged butterfly valves for a perfect fit**

Matthias Müller

54 **The water supply for the Swiss district of Sarnen is a sustainable investment**

Werner Volkart

56 **Cast iron pipes withstand the onslaught of high water**

Roland Gruber

60 **Ductile iron pipes with restrained joints make difficult pipe-laying work possible in the Gastein Valley**

Roland Gruber

64 **The DÜKER plunger valve type 0816**

Ursula Ritter

66 **Replacement of the Gönhard reservoir in Aarau**

Roger Saner

70 **Water supply for Attisholz-Süd**

Roger Saner

**In brief**

27 **Renaturation of a stream in Villmergen with the help of cast iron pipes**

A pipeline linking two reservoirs

Magdeburg puts its trust in ductile cast iron with epoxy coating

33 **Ductile iron pipes installed with the burst lining technique**

Renovation of the sewage system in Ischgl

Fresh drinking water for two million Hamburg citizens

37 **Structural indicators of the German foundry industry**

30 years of snow-making equipment with cast iron pipe systems

43 **Resistance to root penetration**

Eco-power from wastewater

Relocation of a water supply pipeline in the Upper Palatinate

50 **Fürst-Pückler cast iron edition**

Optimum protection with ETEC enamel

New ERHARD TALIS logistics centre

TRM piling systems awarded the EPD

Frischhut invests in new production plant Revitalisation of the Friedrich power station in St. Michael

74 **EADIPS FGR Newsletter**

75 **Imprint**

76 **Members of EADIPS FGR**

Members location

# Brief des Herausgebers

Liebe Leserinnen und Leser,

die Digitalisierung hält nach und nach Einzug in alle Bereiche des menschlichen Lebens. Die klassischen Printmedien wurden durch digitale Medien ergänzt und in manchen Fällen sogar ersetzt. Auch die Medien der EADIPS FGR haben schon frühzeitig den Weg beschritten, Informationen über duktile Guss-Rohrsysteme digital verfügbar zu machen. Die Anpassung unseres Internetauftritts im Jahr 2016 war nur ein weiterer, aber konsequenter Schritt, Lesbarkeit und Auffindbarkeit zu verbessern. Die im Hintergrund laufenden Prozesse zur weiteren Optimierung unserer digitalen Medien sind für den Nutzer häufig unsichtbar.

Auch vor der Wasserwirtschaft wird die Digitalisierung nicht haltmachen. Nach dem Motto „Früher oder später kriegen wir sie!“ bestimmen digitalisierte Prozesse zunehmend das Handeln bei der Herstellung, dem Vertrieb, der Nutzung und der Wiederverwertung von duktilen Guss-Rohrsystemen. Es ist zu erwarten, dass dadurch die Effizienz gesteigert und neue Produkte entwickelt werden können.

Um diesen Weg mit den EADIPS FGR-Mitgliedern und den Betreibern von Netzen und Anlagen gemeinsam aktiv zu beschreiten, haben wir im Mai 2017 die Arbeitsgruppe „Digitalisierung“ ins Leben gerufen. Die EADIPS FGR setzt sich in der Arbeitsgruppe speziell für die Standardisierung der Rückverfolgbarkeit aller Komponenten im Netz ein, auch der erdüberdeckten.

Hintergründe zur Digitalisierung sind im Beitrag „Digitalisierung in der Wasserversorgung“ von Frank Endreß (Sprecher der AG Digitalisierung) dargestellt.

Eng mit diesen Prozessen verknüpft ist der schonende Umgang mit den uns zur Verfügung stehenden Ressourcen. Messtechnik erleichtert das Auffinden von Undichtigkeiten in den Netzen.

Der Einsatz von Online-Sensorik und die punktgenaue Visualisierung der Messpunkte und der Undichtigkeiten über Web-Oberflächen machen den Nutzen für den Netzbetreiber direkt sichtbar und können dazu dienen, die Ressource Frischwasser zu schonen.

Von den Nutzern unbemerkt werden duktile Guss-Rohrsysteme ressourcenschonend mit Schrott als Recyclingmaterial hergestellt. Rohre, Formstücke und Armaturen sind somit das einzige Rohrsystem, aus dem nach Ablauf der Lebensdauer erneut ein Rohrsystem mit gleicher Qualität hergestellt werden kann; ganz nach dem Motto: „Ich war ein duktiler Gussrohr und möchte auch wieder ein duktiler Gussrohr werden“. Halten Sie sich beim Lesen der Beiträge vor Augen, dass die in den Anwendungen eingesetzten Produkte nach Ablauf der Lebensdauer nicht einer thermischen Verwertung zugeführt werden oder als Abfall enden, sondern erneut als Rohstoff für hochwertige Produkte genutzt werden.

Lassen Sie sich inspirieren.



Es grüßt Sie herzlich

A handwritten signature in blue ink, appearing to read 'C. Bennerscheidt', written in a cursive style.

Christoph Bennerscheidt

# Letter from the editor

Dear readers,

Digitisation is gradually finding its way into all aspects of human life. The traditional print media have been supplemented and in some cases even replaced by digital media. And at EADIPS FGR, too, we have not been slow in embarking upon the path of making information about ductile iron pipe systems available digitally. The adaptation of our website in 2016 was simply a further, but logical, step in improving readability and navigation. The processes running in the background for the further optimisation of our digital media are often invisible to users.

And digitisation will not stop short of the water management sector. Based on the idea that it will happen sooner or later, digitised processes are increasingly determining behaviour as regards the production, marketing, use and recycling of ductile iron pipe systems. It is to be expected that this will increase efficiency and mean that new products can be developed.

So that we can make a proactive start on this path together with EADIPS FGR members and network and equipment operators, in May 2017 we set up the "Digitisation" working group. Within this working group, EADIPS FGR is particularly promoting the standardisation of traceability for all components in the network, including those installed underground. The article entitled "Digitisation in the water supply industry" by Frank Endreß (the spokesman of the Digitisation working group) provides some background information on digitisation.

Closely linked with these processes is the considerate handling of the resources available to us. Measurement technology makes it easier to locate leaks in networks.

The use of online sensor technology and pinpoint accuracy in the visualisation of measuring points and leaks via web interfaces, mean that network operators can monitor usage directly and helps to conserve our resources of fresh water.

Something which often goes unnoticed by users is the fact that ductile iron pipe systems are produced from recycled scrap material, thereby saving resources. This means that pipes, valves and fittings represent the only pipe system which, after the end of its working life, can be used to produce a new pipe system of equal quality; true to the motto: "I used to be a ductile iron pipe and I would like to become a ductile iron pipe again". When you are reading these articles, remember that, at the end of their working life, the products used in the applications described are not sent off for thermal recovery and do not end up as waste – they are used again as the raw material for high-quality products.

Let yourself be inspired.

Warmest greetings



Christoph Bennerscheidt

# Schnellübersicht / Abstracts

## Jahresbericht 2017 und Ausblick 2018

Manfred Künze

Erstmals veröffentlicht der Vorstand der EADIPS FGR einen Jahresbericht mit Ausblick auf das kommende Geschäftsjahr 2018 im Jahresheft. Er legt die Struktur des Verbandes mit ordentlichen und Fördermitgliedern dar und markiert neben der Öffentlichkeits- und Regelwerksarbeit die wichtigsten Handlungsfelder für eigene Projekte und Entwicklungsziele:

- die Digitalisierung der Wasserwirtschaft,
- Anpassungsmaßnahmen an den Klimawandel (Boden-Rohr-System) sowie
- ein noch effizienterer Umgang mit Ressourcen.

Diese Handlungsfelder sind untereinander vernetzt und müssen sowohl auf technischer als auch politischer Ebene weiterentwickelt werden.

## Ressourceneffizienz durch Einsatz duktiler Guss-Rohrsysteme

Steffen Ertelt, Christoph Bennerscheidt und Jürgen Rammelsberg

Die Bedeutung des Klimawandels für das Leben auf der Erde ist weitestgehend unbestritten. Die weltweiten Aktivitäten für eine Verlangsamung des Temperaturanstiegs betreffen eine Verringerung der globalen Schadstoffemissionen und eine Verminderung der Entnahme fossiler Rohstoffe aus der Erdkruste. Damit ist wiederum ein geändertes Konsum- und Nutzungsverhalten in Richtung längerer Nutzungsdauern und eine Stärkung der Kreislaufwirtschaft verbunden. Am Beispiel der Erzeugung und Nutzung duktiler Guss-Rohrsysteme wird die effiziente Schonung natürlicher Ressourcen beschrieben.

## Herstellung und Einsatz von Hydranten aus Gusseisen mit Kugelgraphit

Jürgen Rammelsberg

Die EADIPS FGR stellt mit ihrem E-Book „Guss-Rohrsysteme – Rohre, Formstücke und Armaturen aus duktilem Gusseisen“ Planern, Anwendern und Ausbildern ein umfangreiches und ständig aktualisiertes Kompendium über duktile Guss-Rohrsysteme zur Verfügung. Das Kapitel über Armaturen ist wegen deren Vielfalt an Konstruktionen und Aufgaben derart umfangreich, dass es sich anbot, die Gruppe der Hydranten in einem eigenen, leicht gekürzten Beitrag im Jahresheft darzustellen.

## Annual report for 2017 and outlook for 2018

Manfred Künze

For the first time, the board of EADIPS FGR is publishing an annual report with an outlook for the coming business year of 2018 in the Annual Journal. It outlines the structure of the Association with full members and sponsoring members and, in addition to public relations and standardisation work, it highlights the most important areas of activity for its own projects and development targets:

- digitisation in the water supply industry,
- measures for adapting to climate change (soil-pipe system) and
- even more efficient handling of resources.

These areas of activity are all interlinked and need to be developed further on both technical and political levels.

## Resource efficiency through the use of ductile iron pipe systems

Steffen Ertelt, Christoph Bennerscheidt und Jürgen Rammelsberg

The significance of climate change for life on earth is largely undisputed. Activities on a worldwide basis to slow down the rise in temperature involve decreasing global pollutant emissions and reducing the extraction of fossil resources from the earth's crust. In turn, this is associated with an altered behaviour as regards consumption and use, tending more towards a longer working life and a strengthening of the recycling economy. With reference to the production and use of ductile iron pipe systems, this article describes the efficient conservation of natural resources.

## The production and use of hydrants in spheroidal graphite cast iron

Jürgen Rammelsberg

With its e-book "Cast iron pipe systems – pipes, fittings and valves in ductile cast iron", EADIPS FGR offers planners, users and instructors an extensive and constantly updated compendium of ductile iron pipe systems. The chapter on valves is so extensive – because of the multitude of constructions and tasks – that it was a good idea to present the group of hydrants in its own, slightly abridged version in the Annual Journal.

## Moderne Epoxidharz-Pulverbeschichtung für Armaturen und Formstücke

Volker Börschel

Bei Armaturen und Formstücken aus duktilem Guss-eisen steht der Korrosionsschutz an vorderster Stelle: Er ist Grundvoraussetzung für einen hygienisch einwandfreien Trinkwassertransport, er sorgt für die Möglichkeit des Einbaus in allen Böden, er bewahrt den Werkstoff vor chemischen Angriffen aller Art. Auch hier ist die jüngere Vergangenheit geprägt von grundlegenden Entwicklungen. Den bedeutendsten Rang nimmt die Beschichtung mit Epoxidharz-Pulverlacken ein. Der Beitrag widmet sich einerseits der Herstellung des Beschichtungspulvers aus Grundstoffen mit komplizierten Zulassungsprozeduren, andererseits nimmt er die penible Vorbehandlung der Werkstücke und den gesamten Beschichtungsprozess unter die Lupe. Hier liegt die Basis für eine qualitativ hochwertige Beschichtung.

## Digitalisierung in der Wasserversorgung

Frank Endreß

In allen Bereichen des Lebens, der Wirtschaft und der Gesellschaft vollzieht sich derzeit der Trend zu einer umfassenden Digitalisierung, so auch im Bereich der Wasserwirtschaft. Es begann vor einigen Jahren beim Übergang von der manuellen zur digitalen Auslesung von Zählerständen, setzte sich fort in fern-auslesbaren Zählern, fern-messbaren Wasserzuständen im gesamten Leitungsnetz, fern-messbaren und digital in Leitungsdokumentationen eingefügten Korrelationsmessungen zur Feststellung von Leckagen. Ein weiterer Trend beschäftigt sich mit der Rückverfolgbarkeit aller Komponenten, die in einem Leitungsnetz eingebaut sind. Langfristiges Ziel ist die Vernetzung von autonomen Strukturen, Abläufen und Prozessen.

## Modern epoxy powder coating for valves and fittings

Volker Börschel

Corrosion protection is one of the top priorities for valves and fittings in ductile cast iron: it is a basic requirement for the hygienic and problem-free transport of drinking water, it makes installation possible in all types of soil and it preserves the material against chemical attacks of all kinds. Here again, some fundamental developments have made their mark in the recent past. Of greatest importance here are Fusion Bonded Epoxy coatings. This article first looks at the production of the coating powder from raw materials and the complicated approval procedures involved and then examines the meticulous pre-treatment of components and the entire coating process. This forms the basis for high-quality coating.

## Digitisation in the water supply industry

Frank Endreß

In all areas of life, the economy and society, there is currently a trend towards comprehensive digitisation; this is also the case with the water supply industry. It began a few years ago with the changeover from manual to digital reading of meters and progressed to remotely readable meters, the remote measurement of the water status throughout the network of pipelines and the remote measurement and digital inclusion of correlation measurements in the pipeline documentation in order to detect leaks. A further trend concerns the traceability of all components installed in a pipeline network. The long-term aim is the cross-linking of autonomous structures, sequences and processes.

## Interimsleitungen aus duktilem Gusseisen sind optimal

Uwe Hoffmann und Lutz Rau

In der Wasserwirtschaft müssen häufig Leitungsbereiche inspiziert, repariert oder saniert werden, ohne dass der Leitungsbetrieb langfristig unterbrochen werden kann. Abhilfe schafft der Bau einer sogenannten Interimsleitung, die vorübergehend den Betrieb übernimmt, bis der ursprüngliche Leitungsabschnitt seine Aufgabe wieder wahrnehmen kann. Wenn es die Platzverhältnisse erlauben, liegen die Rohre der Interimsleitungen frei auf dem Boden und müssen gegen die im Betrieb auftretenden Kräfte gesichert werden. Duktile Guss-Rohrsysteme haben sich besonders gut bewährt, weil sie robust sind und nach der Demontage am nächsten Bauabschnitt leicht wiederverwendet werden können. Sie verfügen über mehrere Systeme längskraftschlüssiger Verbindungen, die auch leicht und einfach wieder zu demonstrieren sind. Nach einem Rückblick auf früher ausgeführte Projekte wird im Beitrag eine Interimsleitung beschrieben, die während der Sanierung einer Abwasserdruckleitung in Berlin erforderlich wurde. Hier zeigte sich beispielhaft die Robustheit der Rohre: Selbst eine vom Sturm auf die Leitung geworfene alte Eiche konnte keinerlei erkennbare Beschädigung hervorrufen.

## Eigenschaften duktiler Gussrohre

Reinhard Schaffland

Es sind jetzt 50 Jahre vergangen, seit Reinhard Schaffland den ersten Beitrag zur Geschichte und Einordnung des damals noch jungen Werkstoffes „duktiler Gusseisen“ schrieb. Damals suchte man noch nach werkstoffgerechten Prüfverfahren, weil die bekannten, beim Grauguss bewährten Methoden das plastische verformbare Verhalten des neuen Werkstoffes nicht adäquat abbildeten. Dabei ist es erstaunlich, wie mutig man damals technisches Neuland betrat: Das erste größere Projekt war bereits 10 Jahre vorher eine 100 km lange Gashochdruckleitung!

## Interim pipelines in ductile cast iron are the best

Uwe Hoffmann and Lutz Rau

In the water supply industry, it is often necessary for sections of network to be able to be inspected, repaired or renovated without interrupting supplies for any length of time. A remedy for this is the construction of a so-called interim pipeline, which temporarily takes over supply until the original section of pipeline can be put back into operation. If space permits, the pipes of the interim pipelines are laid in the open on the ground and so need to be protected against the forces acting on them. Ductile iron pipe systems have proved to be particularly good for this purpose because they are robust and can easily be dismantled and reused on the next section to be worked on. There are various systems of restrained joints available for them, which are also easily and simply dismantled again. After a review of some previous projects, the article describes an interim pipeline which was needed during the renovation of a sewage pressure pipeline in Berlin. This was an exemplary illustration of the robustness of the pipes: even an old oak tree thrown onto the pipeline during a storm could not cause any discernible damage.

## Properties of ductile iron pipes

Reinhard Schaffland

It has been 50 years since Reinhard Schaffland wrote the first article on the history and classification of “ductile cast iron”, which was a recently developed material at the time. In those days people were still looking for appropriate processes for testing this material because the known and proven methods used for grey cast iron did not adequately describe the plastic ductility capabilities of the new material. The ground-breaking boldness with which this new technology was being pushed forward is quite astonishing: the first major project was a 100 km long high-pressure gas pipeline, 10 years before this!



## Absperrklappe mit Losflansch für eine perfekte Verbindung

Matthias Müller

Im Anlagenbau ist der Einsatz von Armaturen mit Flansch-Anschluss üblich; sie verfügen über genormte Baulängen und sollten daher relativ leicht zu Wartungs- oder Reparaturzwecken ausgewechselt werden können. Leider sind die Verhältnisse in der Praxis nicht ganz so einfach: Mit der verpressen Flanschdichtung kann die alte Armatur nur mit Gewalt oder speziellen Werkzeugen ausgebaut werden. Der Einbau einer baugleichen Armatur mit identischer Baulänge und üblichen Flanschdichtungen wird wegen des fehlenden Axialspiels nahezu unmöglich. Beim Einbau einer neuen Armatur in eine bereits montierte Leitung wird das Spiel zwischen den bestehenden Flanschen mit Pass- und Ausbaustücken ausgeglichen. Die Armatur mit Losflansch überwindet die geschilderten Probleme elegant.

## Die Wasserversorgung der Schweizer Gemeinde Sarnen investiert nachhaltig

Werner Volkart

Im Schweizer Kanton Obwalden wird die Struktur der Wasserversorgung mehrerer Gemeinden verbessert. Damit ist der Bau neuer Versorgungsleitungen und Reservoirs verbunden. Gleichzeitig wird die beträchtliche Höhendifferenz im Leitungsnetz durch eine neue Trinkwasserturbine zur Erzeugung von Elektrizität genutzt, ebenfalls ein Beispiel von gelebter Ressourceneffizienz mit Hilfe duktiler Gussrohre, welche mit ihrem robusten Außenschutz die Wiederverwendung des steinigen Bodenaushubs erlauben und den Transport von Bettungsmaterial erübrigen.

## Loose-flanged butterfly valves for a perfect fit

Matthias Müller

In general plant construction, the use of valves with flange connections is customary; they come in standardised lengths and should therefore be relatively easy to exchange for maintenance or repair purposes. Unfortunately, however, things are not quite so simple in practice: the compaction of the flange seal means that the old fitting can only be removed with force or by using special tools. And the installation of an identical valve of exactly the same length and the usual flange seals becomes almost impossible because of the lack of axial play. When installing a new valve into a pipeline which is already laid, the clearance between the existing flanges is made up with dismantling joints. The loose-flanged butterfly valve is an elegant way of overcoming the problems described.

## The water supply for the Swiss district of Sarnen is a sustainable investment

Werner Volkart

In the Swiss canton of Obwalden, the structure of the water supply system to a number of communities is being improved. This involves the construction of new supply pipelines and reservoirs. At the same time, the considerable height difference in the pipeline network is going to be used for producing electricity via a new drinking water turbine: another example of resource efficiency in practice with the help of ductile iron pipes which, with their robust external protection, allow the stony excavation soil to be reused and avoid the need for transporting bedding material.

## Gussrohre halten Belastungen durch Hochwasser stand

Roland Gruber

Im alpinen Gelände mit seinen Steilhängen und großen Höhendifferenzen schlummern große Reserven für die Erzeugung erneuerbarer Energie mit Kleinwasserkraftwerken. Die Turbinenleitungen sind oft höchsten Beanspruchungen durch die äußeren Bedingungen des Geländes und der Witterung ausgesetzt. Dabei setzen besonders Starkregenereignisse mit Überflutungen den Leitungen zu, sie werden oftmals freigespült und verlieren die zusammenhaltende Bettung. Stromausfall und teure Reparaturen sind die Folge. Der Beitrag untersucht die Schadenshäufigkeit von schubgesicherten und nicht schubgesicherten Leitungen. Eindeutiges Ergebnis: Die Leitungen mit längskraftschlüssigen Verbindungen überstehen die Unwetter ohne größere Schäden. Die Versicherungswirtschaft bereitet Vertragsbedingungen vor, wonach die Prämien für zugesicherte Leitungen geringer ausfallen werden.

## Duktile Gussrohre in zugfester Ausführung ermöglichen schwierigen Leitungsbau im Gasteinertal

Roland Gruber

Der Bau einer Turbinenleitung DN 500 im unwegsamen und steilen Gelände ist allein technisch schon eine Herausforderung, der nur wenige Baufirmen gewachsen sind. Vonseiten der Genehmigungsbehörden kommen dann noch umweltschutzbedingte Auflagen und Zeitfenster zum Tragen, die das Bauen zusätzlich erschweren. Im Beitrag wird das „volle Programm“ beschrieben, das von der Baumannschaft zu leisten ist: Steilhänge, unwegsames Gelände, Querung eines Wildbachs, extrem schmale Baufelder, Schutz vor Steinschlag und einiges mehr. Mit duktilen Gussrohren mit zugfester Verbindung ist dieser Mix aus Problemen am wirtschaftlichsten zu bewältigen. Am Ende wird das Kraftwerk Luggauerbach im Regeljahr rund 4 GWh an sauberen Strom erzeugen. Damit können etwa 1.000 durchschnittliche Gasteiner Haushalte versorgt und jährlich rund 3.400 Tonnen CO<sub>2</sub>-Emissionen eingespart werden.

## Cast iron pipes withstand the burden of high water

Roland Gruber

Alpine country, with its steep slopes and enormous height differences, holds great potential reserves for the production of renewable energy with small hydropower plants. The penstocks are often exposed to extreme stresses from the external conditions of the terrain and from the weather. Particularly severe rain conditions can inundate the pipelines and the bedding on which they are based can often be washed away. Power failures and costly repairs are the consequence. This article examines the frequency of damage with restrained and non-restrained pipelines. The clear result is that pipelines with restrained joints survive severe weather without major damage. The insurance industry provides contractual conditions in which the premiums for restrained pipelines are lower.

## Ductile iron pipes with restrained joints make difficult pipe-laying work possible in the Gastein Valley

Roland Gruber

For technical reasons alone, the construction of a DN 500 penstock in this rough and steep terrain is a challenge which only a few construction companies are capable of meeting. But, also to be considered here were environmental requirements set by the approval authorities and a time window which made construction work even more difficult. This article describes the complete agenda of tasks to be fulfilled by the construction team: steep slopes, rough terrain, the crossing of a mountain stream, extremely tight working space, protection against rockfalls and so on. Using ductile iron pipes with restrained joints this whole set of problems can be handled in the most economical way. In the end, the Luggauerbach power plant will be producing around 4 GWh of clean energy in a normal year. This will enable about 1,000 average households in Gastein to be supplied and around 3,400 tonnes of CO<sub>2</sub> emissions to be saved each year.

## Das DÜKER Ringkolbenventil Typ 0816

Ursula Ritter

Der Beitrag widmet sich dem komplizierten Innenleben einer wichtigen Regelarmatur, dem Ringkolbenventil. Das Ringkolbenventil übernimmt als „Alleskönner“ Schlüsselfunktionen in Anlagen und Transportleitungen: Es arbeitet als Absperr-, Regel-, Rückschlag-, Sicherheits- und Messarmatur. Bei der Optimierung dieser bewährten Konstruktion wurden jahrelange Praxiserfahrungen berücksichtigt. Diese betreffen einerseits die Werkstoffe, welche eine störungsfreie lange Nutzungsdauer ermöglichen. Strömungssimulationen zeigen den Weg zur weiteren Verbesserung des Strömungskoeffizienten. Konstruktionsdetails und Beschichtungswerkstoffe sind Garant für höchste Maßstäbe in der Trinkwasserhygiene. Wieder einmal zeigt sich, dass nichts so gut ist, dass es nicht verbessert werden kann.

## Ersatz-Reservoir Gönhard in Aarau

Roger Saner

Die geänderten Bedingungen der Trinkwasserversorgung in Aarau, Schweiz, machte eine Änderung ihrer Struktur erforderlich. Kernstück dieses Projektes war der Neubau eines zentralen Trinkwasserreservoirs und der Entfall der drei bestehenden und zu kleinen Behälter. Dies hatte umfangreiche Änderungen am bestehenden Leitungsnetz zur Folge. Der Bau einer neuen Transportleitung DN 400 aus duktilen Gussrohren mit integraler Umhüllung und Auskleidung aus Polyurethan steht im Mittelpunkt des Beitrags.

## Wasserversorgung Attisholz-Süd

Roger Saner

Ein brachliegendes Industriegebiet mit 22 ha Fläche in der Nähe von Solothurn, Schweiz, wird für neue Ansiedlungen der Pharmaindustrie neu erschlossen. Neben dem Bau der Straßen ist auch die gesamte Leitungsinfrastruktur zu errichten, wobei gleichzeitig auch der Bau der Produktions- und Verwaltungsgebäude läuft. Wegen des erhöhten Wasserbedarfs der bio-pharmazeutischen Produktion ist gleichzeitig die gesamte Wasserbeschaffung aus der weiteren Umgebung neu zu strukturieren. Der Einbau der etwa 2,5 km langen Leitungen für die Trink- und Löschwasserversorgung im Bereich DN 125 bis DN 400 mit Rohren, Formstücken und Armaturen aus duktilem Gusseisen mit moderner Korrosionsschutztechnik (Polyurethan) wird im Beitrag eingehend beschrieben.

## The DÜKER plunger valve type 0816

Ursula Ritter

This article looks into the complex inner workings of an essential control valve – the plunger valve. As an all-rounder, the plunger valve fulfils key functions in equipment and transport pipelines: it acts as a shutoff valve, a regulating valve, a check valve, a safety valve and a measurement device. The optimisation of this proven construction is based on many years of practical experience. Among other things, this relates to materials which allow a long and problem-free working life. Flow simulations point the way to the further improvement of flow coefficients. Construction details and coating materials guarantee the highest standards in drinking water hygiene. Once again, we can see that nothing is ever so good that it cannot be improved.

## Reservoir replacement at Gönhard in Aarau

Roger Saner

Changes in the conditions of the drinking water supply in Aarau, Switzerland, meant that its structure needed to be altered. The key element in this project was the construction of a new central drinking water reservoir and the decommissioning of three existing tanks which were too small. This resulted in some extensive changes to the existing pipeline network. This article focuses on the construction of a new DN 400 transport pipeline in ductile iron pipes with integral polyurethane coating and lining.

## Water supply for Attisholz-Süd

Roger Saner

A disused industrial zone with an area of 22 ha in the vicinity of Solothurn, Switzerland, is being developed for new establishments for the pharmaceutical industry. In addition to the building of roads, the entire infrastructure of pipelines is also to be laid – while the construction of the production and administration buildings is in progress. Because of the increased water requirement involved in bio-pharmaceutical production, the entire water procurement system from the wider surroundings is to be restructured at the same time. The installation of the approximately 2.5 km long pipelines for the supply of drinking and extinguishing water in the DN 125 to DN 400 range with pipes, fittings and valves in ductile cast iron with modern corrosion protection technology (polyurethane) is described in detail in this article.

Manfred Künze

## Annual report for 2017 and outlook for 2018

For 50 years now, EADIPS FGR, the European Association for Ductile Iron Pipe Systems / Fachgemeinschaft Guss- Rohrsysteme e. V. has been supporting planners, users and operators of water supply and wastewater systems in their choice of European-produced pipes, fittings and valves. But it is a long time since the use of these robust and technically mature system components has ceased to be restricted to the water supply and sewage sector alone. Pipelines and equipment in small hydropower plants, snow-making equipment etc. have been constructed from "ductile cast iron" material for decades now. This means that planners, users and operators can have recourse to the experience and technical knowhow of the full members of EADIPS FGR.

The full members of EADIPS FGR are:

- Düker GmbH
- Duktus (Wetzlar) GmbH & Co. KG
- Erhard GmbH & Co. KG
- Ludwig Frischhut GmbH & Co. KG
- Keulahütte GmbH
- TRM – Tiroler Rohre GmbH
- vonRoll (hydro) suisse ag
- vonRoll (hydro) deutschland gmbh

In addition there are also sponsoring members, who support the work of EADIPS FGR:

- Akzo Nobel Powder Coatings GmbH
- Friedrichshütte GmbH
- Rhein-Ruhr Collin KG Geschäftsbereich HTI
- TMH Hagenbucher AG
- Tröger + Entenmann KG

- Saint-Gobain Building Distribution Deutschland GmbH
- SATTEC DBS GOMMA SRL
- Vertriebsgesellschaft für Tiefbau und Umwelttechnik mbH + Co. KG
- Woco IPS GmbH – Business Unit Pipe System Components

According to its articles of association, the tasks which EADIPS FGR sets itself include public relations and the associated communication with planners and operators as well as work with manufacturers and operators to revise and/or supplement the rules and regulations of the industry or to draw up new ones on the basis of the latest available knowledge. But all this work on public relations and rules and regulations is not an end in itself. It can and must be used to identify tasks with a current practical relevance, to reclassify products and to pick up on developments, in order to work out economic solutions for operators.

### Public relations work

The public relations work of EADIPS FGR involves highlighting the advantages of ductile iron pipe systems, in which it addresses different target groups and the different tools available to them. The central medium is the Association's Website, which underwent some very striking changes in 2016: it is more modern, its appearance is fresher and it takes account of changes in the way that its users work. In addition, the Association has meanwhile started to use social media such as Facebook, LinkedIn and XING, in order to arouse the interest of the younger generation with short text and image contri-

butions. Work on the E-Book, the "bible for ductile iron pipe systems" has continued and the comprehensive chapter on Valves has been completed. Preparations have been finalised for the next conference for university lecturers on 18 and 19 February 2018 with talks, a factory tour and the inspection of a 43-year-old wastewater culvert under the River Mosel. Numerous presentations demonstrate the widest range of applications of ductile iron pipe systems to diverse audiences.

### Rules and regulations

Standards and regulations at national, European and international level are the basis for the functional reliability and long working life of pipe systems.

EADIPS FGR and colleagues from its member companies compile and revise rules and regulations on a permanent basis in various national and international standardisation committees.

At national level, this basically happens in working and advisory committees of the DIN standardisation institute. Such work at DIN level was carried out in the following DIN working (AA) and advisory (BR) committees:

In the standardisation committee for water management (NAW), abbreviated to NA 119, these are NA 119 BR, which advises the standards committee for water management, and NA 119-05-32 AA on cast iron pipes for sewage systems and pipelines as a mirror committee for wastewater standards, which are compiled on a European and international level.



Members of the technical committee of EADIPS FGR during the meeting at Keulahütte GmbH in Krauschwitz in February 2017

This includes both gravity systems and pipelines and pressure pipe systems. Added to this there was collaboration in the DIN-DVGW joint committee NA 119-07-17 AA for metal pipes and pipe joints for piping systems outside buildings, which is responsible for the standardisation of all aspects of drinking water supply.

In 2017, among other things, the calculation basis for working out the lengths to be secured when using pipe bends described in DVGW-GW 368 [1] – Restrained socket joints for ductile iron and steel pipes, fittings and valves was re-verified by this committee.

At European level, standards for cast iron pipes are compiled in technical committee TC 203 at CEN, the European Standardisation Committee. In Working Group 9, WG 9 – Revision of EN 545, EN 598 and EN 969 of the TC 203, after some intensive work in 2017, the draft version of harmonised standard prEN 598 [2] was able to be completed on the basis of mandate M/131 [3]. An important modification in the draft was the inclusion of the Reaction to Fire as an

“essential characteristic” in the harmonised product standard in accordance with [3].

In addition, on a proposal by EADIPS FGR and with the support of all members of WG 9, for the first time a method determining the root resistance of push-in joints was included in a harmonised standard for ductile cast iron pipes, fittings and accessories (see Annex C in [2]). The content of this was prepared in part at meetings of the EADIPS FGR technical committee. The method determining root resistance is also described in EADIPS FGR standard 76 [4] published in February 2017.

In WG 8 – Coatings for pipes, fittings and accessories – of TC 203 the latest modifications were able to be included in EN 15655 “Ductile iron pipes, fittings and accessories – Internal polyurethane lining for pipes and fittings – Requirements and test methods” and the draft was sent off to CEN for a second checking.

The national mirror committee for this is the working committee for NA 082-00-05 AA. Furthermore it was possible for substantial sections of a second part of EN 14901 “Ductile iron pipes, fittings and accessories – Thermoplastic acid modified polyolefin linings and coatings (TMPO) of pipe systems – Requirements and test methods” to be produced. In advance of this, the decision was made to split EN 14901 into two parts.

As is usual, the requirements and test methods for epoxy linings and coatings are now standardised in Part 1 and the requirements and test methods for linings and coatings in thermoplastic acid modified polyolefins are included in the new Part 2. In this way, once the standard has been completed, it will be possible for the user to compare the properties of the two products with ease.

Since the beginning of 2017, EADIPS FGR has been a member of EDW – European Drinking Water, an initiative of FIGAWA (national association of companies in the gas and water supply industry).

EDW aims to support the EU Commission in introducing bases for testing and evaluating materials and products in contact with drinking water which are standardised across Europe and accepted by all countries. Alongside EADIPS FGR, a further 29 organisations and associations are members of EDW.

### RAL quality mark

The work carried out by EADIPS FGR on rules and regulations make it clear that quality and durability are essential properties of ductile iron pipe systems.

The quality of pipes, fittings and valves is described and monitored on the basis of the rules and regulations. For consumers or tendering agencies, because of the increasing number of products and a growing array of standards, it becomes more and more difficult to find products which meet the desired characteristics. This is particularly relevant for piping systems.

Reliable and neutral quality labels, such as the RAL quality mark, based on practical experience, provide a useful guide at this stage. Products are evaluated according to defined principles, the quality of the products is monitored and also action is taken against any infringements in the use of the quality mark. Therefore, at the last members meeting, the board and management of EADIPS FGR were given the task of contacting RAL – the German Institute for Quality Assurance and Labelling. The question to be looked into is the extent to which, in order to broaden and deepen the quality certification already in existence, EADIPS FGR can be assigned an RAL quality mark for ductile iron pipe systems.

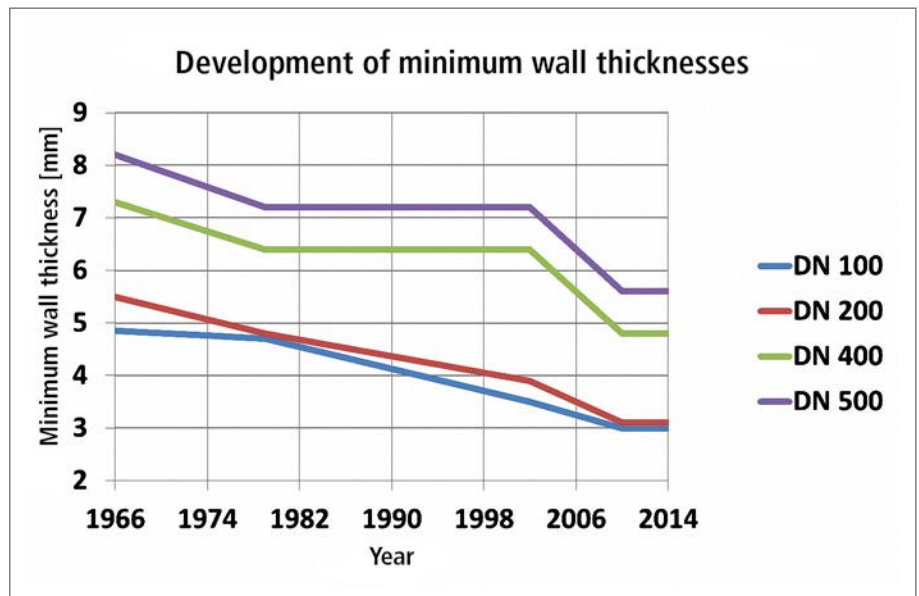

Development of minimum pipe wall thicknesses  $e_{min}$  from 1966 to 2014

### Digitisation

Digitisation is continuing to forge ahead in all areas and it is also going to result in changes in the water industry. In order to support and shape this process of change, a resolution has already been passed at the 84th ordinary meeting of EADIPS FGR members to set up a Digitisation working group. Its inaugural meeting was held on 30 May 2017. The working group consists of employees from both full members and sponsoring members. Academic support is provided by the Ruhr-West University in Mülheim an der Ruhr, as a member of the research network on “Smart Water – opportunities and risks of a digitised water industry”. The focus of this interdisciplinary project run by the Ruhr-West University lies in the opportunities and risks presented by digitisation and cross-linking in the water management industry.

### Soil-pipe system and the sponge city

When it comes to countering the inner-city consequences of climate change, such as overheating and flooding, the ground in our cities is becoming increasingly important. Storing rainwater in the soil and then making this stored rainfall available for vegetation represent two major areas for future water management and vegetation technology. Combining these two elements is only possible if solutions are found in the fiercely contested underground space of our inner cities which create as little conflict as possible. The members of EADIPS FGR offer solutions for this which have already been presented by various operators as the soil-pipe system or as the “sponge city principle”. The core element here is a ductile iron pipe system which, by choosing a corresponding backfill material for the pipe trench, allows the soil to store rainwater while simultaneously providing root space for trees for city greening. For this type of construction, a combination of the root resistance of push-in joints with coatings which make it possible to use coarse-grained materials with good compaction properties in the pipe trench is

an essential characteristic. This is met in full by ductile iron pipe systems.

## Resource efficiency

In the context of standardisation work, sustainability criteria have been on the agenda for years now and they are addressed under the rather complex term “life cycle assessments”. This covers e.g. the reuse of products after they have been dismantled, the recycling of the raw materials used or the volumes of fossil resources involved in production. The efficient handling of resources has for decades been in focus for EADIPS FGR members. For example, in the last 5 decades more accurate production of thinner pipe walls using the centrifugal casting process has meant that the standard minimum wall thicknesses have been almost halved.

Something else which should be stressed is that pipes, fittings and valves from EADIPS FGR members are almost 100 % produced from recycled material and hence, as early as 2012 when the waste management and product recycling law [5] came into effect, the basic requirements were already being met. Intensified activities by EADIPS FGR in this sector are thus gaining importance in work on rules and regulations and at political level.

## Outlook

The activities of EADIPS FGR have always been and will also continue to be oriented around subjects which are relevant to operators. In future, the digitalisation of the water management industry will lead to a stronger cross-linking of manufacturers, suppliers and operators. Measures for adapting to climate change, the reduction of greenhouse gases and more careful handling of resources concern manufacturers, suppliers and operators alike. Monitoring the quality of cast iron pipe systems will continue to play an important role.

Three essential areas of activity for EADIPS FGR emerge from these considerations:

- the digitisation of the water management industry
- measures for adapting to climate change (soil-pipe-system) and
- more efficient handling of resources

It should be emphasised that the areas of activity must be considered as being interconnected and further developments need to take place at both technical and political level. Hence, for example, digitisation can contribute to a better understanding of processes relevant to the water industry or improve efficiency in the handling of the resources. EADIPS FGR and its members will continue the dialogue with planners, users and operators and intensify it at political level.

## Bibliography

- [1] DVGW-GW 368  
Restrained socket joints for ductile iron and steel pipes, fittings and valves;  
February 2003
- [2] prEN 598  
Coated and lined ductile iron pipes, fittings and their joints for sewerage and drainage applications –  
Product characteristics and test and assessment methods;  
2017
- [3] Mandat M/131  
PIPES, TANKS and ANCILLARIES not in contact with water intended for humans. Mandate to CEN/CENELEC concerning the execution of standardisation work for harmonized Standards,  
29 January 1999
- [4] EADIPS FGR standard 76:  
Rohre aus duktilem Gusseisen Steckmuffen-Verbindungen duktiler Guss-Rohrsysteme – Beständigkeit gegen das Eindringen von Wurzeln – Anforderungen und Prüfverfahren  
2017-02  
Download at eadips.org
- [5] Law regarding promoting the recycling economy and ensuring environmentally friendly waste management (Kreislaufwirtschaftsgesetz – KrWG)  
01 June 2012

## Author

**Manfred Künze**  
Chairman of the Board of  
EADIPS FGR

Duktus (Wetzlar) GmbH & Co. KG  
Sophienstraße 52 – 54  
D-35576 Wetzlar  
Phone: +49(0)6441 492225  
E-mail:  
manfred.kuenze@duktus.com

Steffen Ertelt, Christoph Bennerscheidt and Jürgen Rammelsberg

# Resource efficiency through the use of ductile iron pipe systems

## Introduction

Over the last few decades there has been growing recognition of the fact that one of the greatest risks to the existence of life on earth comes from excessive global warming, which first and foremost can be ascribed to the increase in so-called greenhouse gases (CO<sub>2</sub>, methane, water vapour) in the atmosphere and the intensified absorption of solar radiation the associated with this. The Paris agreement signed in 2016 by 195 member states of UNFCCC (United Nations Framework Convention on Climate Change) is an expression of the generally accepted target of limiting the increase in global warming to 2°C by the year 2050. The Convention states that worldwide greenhouse gas neutrality must be achieved in the second half of this century. Also, among the aims of the Paris Convention is limited global warming to considerably less than 2°C or, in fact, preferably to below 1.5°C.

In a Climate Protection Plan 2050 adopted at the end of 2016, the Federal Government has demonstrated its determination to achieve the overall objective of reducing greenhouse gases by a minimum of 55 % as compared with 1990. At the same time, this overall objective will be broken down into individual sectors for the first time (energy, industry, traffic, agriculture, waste management) [1].

Various individual measures can be deduced from the targets for each sector, including

- cutting back on the consumption of fossil fuels
- simultaneous reduction in the extraction and use of fossil resources
- promotion of the recycling economy
  - striving to achieve a useful life for products which is as long and problem-free as possible while meeting high drinking water hygiene standards
  - introducing products back into the materials cycle after the end of their useful life
  - minimising the effects on the environment during use

## Resource-friendly production processes and materials cycles

Particular importance is attached to handling the resources available to use efficiently and in the most climate-neutral way possible.

Resource efficiency – the considerate and efficient handling of natural resources by reducing energy, material and water consumption – is increasingly moving into focus when it comes to economic, ecological and social processes.

The conservation of resources follows the vision of an economy embedded in natural materials cycles with minimal consumption of resources, where development is not at the cost of other regions or future generations.

Therefore, it can only emerge holistically from a life-cycle perspective: from raw material extraction through processing, product design, commercialisation and operation to reuse or disposal [2].

The recycling economy makes a considerable contribution to the conservation of natural resources. By substituting primary raw materials, the environmental pollution of their extraction is also reduced. Furthermore, recycling and recirculation means that the import dependency of the European economy can be diminished.

With the current amendment of the recycling and waste law, this development will push waste management further towards resource and environment friendly material flow management. An important element of the amendment is the implementation of the new five-stage hierarchy of waste in the European framework directive on waste [3]:

1. Prevention
2. Preparing for reuse
3. Recycling
4. Other recovery, such as energy recovery
5. Disposal

It prioritises the prevention of waste and the preparation of waste for reuse over recycling, other means of recovery and environmentally compatible disposal. Reuse includes processes which make it possible to use products and their component parts for the same purpose as that for which they were originally intended.



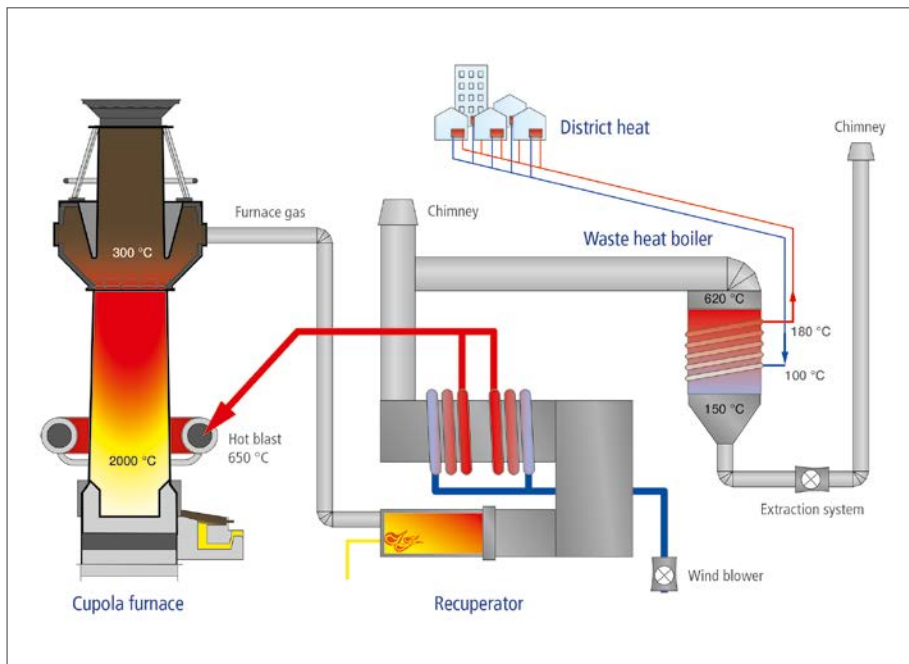

Cupola furnace with recuperator and downstream heat exchanger

The blast furnaces produced foundry pig iron from primary iron ore using large volumes of coke.

By contrast, in modern cupola furnaces or in electrical induction furnaces, steel scrap and cast iron scrap are reprocessed as secondary raw materials. The cast iron produced in this way does not suffer any loss in quality.

By means of this technological change alone, CO<sub>2</sub> emissions have been able to be reduced by around 65% [4]. A look at the way in which a cupola furnace works clearly shows additional potential for reducing CO<sub>2</sub> when we see how waste heat is used in the production process or can also be made available for other consumers.

An example of the further reduction of CO<sub>2</sub> emissions by optimising the processes of a cupola furnace is provided by the Duktus company in Wetzlar:

First of all, in 2016 the absolute coke use was reduced, and the specific coke use was improved. This resulted in a reduction in the output of CO<sub>2</sub> by 7.12% as compared with the previous year. In addition, by adaptations to the recuperator installed downstream of the cupola furnace, an optimisation of the furnace gas combustion was achieved. There is also the fact that the waste heat from the cupola furnace is then used as part of the generation of district heating for consumers in the city of Wetzlar. By these means in 2016 alone, the CO<sub>2</sub> emissions were reduced by 3,020 tonnes. In order to increase the efficiency of its process still further, additional district heating clients are currently being acquired.



Five-tonne medium frequency induction furnace  
(source: Ludwig Frischhut GmbH & Co. KG)

## Reducing consumption of fossil resources and fuels

The European manufacturers of cast iron pipe systems who have got together in EADIPS FGR have been early in starting to handle available resources more efficiently and, little by little, to adjust their manufacturing processes.

In many of the factories of EADIPS FGR members, in general no pig iron is used for the production of pipes, fittings and valves.

Right back in the 1980's a start was made on shutting down the blast furnaces, which were one of the greatest producers of CO and CO<sub>2</sub>, and introducing alternative production methods for cast iron:



Steel scrap (e.g. from the automobile industry)



Cast iron pipe scrap

As early as 2015, a cogeneration unit with a rated thermal output of 1.98 MW was put into operation, which since then has considerably reduced the CO<sub>2</sub>.

Another smelting unit which is often used in iron foundries is the induction furnace. A cylindrical crucible lined with refractory material is surrounded by a water-cooled induction coil. An alternating current passing through this coil induces a secondary voltage in the steel and cast iron scrap loaded into the crucible. The metal load acts as a short-circuited solenoid in which eddy currents are produced.

The eddy currents heat up the metal in the crucible from inside to a temperature far above its melting point. The alternating fields also bring about a homogenising circulation of the molten material. In particular, when this is considered in conjunction with the abandonment of fossil fuels for power generation in favour of the use of renewable energy from sun, wind and water, it can be expected that the CO<sub>2</sub> balance of induction furnaces will be improved even further.

meaning that natural resources are conserved and CO<sub>2</sub> emissions are sustainably reduced. The guiding principle is the efficient and environmentally compatible handling of natural resources, a more sustainable economy and the reuse of raw materials in the material cycle.

Ductile iron pipes and fittings can be almost 100% recycled. With the use of cast iron and steel scrap for producing ductile iron pipe systems, the foundries belonging to EADIPS FGR members are coming very close to the “cradle to cradle”, or C2C, concept.

### A closed-loop economy through the use of recycled materials

The basic material used for producing ductile cast iron consists of steel scrap and recycled material from the iron foundry. No fossil resources (iron ore) are used,

This concept was developed by Braungart and McDonough (see Braungart/McDonough 2005). It follows the fundamental idea that waste can be equated with food.



Cast iron scrap and recycled material

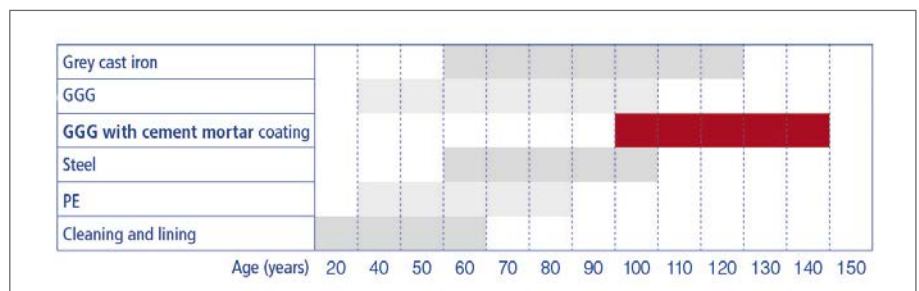

Technical working life according to process areas in the supply of drinking water (Source: [7])

Cradle-to-cradle thinking is going to replace the “cradle- to-grave” model in which material flows associated with the product are ultimately returned to nature as an unwanted output without ever being considered for further use while causing pollutants to accumulate in the environment. Instead of this, organic waste should be put back into a nutrient cycle and technical waste should be organised into technical cycles [5].

With C2C, at the end of their useful life products are returned to the production cycle in their entirety, without the new products which are produced from them suffering any reduction in quality. In contrast to this, with the cradle-to-grave principle products are dumped into the environment as waste at the end of their useful life without any further use being envisaged.

### The ecological and economic sustainability criteria of cast iron pipe systems

For a number of years now, EADIPS FGR members Duktus and vonRoll hydro have been successfully operating an environment management system according to the criteria of ISO 14001 [6]. Evidence of this is confirmed under the currently valid certificates TÜV 73 104 954 (Technische Überwachung Hessen GmbH) and SQS 20430 (Schweizer Vereinigung für Qualitäts- und Management-Systeme).

Ductile iron pipe systems offer secure, trouble-free network operation and are characterised by a long working life. Leaks in drinking water pipelines are responsible for the loss of valuable resources and defective sewers represent a potential hazard for groundwater. Ductile iron pipes with their special material properties provide outstanding protection. They are break-resistant

and the pipe wall is impermeable, meaning that the infiltration of pathogens and other impurities hazardous to health into the drinking water pipelines is practically excluded. With ductile iron sewage pipes, this impermeability prevents the exfiltration of environmentally hazardous substances into the surrounding area.

The most commonly used connections for ductile iron pipe systems is the TYTON® push-in joint. The continual development of pipe joints over the last 250 years has achieved a high degree of maturity with the TYTON® joint in the system of ductile iron pipes. This construction means that the joint is no longer the weakest link in

a pipeline. It is pressure tight up to the bursting pressure of the pipes themselves. Also it is easy and safe to assemble. Its performance range for use in gas, water and wastewater pipelines is established by standardised type tests across the whole range of nominal diameters. Positive experiences of its long-term behaviour stretch back over four decades of unaltered construction [7].



ORTOMAT MTC

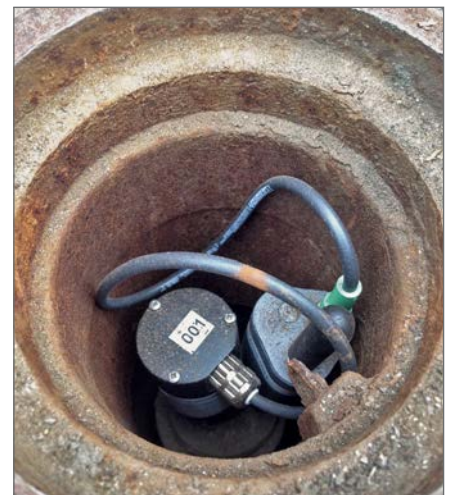

The ORTOMAT MTC in situ

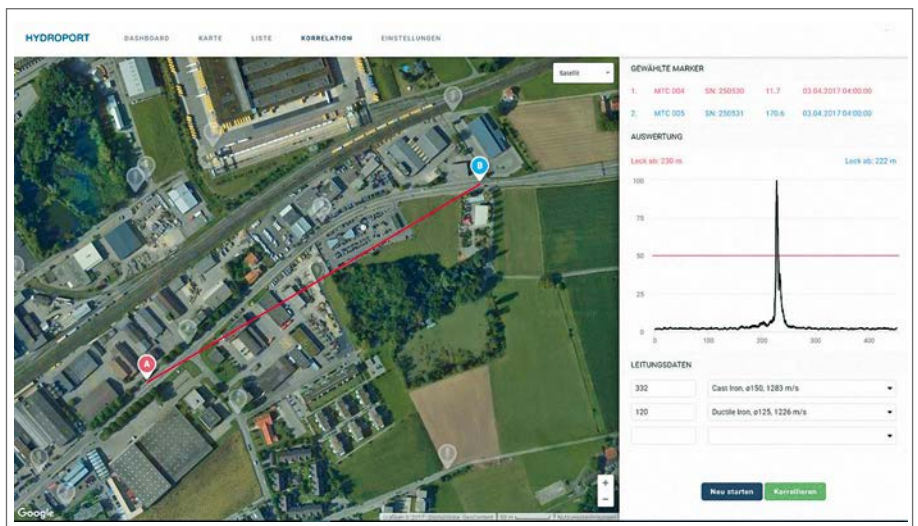

Leak detection with automatic correlation

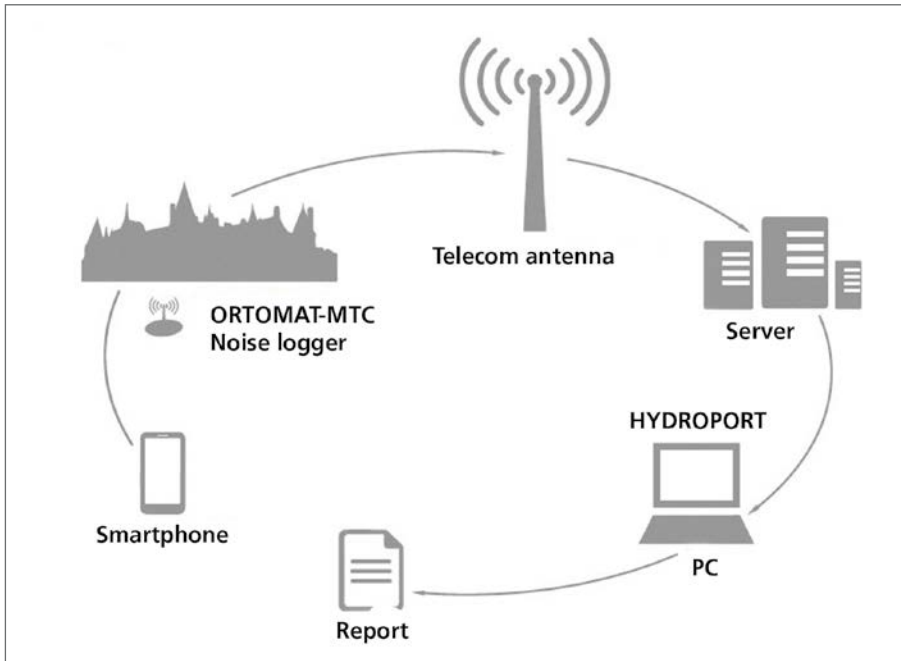

The water Internet: data acquisition – transmission – display/alerting

According to the analyses of network and damage statistics for water from DVGW [8] on supply pipelines for drinking water distribution, for ductile iron pipes with high-quality corrosion protection there is a damage rate of 0.01 incidents per kilometre per year. This damage rate is the lowest as compared with all other pipe materials used. At the same time this also means the lowest number of repairs, and hence of events which involve significant intervention in inner-city streets and traffic situations.

Ductile iron pipes have a long life. In DVGW Technical Guideline W 401 [9], ductile iron pipes have been assessed as having a technical working life of 100 to 140 years. In the end, this means that the servicing and maintenance expense necessary for piping systems in ductile cast iron is very low and hence sparing on the renovation budget.

Because of the long technical working life of cast iron pipe systems – and as compared with other pipeline materials – the replacement cycle is considerably longer.

This offers economic and ecological advantages: reinvestment and renovation budgets can be considerably lower with the use of ductile iron pipes and CO<sub>2</sub> emissions are significantly reduced.

### Resource conservation by intelligent system monitoring

Once the planning and construction stage is over, drinking water and sewerage networks operate for decades. The central tasks for the network operator are therefore secure operation, servicing, maintenance and, at the end, deciding on the renovation and/or replacement of complex networks and equipment. Throughout the entire period of operation, human, machine and energy resources must be used in the best way possible. In future, digital solutions will be supporting network operators more and more in the accomplishment of this challenging task.

With the HYDROPORT service portal [10] vonRoll hydro has created a possibility for small, medium-sized and large water supply companies to use the

Internet for water management. HYDROPORT is a software product which combines data collection, data management, working processes, monitoring tasks and quality assurance. Previously, hydrants and valves were at the centre of water supply in each case. However, the software can also be used for digitising the entire infrastructure of supply and disposal companies. Hence, these days, interfaces are already a standard part of geo-information systems (GIS), buildings insurance and other systems. With HYDROPORT it is possible, for example, to display when and where maintenance is required.

Control results or inspection work can be stored directly. The software links supervisors, service engineers and administration to each other so that work is efficient and coherent and everyone knows what is happening at all times. The ORTOMAT leak detection system can already be integrated into the HYDROPORT portal today. By means of a correlation system, any leaks in the pipeline network are located with pinpoint accuracy and displayed on the HYDROPORT service portal so as to minimise water loss in the network.

With its HYDROPORT platform, vonRoll hydro is now opening the doors to the Internet of Water. The term "Internet of Water" with the HYDROPORT software is the digital response to the need – which will be growing in coming years – for a reliable water supply and a sensible and sustainable optimisation of networks. www.idw.world has been brought into being as a comprehensive web application for the digitisation of infrastructures.

## Conclusion

Ductile iron pipe systems have been developed in a way which is compatible with the environment and with recycling and resource-saving production processes, materials cycles and the substitution of primary raw materials make a decisive contribution to the reduction of CO<sub>2</sub> emissions. Ductile iron pipe systems are more modern than ever because they meet the requirements of the future for resource conservation and environmental protection. They offer secure, trouble-free network operation and are characterised by a long working life. Ductile cast iron is a material which can be used in many areas of pipeline technology and, because of its superior technical properties, can guarantee long-term security in all areas. Ductile iron pipe systems offer long-term cost advantages and are a real factor in sustainability. Intelligent software solutions such as the HYDROPORT service portal support the sustainable security of piping systems and so contribute to resource conservation and efficiency.

## Bibliography

- [1] [www.cop23.de/bmub/klimapolitik-der-bundesregierung/](http://www.cop23.de/bmub/klimapolitik-der-bundesregierung/) date: 10.01.2018
- [2] [www.umweltbundesamt.de/themen/abfall-ressourcen/ressourcenschonung-in-der-umweltpolitik](http://www.umweltbundesamt.de/themen/abfall-ressourcen/ressourcenschonung-in-der-umweltpolitik) date: 10.01.2018
- [3] Directive 2008/98/EU: DIRECTIVE 2008/98/EC OF THE EUROPEAN PARLIAMENT AND COUNCIL of 19 November 2008. on waste and repealing certain Directives
- [4] [www.effizienz-mit-stahl.de/wp-content/uploads/2015/07/Energiewirtschaft\\_V1.pdf](http://www.effizienz-mit-stahl.de/wp-content/uploads/2015/07/Energiewirtschaft_V1.pdf) 2013
- [5] Gabler Wirtschaftslexikon, keyword: Cradle-to-Cradle, [www.wirtschaftslexikon.gabler.de/Archiv/222058/cradle-to-cradle-v6.html](http://www.wirtschaftslexikon.gabler.de/Archiv/222058/cradle-to-cradle-v6.html) Springer Gabler Verlag (publisher)
- [6] ISO 14001:2015 Environmental management systems – Requirements with guidance for use 2015
- [7] Rammelsberg, J.: Gussrohr-Verbindung TYTON® – Konstruktion – Typ-Prüfungen – Langzeiterfahrungen Submission to the Oldenburg Pipeline Forum 2003
- [8] energie | wasser-praxis 3/2017 – Petra Maler (Berliner Wasserbetriebe) & Frank Dietzsch (DVGW e.V.) – DVGW Network and damage statistics for water – results for years 2013 to 2015 [in German],
- [9] DVGW Technical guideline W 401:1997-09; Decision support for the rehabilitation of water pipe networks
- [10] [www.idw.world](http://www.idw.world) Webanwendung zur Digitalisierung von Infrastrukturen, vonRoll hydro (suisse) ag

## Authors

### Dipl.-Ing. Steffen Ertelt

Duktus (Wetzlar) GmbH & Co. KG  
Sophienstraße 52 – 54  
D-35576 Wetzlar  
Phone: +49(0)6441 491267  
E-mail:  
[steffen.ertelt@duktus.com](mailto:steffen.ertelt@duktus.com)

### Dipl.-Ing. Christoph Bennerscheidt Dr.-Ing. Jürgen Rammelsberg

EADIPS FGR  
European Association for  
Ductile Iron Pipe Systems /  
Fachgemeinschaft Guss-  
Rohrsysteme e. V.

Doncaster-Platz 5  
D-45699 Herten  
Phone: +49(0)2366 9943905  
E-mail: [c.bennerscheidt@eadips.org](mailto:c.bennerscheidt@eadips.org)  
[j.rammelsberg@eadips.org](mailto:j.rammelsberg@eadips.org)

Jürgen Rammelsberg

# The production and use of hydrants in spheroidal graphite cast iron

Hydrants are the internal shut-off devices in central water supply networks. They make firefighting possible but also public users (e.g. road maintenance and urban departments) and private users (e.g. street cleaning companies and open-air festival organisers) to take water from the public water supply network (communal water supply). In addition, they serve operational purposes such as the flushing and ventilating of piping network. They enable drinking water to be drawn directly from the supply network. Possible fields of application for hydrants are:

- taking off extinguishing water
- ventilating pipelines
- flushing piping networks, particularly in end sections for reasons of hygiene
- producing temporary network connections
- emergency water take-off
- short-term water supply, e.g. for construction purposes, funfairs, etc.
- bridging for emergency supplies
- drainage of pipelines
- leak detection

Depending on the position of the outlet opening, a distinction is made between underground and pillar hydrants. Pillar hydrants are preferable for firefighting purposes; they are easy to find, easily accessible and ready for operation at all times. However, in densely built-up areas and in narrow streets with heavy traffic, underground hydrants have to be used and their location must be identified with indication plates.

As it must be assumed that the wide range of users of hydrants will have different qualifications, high requirements are set for construction, ease of operation, ease of maintenance and operational safety:

## Low flow resistance

- A hydrodynamically efficient construction of the shell and valve body
- Minimum flow rate at 1 bar pressure difference ( $K_v$  value): pillar hydrants as per Table 4 of EN 14384 [1] between 30 and 300 m<sup>3</sup>/h and underground hydrants
  - 60 m<sup>3</sup>/h for DN 80 and
  - 75 m<sup>3</sup>/h for DN 100

## Pressurised water tightness

For hydrants with automatic drainage, the main shut-off device must be closed before the drainage device opens or the drainage device must be closed before the main shut-off device opens.

## Low residual water volume

Permissible residual water volumes for automatic drainage devices in accordance with EN 14384[1] and EN 14339 [2]. The maximum permissible residual water volume after draining pillar and underground hydrants in accordance with EN 1074-6 [3] is between 100 ml and 200 ml.

## Protection from roots

The drainage opening must be protected against root penetration, e.g. with a 50 mm dry section beneath the drainage point as per DVGW test specification VP 325 [4].

## Actuating the main shut-off device

In accordance with EN 1074-6 [3] the maximum actuation torque values stated in the following table apply:

DN	Actuation torque [Nm]
65	85
80	105
100	130
150	195

## Protection of the stem seal

Protection against the ingress of surface water and dirt above the seal (O-rings).

## No deadwater spaces

All parts which come into contact with drinking water must be within the flow zone during opening or when in the open position.

## Materials and coatings

Valve shell parts are generally constructed in spheroidal graphite cast iron to EN 1563 [5] and steel. In accordance with EN 14384 [1] other materials are also permissible. For example, upper sections in aluminium are also available. PUR (polyurethane) and EPDM (ethylene propylene diene monomer) are used as materials for shut-off elements.

## Corrosion protection

### Epoxy coating

The epoxy coating of valves has meanwhile developed into the standard coating for all valves in the area of untreated water, drinking water and wastewater.

In addition to the use of high quality epoxy lacquers, for valves the environmentally friendly, solvent-free epoxy power coating, also called (EP) coating has become particularly popular.

**Enamel coating**

As an outstanding and durable corrosion protection, enamel has been established in the area of water supply for more than 50 years. Since the end of the 1990's enamel has started to be applied on top of the external coating in order to produce an integral, continuous coating. As regards the material,

the production technique and the testing technique, a proven and self-contained "complete enamel" coating system has been available for several years and it has now found its way into practical applications in the area of transporting raw water, drinking water and wastewater.



Pillar hydrant – upper part in aluminium



DN 100 pillar hydrant – 2 B outlets 2



Design examples – DN 100 pillar hydrant – 2 B outlets, 1 A outlet with flanged joint



Tunnel hydrant with adjustable height, inlet bend and assembly base



Tunnel hydrant with a hand-wheel as the operating element

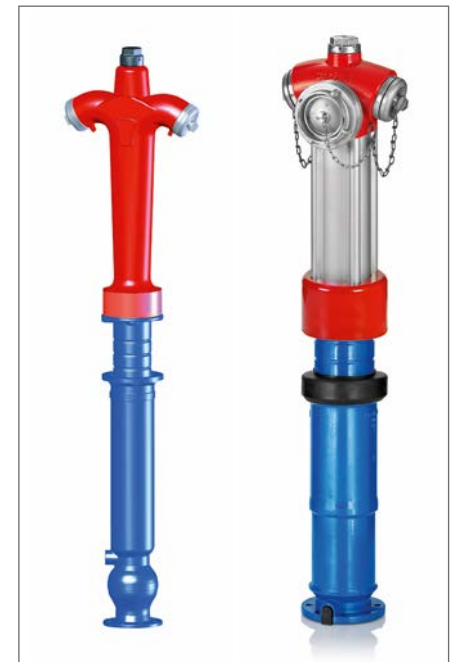

DN 100 pillar hydrants with flanged joint – height-adjustable bottom part



DN 100 pillar hydrant:  
2 B outlets and 1 A  
outlet with stainless  
steel column



Examples of DN 100 pillar hydrants with 2 B outlets and 1 A outlet  
with closed drop jacket



Pillar hydrant with  
open drop jacket: 2 B  
outlets and 1 A outlet

## Pillar hydrants

Pillar hydrants used in the public water supply system must meet the requirements of EN 14384 [1], EN 1074-1 [6], EN 1074-6 [3] and other national regulations where applicable such as DVGW work-sheet W 386 (P) [7].

### Construction

Pillar hydrants project above ground level and have a main shut-off valve and one or more water take-off points.

Pillar hydrants consist of two parts: the bottom section of the hydrant which contains the main valve and is installed underground plus the top part of the hydrant which is generally flanged onto the bottom part at ground level.

Pillar hydrants are equipped with a predetermined breaking point which is normally located in the connection flange between the top and bottom parts of the hydrant.

This protects the bottom part of the hydrant and the pipeline to which it is connected.

The majority of pillar hydrants are in nominal sizes DN 80 and DN 100, designed for an allowable component operating pressure PFA = 16 bar. They have a vertical or horizontal inlet with a flanged, push-in or spigot end joint. The pipe covering usually varies between 1.25 m and 1.5 m. This ensures that, even with a minimum volume of residual water, the main valve cannot freeze up. Shallower pipe coverings down to a minimum of 0.2 m can be found in tunnels with restricted space.

The bottom part of hydrants is normally designed for a fixed depth of pipe cover. In Switzerland, the majority of hydrants have height-adjustable bottom parts. Pillar hydrants differ in the type of protection of their B outlets – without drop jacket or with drop jacket.

The picture below shows a pillar hydrant without a drop jacket with B outlets which can be closed off. Operation is by hydrant keys which are specific to individual regions.



The upper part of a pillar hydrant without drop jacket with B outlets which can be shut off



Pillar hydrants can have single or double shut-off devices. The double shut-off version is usually a ball or cone design.

### Connection options

Pillar hydrants are used in different piping and pipe joint systems. Different joints are available for these:

- Hydrant with flanged joint,
- Hydrant with spigot ends and various restrained joint systems (Novo SIT®, TY- TON SIT PLUS®, BLS®, VRS®-T, BAIO®, vonRoll HYDROTIGHT, threaded sockets or similar).

## Underground hydrants

Underground hydrants used in public water supply systems must meet the requirements of EN 14339 [2], EN 1074-1 [6], EN 1074-6 [3] and other national regulations where applicable such as DVGW worksheet W 386 (P) [7].

### Construction

The majority of underground hydrants are in nominal sizes DN 80 and DN 100. They are usually housed in surface boxes in the road as per DIN 4055 [8] and can be operated from there. A stand-pipe according to DIN 14375-1 [9] is always required in order to take off water and this is connected to the locking claw. In addition to the locking claw connection there are also different types of connection specific to the individual region; in Switzerland, for example, there are also round-thread connections.

The main shut-off device is actuated by applying a hydrant key. The design of the hydrant key varies from region to region, e.g. in accordance with DIN 3223 [10].

Underground hydrants consist of a one or two-part shell, also referred to as a jacket pipe or standpipe, the lower part of which houses the shut-off device. The opening movement may be against or with the direction of flow.

Underground hydrants can have single or double shut-off devices. The double shut-off version is usually a ball or cone design. The double shut-off version has the advantage that the shut-off device including its drive elements can be replaced in the surface box with the pipeline under full pressure. When hydrants with a double shut-off system are used there is no need for an up-stream gate valve.

As underground hydrants are usually located in surface boxes there is the risk that, with insufficient maintenance and in unfavourable locations (road subsidence) road grit, stones or other small objects may get into the shell and damage the shut-off device.

In order to minimise this risk, two systems are used in the area of the locking claw: sealing flap and cover.

### Connection options

Underground hydrants are used in different piping and pipe joint systems.

Different joints are available for these:

- Hydrant with flanged joint
- Hydrant with spigot ends and various restrained joint systems (Novo SIT®, TY- TON SIT PLUS®, BLS®, VRS®-T, BAIO®, vonRoll HYDROTIGHT, threaded sockets or similar)

### Industrial hydrants

The field of application for industrial hydrants, as the term suggests, in industrial plants, power stations, airports and any locations where large volumes of extinguishing water are required.

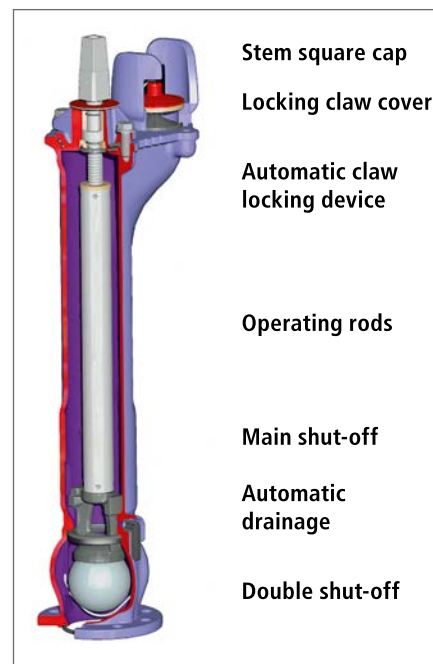

DN 80 underground hydrant: double shut-off, opening against the direction of flow – coating with epoxy resin powder



DN 80 underground hydrant: double shut-off, opening against the direction of flow – fully enamelled



Industrial hydrant for extinguishing water supply at airports



Industrial hydrant for extinguishing water supply on industrial premises

### Author

**Dr.-Ing. Jürgen Rammelsberg**

EADIPS FGR  
European Association for  
Ductile Iron Pipe Systems/  
Fachgemeinschaft Guss-  
Rohrsysteme e. V. Doncas-  
ter-Platz 5  
D-45699 Herten

E-mail:  
j.rammelsberg@eadips.org

### Bibliography

- [1] EN 14384  
Pillar fire hydrants  
2005
- [2] EN 14339  
Underground fire hydrants  
2005
- [3] EN 1074-6  
Valves for water supply Part 6:  
Hydrants  
2008
- [4] DVGW-Prüfgrundlage VP 325  
Hydranten in der  
Trinkwasserverteilung  
2008-01
- [5] EN 1563  
Founding – Spheroidal  
graphite cast irons  
2011
- [6] EN 1074-1  
Valves for water supply –  
Part 1: General requirements  
2000
- [7] DVGW test specification  
W 386 (draft),  
Hydrants in drinking  
water distribution  
2014-01
- [8] DIN 4055  
Water pipelines;  
Surface boxes for under-  
ground hydrants  
1992-02
- [9] DIN 14375-1  
Standpipes PN 16;  
Standpipes 2 B  
1979-09
- [10] DIN 3223  
Handling keys for valves  
2012-11

## Renaturation of a stream in Villmergen with the help of cast iron pipes

The municipality of Villmergen in the Swiss canton of Aargau has had its own water supply since 1895. In the 1990's there were several heavy storms during which streams burst their banks causing damage running into millions. The flood protection plan included the renaturing of the Trybach which had been routed into a concrete pipe which was unable to cope with stormwater, thus resulting in flooding. In order to get the water running almost naturally again, the future stream bed was to be opened up and widened to allow a better flow of water. But before

doing this it was necessary to re-route a transport pipeline from the pumping station, as otherwise it would run under the new stream bed. This construction project involved the use of more than 200 m of vonRoll ECOPUR DN 400 ductile iron pipes with integral polyurethane coating and vonRoll ECOFIT epoxy-coated fittings. All connections were produced using restrained push-in joints from the HYDROTIGHT thrust protection system.



## Raw water pipeline linking two reservoirs

The Birkenfeld water association looks after the collection, treatment and distribution of an annual volume of 4.8 million m<sup>3</sup> water for 77,000 local residents.



In a renovation project, a ductile iron pipeline has been constructed between the Steinbach reservoir (in Rhineland-Palatinate) and the Prims reservoir in Saarland. The first stage involves pumping water from the Prims reservoir through a DN 500 pipeline up to the highest point at the Hattgenstein water tower. From there onwards it flows through a DN 400 double gravity pipe down to the Steinbach reservoir waterworks where it is used for generating electricity. The Erhard company was able to cover the broad spectrum of valves required for this and also supplied the technical calculations. In the context of this project, Roco wave type butterfly valves, plunger valves, check valves, ventilation valves and ball valves along with pipe-break safety devices with brake-and-lift units in DN 500 up to PN 40 were supplied.

## Magdeburg puts its trust in ductile cast iron with epoxy coating

For the purpose of supplying drinking water, the Magdeburg municipal utility company maintains 1,224 km of pipelines, of which some 360 km are in cast iron. For the construction measures carried out in 2016, Keulahütte supplied pressure pipe fittings, valves and hydrants with integral epoxy powder coating.

More and more users are opting for this coating when it comes to deciding on corrosion protection. With constant development of processes and materials, this type of protection has long since become established in pipeline construction. However, it is only with the all-over coating of valve parts that its full potential has been able to be put to best use for valves and hydrants. In conjunction with the process and quality parameters of the coating, this integral corrosion protection meets very high expectations as regards working life. In a once-through process, the components are blasted, cleaned, heated and then immediately coated with the greatest care.



Volker Börschel

# Modern epoxy powder coating for valves and fittings

Quality is the watchword for operators of gas and water supply networks. Good quality is a precondition for a long working life, lasting functional capability and hence the economical operation of pipeline networks. Epoxy powder coating protects against corrosion, ensures a long working life and is hygienic and perfectly safe for use in the supply of drinking water.

A characteristic of epoxy powder coatings is their long-term corrosion protection (achieved by good adhesion, absence of pores, resistance to various media such as chemicals, sewerage etc.) and their mechanical properties (impact resistance, bending properties, abrasion resistance, stability of form under the effects of external forces and heat).

Powder coatings were developed as far back as the 1960's. Over the course of time, increasing ecological concerns and stricter environmental requirements have led to continual improvements in powder coating technologies, in their application, in surface quality and in the powder material.

## Production of powder coatings

The processes for producing powder coatings are quite generally known. First of all, the resin, curing agent, pigments, fillers, additive and auxiliary materials have to be homogeneously mixed. Once the mixture is ready, it is fed into an extruder. The meltable parts of the mix are taken to their softening point range in the extruder – which is around 110 to 130°C depending on the type of extruder – and the non-meltable parts are homo-

geneously worked into the meltable part by the action of the rotating extruder screw.

As the melt leaves the extruder it is rolled out flat and then cooled to room temperature through one or more cooling rollers with a final cooling line. The cooled and solidified sheet of material is granulated to produce chips which are as even as possible in size.

The subsequent grinding process produces the powder coating from these chips and its grain distribution is individually adjusted to the requirements of the client in each case. With the grinding technology available these days, and particularly for the fluidised bed sintering process, powder coatings with extremely low dust levels can be produced.

## The coating process

The Resicoat® R4 range has been specially developed for the corrosion protection of ductile cast iron valves and fittings. These are mainly supplied in the water industry where they are usually buried underground. The Resicoat® R4 range is characterised by a high level of resistance:

- mechanical: impact, elongation, abrasion
- chemical: water, sewerage, acids, alkalis, gases
- electrical: stray currents (railways, transformer stations)

The coating process consists of pre-treating and pre-heating the workpiece, application of the powder and curing. Good pre-treatment of the workpiece is the essential prerequisite for high-quality coating. In general this is done by blasting it with steel shot. The surface of the workpiece must be free of oil, grease, salts and other impurities. Moulding sand and rust must be cleaned from the surface and graphite is to be removed by operating the equipment to its optimum. Sharp edges should be avoided on the castings. The workpieces should only be handled with lint-free gloves. The recommended blasting agent is sharp-edged steel shot or corundum with an average grain size of 0.4 to 1.0 mm and Rockwell hardness of HRC 55 to 65, plus a surface roughness Rz of 50 to 70 µm. Before further processing, dust must be removed with pressurised air. The shot-blasted workpieces must then be transported immediately to the pre-heating oven in the once-through process.

At the time of coating, the object temperature should be between 190 and 220°C. Conventional convection or infrared radiation at maximum 250°C ambient air for a maximum of one hour allow the workpiece to achieve a uniform surface temperature without oxidation. Before coating the workpiece should have a golden colour. Oxidised iron is to be avoided; this can be recognised by a blue/violet coloration. If general and higher requirements or specifications are to be met, the greatest care must be placed on avoiding oxidation.

The object temperature is the most important point for achieving the best possible surface cover. As the powder coating is only at its lowest viscosity for a short time, it is extremely important that coating takes place at precisely this time, before the cross-linking mechanism causes viscosity to increase again.

So, as soon as the workpiece has reached its pre-heating temperature, the coating process must start immediately. Too long a waiting time between leaving the oven and being coated must be avoided in all cases because the object temperature will then start to fall again.

The coating becomes compression-resistant relatively quickly after application and then cools to room temperature. Compression resistance is high as compared with thermoplastics.

### Application of the powder

The powder is applied using extremely modern process technology: coating is done either by the fluidised bed sintering process or by electrostatic application with a spray gun and this must happen in the shortest time and without interruption, ideally within the gelling time of the powder, in order to avoid overspraying (if a spray

gun is used) or to reduce the coating thickness (fluidised bed process). A coating thickness of 250 to 500 µm is recommended, with the recommended coating thickness for testing purposes being between 250 and 350 µm.

The fluidised bed sintering process is an automatic method in which robots dip the workpiece into a tank of fluidised powder. The process allows a high degree of reproducibility of coating thickness, edge coating and optical appearance.

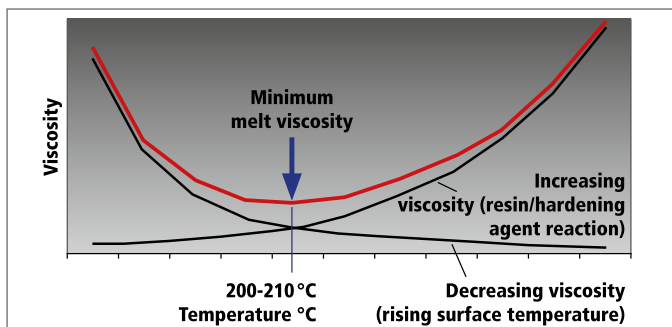

Relation between the object temperature of the powder and the covering capability

Test	Typical value	Method
Adhesion	> 25 – 40 MPa	GSK/DIN EN ISO 4624 [1]
Impact resistance	> 5 Joule	GSK/DIN 30677-2 [2]
Elongation	> 3 %	GSK/DIN 30677-2 [2]
Breakdown voltage	≥ 30 kV/mm	GSK/DIN 30677-2 [2]

Epoxy film properties of Resicoat® R4 on cast iron



Coating by the fluidised bed process





Application of a polyester powder as a surface layer on an epoxy coating by the electrostatic spraying process

With the electrostatic spraying process, the coating is applied manually. The process is suitable for coating large components and is flexible as regards changes of colour or material. The picture above shows the application of a thin polyester powder coating on top of an epoxy resin coating in order to avoid chalking when exposed to UV light.

Curing is achieved by means of the residual heat in the workpiece. There is a sufficient heat capacity in the workpiece with cast iron wall thicknesses of 6 to 8 mm. The degree of curing is checked by means of the MIBK test (methyl-isobutyl-ketone solvent). Any imperfections due to e.g. holding tools when coating or mechanical damage happening during transport and installation can be touched up using a 2-component repair material which, of course, is also approved for use with drinking water.

### GSK quality certification

The highest requirements are placed on cast iron pipes installed underground when it comes to corrosion protection. Pipeline network operators demand the very best quality and supply companies

look for the existence of the GSK quality seal. GSK, the quality association for heavy-duty corrosion protection of valves and fittings by means of powder coating, was set up in 1989 in order to fulfil the increasing requirements placed on pipeline networks in many European countries. Today GSK can count more than 30 member companies including manufacturers of valves and fittings from 13 countries in Europe and Asia, as well as a few powder coating producers.

The requirements set by GSK [3] go far beyond the relevant national and international standards [4], [5]. In order to ensure compliance with these requirements by the member companies, these are checked a number of times a year by an external test institute. This guarantees process reliability and high quality. The RAL quality mark, which is bestowed on its members by GSK, is a reliable gauge for developers, engineers, construction companies and manufacturers.

GSK checks the following requirements:

- coating thickness: min. 250 µm
- complete absence of pores: 3 kV high voltage dielectric strength testing
- adhesive pull strength of 12 N/mm<sup>2</sup> after 7 days of being kept in 90 °C hot de-ionised water
- drinking water suitability: test-based evidence according to the latest national and international requirements
- cathode infiltration after 30 days ≤ 10 mm
- impact resistance of min. 5 Nm
- complete cross-linking
- adhesion testing: this testing confirms the high surface adhesion of the epoxy powder coating on steel

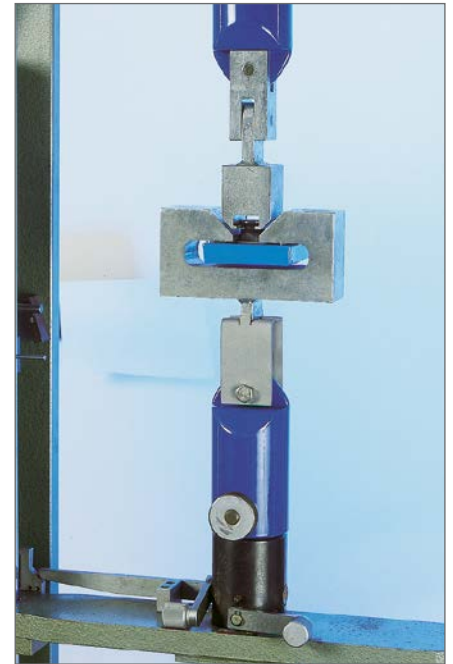

Method for testing the high surface adhesion of epoxy powder coating on steel

The testing of cathode infiltration, which is established in the GSK quality and testing requirements as well as in numerous other specifications, is used for assessing corrosion resistance and has been an industrial standard for many years.

The GSK quality level requires its participating member companies to undergo "external monitoring" twice a year by a neutral test institute. On these occasions, the internal quality controls of member companies and relevant production parameters are checked. Once a year, a collection of all the results are published within GSK in coded form in order to gain an overview of the quality level of GSK member operations.



Testing cathode infiltration

## Epoxy powder coatings in the field of drinking water

Epoxy powder coatings consist of the basic building blocks of hydrocarbon, oxygen, hydrogen and nitrogen. An epoxy powder coating formula generally includes the following four main components: binding agent (resin and curing agent), pigments, fillers, additives and, if necessary, auxiliary materials. Different epoxy resins are available depending on the properties required.

As regards curing agents, versatility of functions is possible. Examples to be mentioned here are amino-functioning curing agents and those containing phenol. Pigments and fillers are used to give colour and to increase the protective function. Fillers can also intervene in the spreading properties and hence improve processability. Additives and auxiliary materials can contribute to improving surface structure, the wetting of the substrate and ease of processing for clients.

## Physiological properties of epoxy powder coatings

The hygiene of drinking water has highest priority. Therefore, it must be guaranteed that no harmful substances will get into the drinking water from the coatings. A drinking water approval is based on the European epoxy resin directive with a comprehensive positive list of toxicologically evaluated substances.

In Germany, drinking water suitability is tested according to different areas of use. In general, powder coatings are tested according to criteria for valves and fittings. In addition, Resicoat® R4 powder coating is tested for use in pipes for which, because of the less favourable surface-volume ratio, considerably stricter limit values apply.

The Resicoat® R4 series has been approved in almost all European countries for contact with drinking water, among others according to the directives of the Federal Environment Agency (UBA) and for bacteriological safety according to DVGW worksheet W 270 [3] (Germany), ACS (France), WRAS & WIS 4-52-01 [6] (Great Britain), KIWA (Netherlands), Belgaqua (Belgium), SSICA (Italy), OTEC (Spain). The material also has drinking water approvals on other continents such as in the USA (NSF 61 [7]), Brazil and Australia. In addition, Resicoat® R4 has been listed according to WIS for industrially produced epoxy resin for coating pipes.

In Europe, products are tested for the drinking water area by independent test institutes and in some cases approved by national authorities. In a few countries such as France and Germany there are positive lists which ensure that only selected raw materials are used for the drinking water area.

Some countries send out their auditors to the manufacturers of coating materials in order to check their processes and the purity of their materials. In addition, samples are taken from current production and regular toxicological tests are performed.

These tests and inspections are typical for Europe and they concentrate not only on the corrosion protection of epoxy coatings but also on the effects of the coatings which occur on contact with drinking water.

From a physiological point of view, epoxy powder coatings are very well suited to meeting the criteria required in the various approval regulations without problem. This includes e.g. smell, taste, cloudiness and clarity tests of the water in contact with the epoxy systems, which in no way affect the drinking water. In addition, the various drinking water institutes carry out eluate investigations (determining the proportion of water-soluble substances) on the basis of different possible chemical building blocks.

In most cases, despite today's sophisticated analysis technology which is able to go into the ppm range, no detection is possible. In France, on the basis of various screening tests, investigations are carried out into mercury, cadmium, selenium, antimony, chromium, arsenic, lead and nickel and various polycyclic aromatic (PAH) and organic halogen compounds.

In the Netherlands, the KIWA organisation carries out audits with powder coating producers at regular intervals in which it tests the quality of the products. Also, every three years, these products undergo toxicological verification. For this, stainless steel plates are coated and then kept in water for different lengths of time. This water is then tested for possible migration products. American drinking water institutes tried unsuccessfully to detect around 50 different chemical building blocks in water which, at different temperatures, pH values and exposure times, was in contact with epoxy powder coatings. Also, the detection of different metal ions remained without effect because the modern, environmentally friendly Resicoat® powder coatings manage without such harmful metal compounds.

As well as these analytical investigations, epoxy powder coatings also have to pass microbiological tests. They are examined according to the specifications of DVGW worksheet W 270. According to this, the microbiological behaviour is assessed over a period of three months in unchlorinated water. As can be seen in the W 270 certificates, the epoxy powder coatings are most suitable for use in the drinking water area from a microbiological viewpoint.

Relatively new are approvals for gas and biogas, making a more far-reaching use of epoxy coated valves and fittings possible in modern gas equipment.

## REACH conformity

The REACH (Registration, Evaluation, Authorisation and Restriction of Chemicals) regulation no. 1907/2006 [8] is a new EU directive for the safe handling of chemicals. The regulation, which came into effect on 1st June 2007, was transposed into the national law of all EU member states with immediate effect. The REACH regulation demands that industry itself assumes responsibility for the risks of all chemicals introduced by it into the EU. As far as raw materials are concerned, the Resicoat® R4 range complies with REACH.

To summarise, it can be said that fittings and valves coated with epoxy powder

- offer reliable corrosion protection and resistance to the widest range of chemicals,
- have a long working life,
- have numerous approvals for drinking water, gas and biogas,
- are cost effective as scarcely any losses occur and
- are environmentally friendly as they are free of solvents and heavy metals.

### Author

**Dr. Volker Börschel**  
Global Segment Manager  
Functional Powder Coatings

Akzo Nobel Powder Coatings  
GmbH Markwiesenstraße 50  
D-72770 Reutlingen  
Phone: +49(0)7121 519-145  
E-mail: drvolker.boerschel@akzonobel.com

## Bibliography

- [1] DIN EN ISO 4624: Coating materials – Pull-off test for assessing adhesion
- [2] DIN 30677-2: External corrosion protection of buried valves
- [3] DVGW worksheet W 270: Enhancement of microbial growth on materials in contact with drinking water included in DIN EN 16421: Influence of materials on water for human consumption
- [4] RAL-GZ 662: Schwerer Korrosionsschutz von Armaturen und Formstücken durch Pulverbeschichtung [Heavy duty corrosion protection of valves and fittings by powder coating]
- [5] EN 14901: Ductile iron pipes, fittings and accessories – Epoxy coating of ductile iron fittings and accessories
- [6] WIS 4-52-01: Specification for polymeric anti-corrosion (barrier) coatings. Water Industry Specification December 1992
- [7] NSF 61: Drinking Water System Components. NSF-International
- [8] European Parliament and Council Regulation (EC) no. 1907/2006 of 18.12.2006 concerning the registration, evaluation, authorisation and restriction of chemicals (REACH) and establishing a European Chemicals Agency 1999/45/EC



## Ductile iron pipes installed with the burst lining technique

The Offenbach water supply association supplies 14 towns and communities with water. Because of numerous incidences of damage to the long-distance water pipeline, asbestos cement pipes have been replaced. DN 200 ductile iron pipes from Duktus with cement mortar coating and restrained push-in joints were used for this. The construction site is located in a landscape conservation area, meaning that part of the pipeline needed to be installed using the burst lining technique.



In addition, this meant that around 50% of costs could be saved. With trenchless installation, the pipes are exposed to external mechanical loads. This also applies to burst lining, as broken pieces of the old pipe come into contact with the new pipe while it is being pulled in. Cement mortar coatings protect the pipes from damage. In total 1,900 m was replaced using the burst lining process. The longest pipe string consisted of 28 pipes and was 168 m long. A number of interested people took the opportunity of having the pulling-in of restrained ductile iron pipes explained on site.

## Renovation of the sewage system in Ischgl



Ischgl is booming – and has been so since the opening of the Silvretta cableway back in 1963. By 1976 the community had achieved the highest capacity of all winter sports regions in Austria. So that Ischgl can remain one of the most popular winter holiday destinations in the Tyrol in future, the infrastructure of the sewage system also needs further development alongside the development in tourism. It has long been known that the sewage system belonging to the municipality and the wastewater association is defective. Whenever there was heavy rainfall, hydraulic capacity was being exceeded. In 2013 the community of Ischgl decided to recalculate the hydraulic situation of the sewage network and embark on structural renovation. This included the replacement of pipes in the diameter range from DN 250 to DN 1000. The construction area is mainly located in Alpine terrain. This fact, together with the deep position of the pipes with groundwater all around resulted in some high requirements for the piping system. Therefore infiltration-proof pipes in ductile cast iron supplied by TRM were used over a length of 800 m.

## Fresh drinking water for two million Hamburg citizens

Hamburg operates a drinking water network of around 5,400 km, along with a correspondingly large number of shut-off valves. These days it is standard for valves as from DN 400 to be equipped with a bypass which can be closed off to allow the filling and draining of pipelines without any pressure shock and also to discharge air during the filling process. The experts from the network operator were aware of the longer-design valves supplied by Düker. During a visit to the valve production centre in Laufach, they also discussed the use of a DN 600 valve. As this is located at a high point, the plan was to install a device for venting the pipeline. A special solution was found for this: a shut-off valve



for a nominal pressure of 16 bar in the longer design with two DN 80 block flanges on top to provide ventilation before and after the valve seat. This compact system makes filling and draining possible without pressure shock via a hydrant bridge, as well as manual venting and aeration via the standpipe and venting with the use of hydrant air vents.

Frank Endreß

# Digitisation in the water supply industry

Yesterday, today and tomorrow

One thing is certain: digitisation will not stop short of the water management sector – sooner or later, it's going to happen!

And another thing is clear: when it comes to drinking water quality and security of supply, German water suppliers are absolutely top class. But it is also clear that in future it will be considerably more difficult to continue to maintain this position. Climate warming, nitrates and other pollutants, the effects of heavy rainfall events or simply the need for the further development of effective processes and procedures; these are all subjects which require open-mindedness when tackling the subject of digitisation.

## Digital technology has already been here a long time

We only need to look a little closer at the technology to see that we have already been dealing with digital applications for quite some time now. Just the example of the first remote-reading water meters, which have been around for 20 years, will demonstrate the development of digitisation. At the time, pulses were still being counted and then read out via cable links, but later M-Bus protocols became established and a two-way communication of accurate meter readings was possible, at first by cable and shortly afterwards via the first 433 MHz short-range radio systems.

The first stage involved the remote reading of meters in shaft structures, because the effort of reading the meters in the shaft by eye was obviously considerably higher.



Remotely readable water meter with a two-way 433 MHz short-range radio module



Reading a remote read-out water meter; no more need to climb into the shaft

Two-way short-range radio systems had the disadvantage that it was always necessary to be in the vicinity of the building in order to “wake up” the radio modules.

In stage two, and based on the two-way systems, a one-way system in the 868 MHz band was developed. The advantage here was that the meters could be read either with the “drive-by” process or even from a fixed point. These systems were extended to all types of energy, and so the first Smart Metering systems were born.

These days there are water flow meters based on static metering principles, offering outstanding measuring characteristics no

matter where they are installed, which can accurately assess forward and backward volumes and detect leaks in home installations and which have an internal power supply which ensures that the metering and communication tasks are carried out across at least two calibration periods.

With the installation of cryptographic chips, communication meets the BSI standard (BSI = Federal office for information security), which means that data transmission has the best possible safeguards against misuse.

But even in the area of water meters, progressive digitisation has shown that there is a considerable potential for optimisation. When testing “wet-running” meters, there is normally a small amount of testing water left in the meter. This can result in *Pseudomonas aeruginosa* bacteria becoming established in the meter.

It is only in recent years that this germ has been able to be successfully detected and manufacturers had to improve their production processes in order to check for the absence of germs.

In the area of leak detection, mobile measuring systems have been used for many years now in place where a leak might be suspected, for example because of consumption during the night.

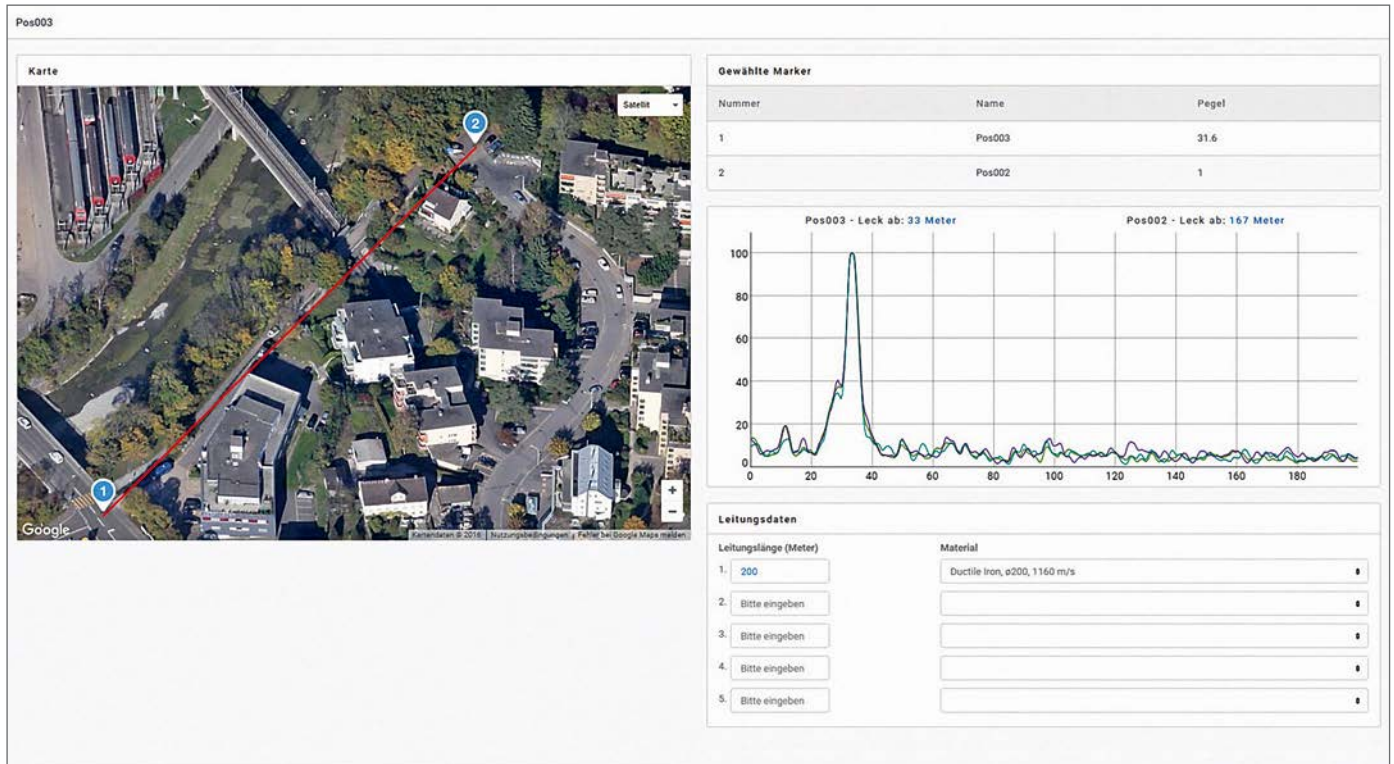

Example of a running-time correlation measurement between two metering points. The distance of the leak between metering points 1 and 2 is indicated in each case

If then loggers then pick up indications in the structure-borne noise which suggest that there is a leak, then correlation technology can be used to determine the precise position of the leak on the ground. In this way, the location of the damage can be revealed with pinpoint accuracy. There are systems on the market today which, by making a precisely timed comparison of two stationary metering points, can perform a close correlation from the screen and then display the leak on a map via Google Maps.

It is now only a question of time until it also becomes possible to measure parameters in urban distribution networks such as temperature, pressure, conductivity, cloudiness etc. online and then transmit the data across corresponding standardised networks, such as the already current GSM (Global System for Mobile Communications) or then also via LoRa WAN (Low Range Wide Area Network) or IoT (Internet of Things).

### It's time to tackle the digital basics

However, if the actual autonomous structures are to be cross-linked, it will first be necessary to change some processes and procedures. EADIPS FGR, with a Digitisation working committee, is specifically campaigning for the standardisation of the traceability of all components in the network, including those buried underground. Therefore, the technology needs to be addressed here and now so that it allows a pipe installed underground to be accurately identified, e.g. by a radio-transmitted serial number.

In the same way, this must also still be possible in, say, 100 years from now. Thus, we want to ensure that the traceability of products is secured, starting from the production process, then going on into the logistics process right through to installation and use.

With components buried underground it is simply not enough to apply a serial number manually and hope that, when a supplier wants to know precisely what is lying in the ground, he will excavate at the right place. A standard needs to be developed which is used by all manufacturers and results in process simplification throughout the entire supply chain. Without such standardisation of the basics one can scarcely start thinking about more far-reaching process in the field of digitisation.

In the Internet of Water there are already applications today which engage directly in business management and with which it is possible, for example, to organise and account for the maintenance and servicing of all components.



Classic und smart meters for various applications  
(left to right): water, heat, power and gas

Equally, the precise location of all metering points can be documented and analysed on the same platform in Google Maps. This means that leaks, water temperature or any other parameters needed can be displayed directly on the screen. If readings go above or below upper or lower limits, a corresponding alert can be triggered.

### Digitisation will not replace the human expert

Naturally it is also important in the age of digitisation that our water specialists know exactly what their supply system is doing and can use the additional data and their own knowhow to make the right decisions at the right time.

Therefore, nobody needs to be anxious about digitisation; they should use the tools resulting from it so that the most precious of all resources can be supplied in future in the same high quality as it is today.

What is more, particularly for generations y and z, who to date have been involved in a working process which tends to be based on technical operations, digitisation is growing in a direction which they grew up with and in which they feel at home.

So companies which are already finding themselves competing for suitable specialists will be able to gain a decisive advantage from digitisation.

### Autor

**Dipl.-Betriebsw. (FH)  
Frank Endress**

Spokesman of the EADIPS  
FGR Digitisation Working  
Group

Head of the Digitisation  
Committee at EADIPS FGR

Senior Consultant  
Duktus (Wetzlar) GmbH  
und Co. KG  
Sophienstr. 52-54  
D-35576 Wetzlar  
Mobile: +49(0)173 9150915  
E-mail:  
frank.endress@duktus.com

## Structural indicators of the German foundry industry

Reference	2016	1995
Cast iron production	3,919,000 tonnes	3,496,000 tonnes
Employees	approx. 43,000 Employees	approx. 53,000 Employees
Number of foundries	242 foundries	374 foundries
Cast iron production per employee	91 t/employee	66 t/employee
Cast iron production per foundry	16,194 t/year	9,348 t/year

Comparison of figures from German iron foundries 2016 to 1995

Cast metal components are not used solely for the transport of fluids, in particular of water and wastewater. All around the world cast iron components can be found in almost all branches of industry. The reasons for this are many and various. Among them are e.g. the mechanical properties of the various cast materials and the fact that, when in the liquid state, metals can take on almost any geometrical form desired and be very strong once they have cooled.

Traditionally, a distinction is made between two main groups of materials – cast ferrous materials and cast non-ferrous materials. For cast iron pipe systems, the non-ferrous materials play an entirely subordinate role. Therefore, the information below on the structural indicators of the German foundry industry concentrate on foundries producing iron, steel and malleable cast iron, in other words ferrous materials. The table illustrates their development by comparing the figures for 1995 and 2016.

In 1995 the structural adaptations of the East German foundries as a result of altered economic framework conditions were largely complete and 374 ferrous foundries produced approximately 3.5 million tonnes of iron, steel and malleable cast iron, with around 53,000 employees. In 2016, 242 ferrous foundries produced approximately 3.9 million tonnes of cast ferrous

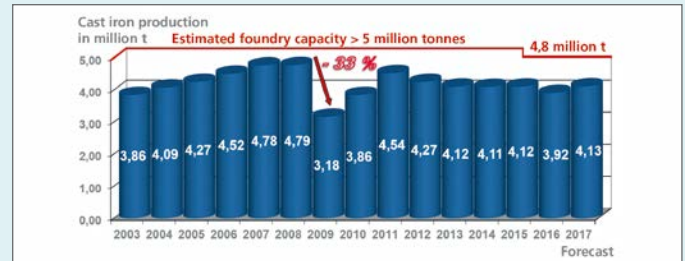

Production development in German iron foundries

materials, but now with only around 43,000 employees. The average production of cast iron per foundry thus increased by 6,846 t/yr from 9,348 t/yr to 16,194 t/yr. This process of concentrating cast iron production gave Germany a leading position in the world.

With around 4.8 million tonnes, the foundries producing iron, steel and malleable cast iron achieved the highest production of all times in 2008. Almost all foundries were delivering at capacity limits, so it is relatively safe to assume a total capacity of around 5 million tonnes. Worldwide, with a forecast 4.13 million t/yr in 2017, the German iron and steel foundries take fifth place after China, India, USA and Japan. However, the picture also shows what the main task of the ferrous foundries is: solutions must be found in order to increase the utilisation rate of the ferrous foundries in coming years as otherwise there is a danger of the closure of foundry operations.

Mario Mackowiak

Managing Director of Keulahütte GmbH, Chairman of the Supervisory Board of the East State Association of the Federal Association of the German Foundry Industry.

Source: Bundesverband der Deutschen Gießerei-Industrie (BDG) Düsseldorf

## 30 years of snow-making equipment with cast iron pipe systems

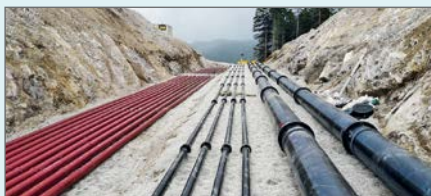

The need for snow-making equipment continues to grow. Planners and operators in Alpine ski resorts require robust, reliable and easy-to-handle piping systems for this. These criteria are best met by ductile iron pipe systems with restrained push-in joints. In 2019 Seefeld in the Tyrol is, for the fourth time, to be the venue for the Nordic Ski World Championships. For this event, the snow-making equipment is to be expanded further. More than 3,300 m of ductile iron pipes in nominal sizes DN 80 to DN 400 will be used for the storage reservoir and the snow cannons. In the ski resort of Ischgl, the snow-making equipment will be installed at the reservoir lake at an altitude of 2,300 m. This will be connected to the existing snow-making system with cast iron pipes in nominal sizes DN 80 to DN 400. This project represents an investment of about 4.5 million euros.

Uwe Hoffmann und Lutz Rau

# Interim pipelines in ductile cast iron are the best

Secure, economical, quick to install and reusable

When supply pipelines or sewage systems still in operation need to be replaced, renovated or even repaired, the engineering involved for ensuring a secure supply or disposal service in the meantime is not to be under-estimated. In branched local networks supplying drinking water, the section concerned can usually be closed off and the water diverted away from the area affected by a bypass.

After a new construction however, it must be borne in mind that the time windows for connecting up a new section are small. But shutting down and diverting is often not possible, and pipelines laid below ground (e.g. in gravity sewers) or above ground, referred to as "flying" or interim pipelines need to be constructed so as to be able to continue transporting the media in question while the work is being carried out.

In normal usage, these interim pipelines are often seen as workarounds. However, the term is more appropriately interpreted as temporary engineering works which need to be planned, constructed and operated in their own right.

## Rules and practical examples

To date there are no generally applicable requirements for the planning, construction, operation and deconstruction of interim pipelines, meaning that as a rule technical solutions have been worked out as each individual case arises.

Information on the construction of pipelines above ground and on special requirements for piping systems constructed above ground can be found in DVGW W 400-2, chapter 15.2 [1], EN 805 [2], chapter 5.4 (protection of systems) and in the draft of prEN 598 [3].

DVGW work sheet W 400-2 applies to the construction and testing of water distribution equipment for drinking water supply. Chapter 15.2 describes additional requirements for the construction of pipeline systems above ground. There are descriptions of the requirements for pipe joints, the installation of pipeline components, thermal insulation, corrosion protection etc. through to pressure testing and commissioning. Basically, the requirements described there are to be observed when planning interim pipelines.

In EN 805 [2] from the year 2000 there is the following statement: With respect to terrorist attacks, vandalism and other illegal acts, keen attention is to be paid to the protection of water supply systems. Underground systems are safe in general, but particular attention needs to be paid to sections of pipeline above ground.

As a possible consequence, the fire behaviour of structures has been included as an essential characteristic in the die EU regulation for determining harmonised conditions for the marketing of construction products. This also relates to pipe systems which, in future, must be assigned to fire classes [4].

But also, different network operators have many years of experience in the use of ductile iron pipe systems as interim pipelines which can be drawn on in order to formulate requirements for interim pipelines.

Documented examples are:

- The setting up of an emergency supply at Maifeld during the conversion of the Olympic stadium in Berlin using DN 250 ductile iron pipes and BLS® restrained push-in joints. Because angular deflections of 3.5° are possible with the BLS® joint, it was possible to install the interim pipeline along the curve of the stadium wall [5].
- The use of a 2,000 m long DN 600 interim pipeline for the South Saxony water supply association. The ductile iron pipes and fittings were used a total of three times in order to allow the renovation of a 6,000 m long section of pipeline [6].
- The installation and reuse of a DN 150 interim pipeline with BLS® restrained push-in joints to maintain the supply of water to the districts of Eimelrod and Hemminghausen in Willingen/Upland by the Upland water supply association [7].

In addition, there are two current practical examples from Leipzig and Berlin. The experiences from these projects can also be used in order to formulate requirements for interim pipelines.



Excavation pit with a DN 800 interim pipeline coming out of it and onto a pipe bridge over the River Mulde

### Interim pipeline between the Canitz waterworks and a pipe bridge

A flood prevention dike runs between the River Mulde and the waterworks at Canitz which has been protected against future floods by the regional reservoir administration by means of sheet pile walls. The communal waterworks of Leipzig took this work as an opportunity to renovate two DN 1000 grey cast iron water transport pipelines running in parallel which supply the city of Leipzig with fresh water from the waterworks at Canitz and

Thallwitz, by pulling in DN 800 ductile iron pipes with BLS® restrained push-in joints.

The two waterworks at Canitz (commissioned in 1912) and Thallwitz (commissioned in 1943) feed their water into the two strings of the 23 km double transport pipeline in the direction of Leipzig. The section of the double transport pipeline to be renovated is located between the pipeline junction at Thallwitz/Canitz in the immediate vicinity of the Canitz waterworks and a pipe bridge over the River Mulde. At this point the pipelines run underneath the flood prevention dike.

The first step was to construct a DN 800 interim pipeline with BLS® push-in joints between the Thallwitz/Canitz junctions and the pipe bridge and put it into operation.

Once the interim pipeline had been commissioned, one of the two DN 1000 pipelines to be renovated was taken out of operation and the DN 800 pipe was pulled in. Then this new pipeline was put into operation and the interim pipeline was decommissioned. The pipes and fittings of the interim were then used again so that the second DN 1000 could be renovated.

When this pipeline was reassembled, the used TYTON® DN 800 sealing rings were replaced with new sealing rings of the same type. The interim pipeline was 208 m long. The section of the Thallwitz pipeline which was pulled in was 178 m, with a total length of 199 m, and the length of the pipe pulled into the Canitz pipeline was 185 m, with a total length of 203 m.



The route of the DN 800 interim pipeline over the dike between the pipe bridge over the River Mulde and the Canitz waterworks



The straight section of the interim pipeline along the construction road to the Canitz waterworks

In all cases, drinking water pressure pipes with restrained BLS® push-in joints, DN 800, wall thickness class K 9, with cement mortar lining to EN 545 and a 400 g/m<sup>2</sup> zinc/aluminium coating plus a blue epoxy finishing layer to EN 545 and DIN 30674 were used. In addition, various fittings in ductile cast iron, nominal size DN 800, were installed.

The joints of the newly constructed pipelines were produced in each case with restrained fittings and valves at the Thallwitz/Canitz junction and on the West side of the pipe bridge.

### Renovation of a wastewater pressure pipeline in Berlin Tegel Forest

An old DN 1000 wastewater pressure pipeline in asbestos cement along the external West and North fence of Berlin Tegel Airport was to be replaced by DN 800 ductile iron pipes to EN 598 with BLS® restrained push-in joints. The new pipeline was to be installed along the same route. This meant that wastewater from the old pressure pipeline had to be routed parallel to it through an interim pipeline constructed above ground. The removal and relaying of the wastewater pressure pipeline was done head-on in a number of installation stages.

In the first stage of the work, an approx. 870 m long section of the interim pipeline was constructed along a forest road. In addition to the steel inserts at the beginning and end of the wastewater pressure pipeline, pipe bridges in steel pipes were used where paths or roads branched off or crossed the route, in order to allow extinguishing vehicles unhindered access to the forest in case of fire.

In the 2<sup>nd</sup> stage of the project, the interim pipeline above ground was first of all dismantled and assembled again in the same way at the new section of pipeline. Because of the tight space conditions in this section of the were, constructing the interim pipeline parallel to the route of the wastewater pressure pipeline was not possible and so the pipeline was laid along an existing forest road. Once complete, the interim pipeline was 1,300 m long.



Interim pipeline along the route of the sewage pressure pipeline to be renovated in the approach path to Berlin Tegel Airport



A bridge of steel pipes to maintain access to the forest

No disruptions in operation occurred throughout the entire construction phase. Also the construction and dismantling of the pipelines was, as usual, uncomplicated. It is planned that the pipes of the interim pipeline will also be used again for securing the receiving water course in the next stage of construction. While the interim pipeline through the Jungfernheide Forest was in operation it was shown that the sentence formulated in EN 805 – “but particular attention needs to be paid to sections of pipeline above ground” – proved to be true, although in a future revision of EN 805 this should be supplemented with a reference to effects due to climate change.

The specific case occurred while the interim pipeline was in operation. In 2017 the Berlin city area experienced the effects of local bad weather events on many occasions. Heavy rain resulted in flooding and squalls took away roofs and uprooted trees.

During the latest storm in October 2017, dozens of trees were uprooted in Jungfernheide Forest and a decades-old oak fell onto the interim pipeline. But this did not cause any interruptions to the operator’s services. Once the oak had been removed from the pipeline then, as expected, it was seen that the pipeline in robust ductile cast iron had withstood the powerful impact of the tree without damage. There were not even any detectable alterations to the surface of the pipe.





Environmentally friendly and space saving construction of the interim pipeline along a forest road



The 6 m long pipes are delivered direct to the construction site by truck



An uprooted oak tree which fell onto the interim pipeline did not result in any operational disruptions



After the oak had been removed there was no sign of damage or even any alteration in the coating

### Requirements for interim pipelines

Based on many years of experience in the planning, construction and dismantling of interim pipelines of ductile cast iron pipes, fittings and valves, the following general requirements can be formulated for interim pipelines constructed above ground:

- the choice of a piping system consisting of pipes, fittings and valves
- a robust, non-flammable, impermeable piping system with a high level of resistance to external influences (e.g. fire and mechanical stresses)
- able to be supplied in a wide range of nominal sizes
- suitable for delivery even under restricted site conditions
- thrust-resistant joints connecting all pipeline elements parts
- the possibility of flexible routing of the pipeline which can be adapted to e.g. structural and/or topographical conditions
- fast, easy and secure assembly, as well as dismantling, even under the worst weather conditions (temperatures in the minus range) without additional expense
- the possibility of using system components again once dismantled without any particular preparation work
- efficiency and environmental compatibility

### Interim pipelines of thrust-resistant cast iron pipe system

For ductile iron pipe systems, pipes, fittings and valves are available in a wide size and pressure range for different liquid media such as fresh water (see EN 545 [8]) or wastewater (see EN 598 [9]). The individual components of the robust, non-flammable and impermeable pipe system are protected against contamination during transport and can be transported on e.g. open trucks and unloaded by excavators.

The 6 m long pipes are delivered direct to the construction site by truck where they can be taken off the back of the low-loader by excavators. The pipes can then simply be stored on timbers, sealed in the socket area. Once the sealing ring is in place, the pipes are assembled using pipe-laying equipment/chain hoists or construction machinery.

Then locking bars or segments are inserted via the openings in the crest of the BLS® socket which are arranged around the circumference in the thrust resistance chamber of the socket in front of the weld bead at the spigot end and then quickly adjusted and the joint is extended slightly.

After this, the pipe joint can be angled horizontally and vertically, depending on its nominal diameter, in order to adapt it to the contours of the route.

In the event that directional changes are necessary which exceed the bending capability of the socket joint, socket fittings with BLS® push-in joints are used. If necessary, it is possible to resort to the diverse range of flanges. When it comes to dismantling the pipeline, the pipe joints are easily released and the locking bars or segments for thrust resistance are pushed up to the opening in the crest of the socket and removed from there. They do not come into contact with the medium in the pipeline and can be handled from outside in front of the socket.

Environmental compatibility is also a decisive criterion for the general framework conditions. A robust cast iron pipe system not only offers security against damage and fire as already mentioned. The fast assembly of an interim pipeline required for a specific time, along with the small amount of space needed for site equipment means minimal disturbance of fauna and flora. Low noise levels (no power generators necessary) and no additional fire prevention regulations to be observed add to the list of arguments, so that even from the point of view of those responsible for woodland and countryside preservation, ductile iron pipe systems should be used.

## Outlook

Interim pipelines are temporary engineering works which enable fluids flowing through the sections of pipeline under renovation to be diverted during the construction phase, so enabling the renovation to be completed without disruption to the service. No general requirements are available for the planning, construction, operation, dismantling and reuse of interim pipelines and this can lead to uncertainty among planners and operators. This is exacerbated by current political development (risks of terrorism), the effects of climate change and changes in the requirements for piping systems (fire regulations).

Against this background, some requirements for interim pipelines have been formulated on the basis of experience and these should be able to be included e.g. in future regulations.

## Authors

### Dipl.-Ing. Uwe Hoffmann

Duktus (Wetzlar) GmbH & Co. KG  
Dessauer Straße 225  
D-06886 Lutherstadt  
Wittenberg  
Phone: +49(0)172 7221174  
E-mail:  
uwe.hoffmann@duktus.com

### Dipl.-Ing. (TU) Lutz Rau

Duktus (Wetzlar) GmbH & Co. KG  
Am Schonungsberg 45  
D-12589 Berlin  
Phone: +49(0)30 64849070  
E-mail: lutz.rau@duktus.com

## Bibliography

- [1] DVGW W 400-2: Technical rules for water distribution equipment Part 2: Construction and testing. September 2004
- [2] EN 805: Water supply – requirements for systems and components outside buildings. Beuth Verlag GmbH, March 2000 edition
- [3] prEN 598: Coated and lined ductile iron pipes, fittings and their joints for sewerage and drainage applications – Requirements and test methods; 2017
- [4] Directive (EU) no. 305/2011: DIRECTIVE 305/2011/EU OF THE EUROPEAN PARLIAMENT AND COUNCIL of 9 March 2011 laying down harmonised conditions for the marketing of construction products and repealing Council Directive 89/106/EEC.
- [5] Oprotkowitz, A.; Rau, L.: Neue Lebensadern für ein Berliner Wahrzeichen „Das Olympiastadion“. Volume 39 Gussrohr-Technik, p. 25–27.
- [6] Gernke, U.; Rink, W.: Interimsleitung DN 600 sichert die Wasserversorgung in Südsachsen. Volume 43 Gussrohrtechnik, p. 60–63.
- [7] Bittermann, I.; Römer, K.-W.: Erneuerung der Verbindungsleitung von der Seerequelle bis zum Hochbehälter Eimelrod in Willingen-Eimelrod. Volume 49 Guss-Rohrsysteme, p. 25–28.
- [8] EN 545: 2010
- [9] EN 598: 2007+A1:2009

## Resistance to root penetration



Root penetration in sewers is known to be an obstacle to flow from the camera inspections regularly carried out. In sewers, this becomes noticeable when blockages occur. In public sewage systems root penetration is one of the most frequent causes of damage. The cause is the oxygen in the soil, which has a major influence on the way that roots spread. Sewers are ventilated via maintenance and inspection openings

## Eco-power from wastewater

Wastewater from the municipality of Zumikon flows down into the wastewater treatment plant of the municipality of Küsnacht on Lake Zurich. The height difference of 180 m is used to produce energy in a small hydropower plant. The 3 km long pressure pipeline runs through a landscape which is difficult to access and geologically challenging and has been installed using the directional drilling technique.

The high tensile forces during installation and the high internal pressures during operation require the use of a robust, flexible and easy-to-handle pipe system. Based on experience, the municipalities of Zumikon and Küsnacht decided on ductile iron pipes with restrained push-in joints, cement mortar coating and a cement mortar lining based on high-alumina cement. In total, 2,918 m of DN 300

and part of the pipeline is filled with air. In this way, because of the gas permeability of pipes and pipe joints, the oxygen can get into the soil. Roots always grow towards the source of oxygen and so find the pipe joint (oxytropism). Ductile iron pipe systems are diffusion-tight and their contact pressures can demonstrably be greater than the pressures exerted by tree roots. As proof, a process has been able to be developed for testing the resistance of push-in joints to root penetration. The results of these extrapolated measurements show that the push-in joints of ductile iron pipe systems have long-term resistance against the penetration of roots.



ductile iron pipes were laid. Of these, two sections with lengths of 748 m and 655 m were laid using the directional drilling technique and the remaining 1515 m by the open trench technique.

## Relocation of a water supply pipeline in the Upper Palatinate



In order to improve the transport links of the district of Cham and to increase traffic safety, Federal highway 85 is being extended and a southern bypass is being constructed for the area of Neubäu am See.

The Kreiswerke Cham water transport pipeline between the pumping station at Neubäu and the Reichenbach elevated tank therefore had to be relocated. This utility company supplies around 40,000 inhabitants of the Old District of Roding and a few neighbouring communities in with drinking water. The project involved installing 348 m of ductile iron pipes in nominal width DN 400. The pipes were supplied with restrained push-in joints and a cement mortar coating. The high operating pressures of 30 bars and the long working life of cast iron pipes with cement mortar coating prompted Kreiswerke Cham to decide in favour of this ductile iron pipe system. Work on the pipeline commenced in mid-July 2016. Not least because of the ease of assembly of the push-in joints, the new section was able to be put into operation as early as the end of August 2016.

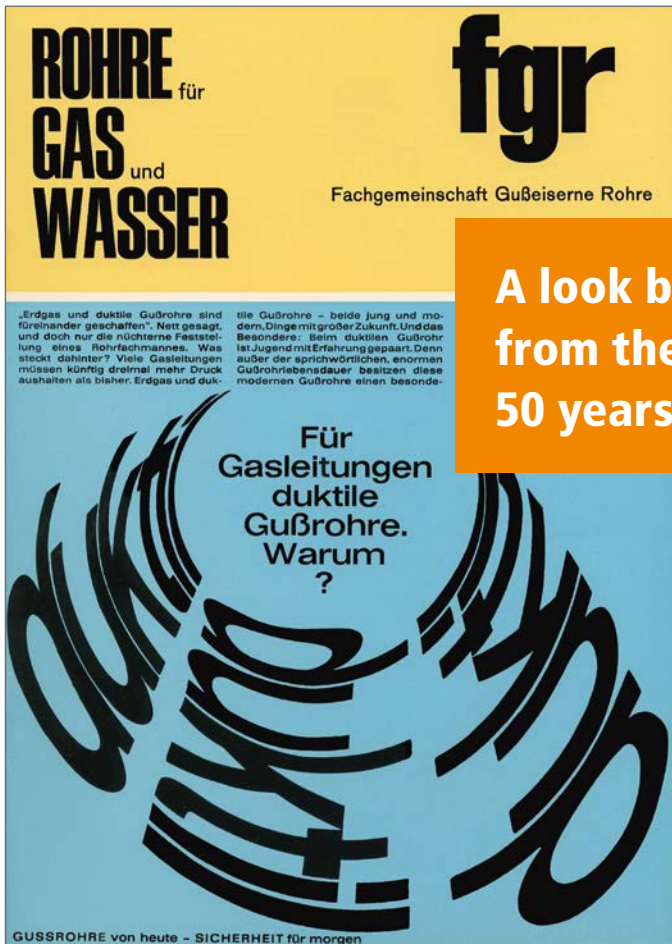

1967

## A look back: from the FGR annual journal of 50 years ago

Ductile iron pipes were being installed more than 50 years ago. This historical article from the archives of EADIPS FGR is an illustration of this. The fundamental mechanical properties were being described right from Issue 1 of the Annual Journal back in 1967. The complete issue of this Journal, along with all the subsequent ones, is available for downloading at [eadips.org](http://eadips.org).

## The properties of ductile iron pipes

by Reinhard SCHAFFLAND

Anyone who wants to familiarise themselves with the properties of ductile iron pipes would do well to first consider the material.

“Ductile cast iron”, also known in other areas of application as “spheroidal graphite cast iron” or “Sphäroguß®”, is one of the latest iron-based cast materials. Its classification in a synoptic table of cast materials is controversial because, although spheroidal graphite cast iron represents a further development of cast iron with lamellar graphite, its properties justify it having its own place in the system. Figure 1 shows the classification of spheroidal graphite cast iron as a sub-group of cast iron.

As with the other malleable cast materials, spheroidal graphite cast iron is also **standardised according to tensile strength, yield strength and elongation**. It differs from cast iron with lamellar graphite because of its **high elongation** and its **pronounced yield strength** in particular.

The structure of cast iron with lamellar graphite is shown in Figure 2. Up to 4 % by weight of free carbon in the form of differently shaped platelets or sponge-like structures is embedded in the matrix. These graphite inclusions, which can be seen as lamellae in the picture, do not have a great deal of inherent strength and they weaken the supporting matrix by their interruptive notching effect.

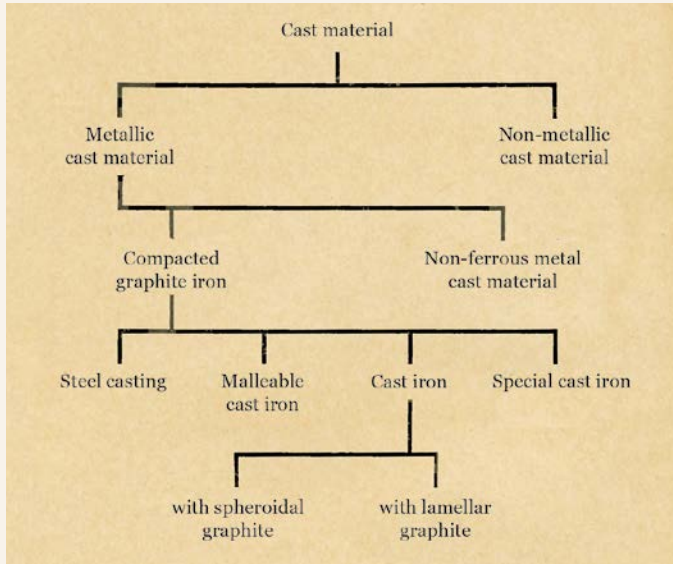

Figure 1

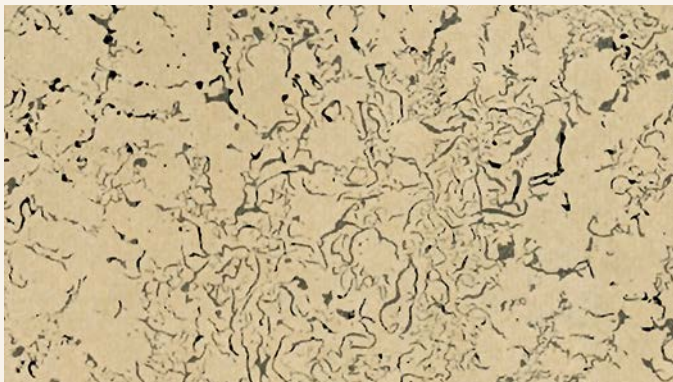

Figure 2

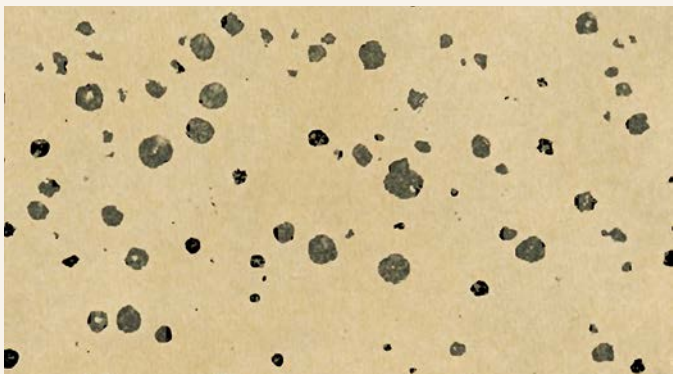

Figure 3

This results in a strength of 20–25 kp/mm<sup>2</sup>. It amounts to about 50 % of the strength of the matrix, while the proportion by volume of graphite only amounts to 12 %. As with the absence of plastic elongation, this can only be due to the shape of the graphite.

A reduction of the proportion of free graphite really had to look like a good way of improving the properties. However, this process is only possible to a limited extent, as otherwise this would result in the white solidification of the material with greater hardness and brittleness and, in the extreme case, in an entirely different kind of melt and casting conditions. Therefore, it seems that there is only one way of effecting a change in the form of crystallisation of the graphite.

With ductile cast iron this is achieved because the graphite is able to be brought to the most favourable form, i.e. that of a sphere. As was to be expected, the technological properties of the matrix were achieved by this means. Figure 3 shows an image of ductile cast iron. One can clearly see the **graphite spheres embedded in the matrix**. These do not have any notching effect, but merely divert the lines of force slightly under stress.

Although it has been known since the beginning of the century that graphite can also crystallise in spherical form, it was not until 1947 that this material could unerringly be produced on a large industrial scale. Today this is generally done by bringing a molten mass which is low in phosphorous, sulphur and so-called interfering elements to a relatively high temperature and treating it with magnesium or magnesium alloys. The vapour pressure of the magnesium, which is already at one atmosphere at around 1,100°C, needs to be taken into account here. Cerium, for example, works in a similar way to magnesium and this is also used, rarely on its own, but more often as an additive.

After the treatment with magnesium, we have a smelt which leads to the formation of a spheroidal graphite cast iron. After a long settling time or after further re-founding, graphite lamellae form again.

In many cases spheroidal graphite cast iron is used in its as-cast state. However, it can be further improved by heat treatment and then used accordingly for its intended purpose.

The **higher strength and plastic workability of spheroidal graphite cast iron** as compared with grey cast iron offers some major advantages for the consumer. As its castability is good, parts with complicated designs and greater differences in wall thickness can be cast. **Spheroidal graphite cast iron responds well to machining and it outperforms most materials of equal hardness as regards permissible cutting speed and tool life. It has a good damping capacity.** It proves to be tough with respect to impact loads, which is to be expected given its strength values.

The resistance of spheroidal graphite cast iron to corrosive attack is, depending on the chemical composition, comparable to that of lamellar graphite cast iron.

Once spheroidal graphite cast iron could be produced on a large industrial scale, it quickly found its way into a whole range of application areas, such as general mechanical engineering and the automobile industry.

It is not surprising that the cast iron pipe industry too would soon catch on to spheroidal graphite cast iron and it saw a range of possibilities for increasing the reliability of cast iron pipes still further, opening up new areas of application or reducing wall thicknesses and weight.

It is interesting that pipes in ductile cast iron – this is the name that has been given to the pipe material – was not first used for smaller, less challenging trial pipelines. The first pipeline produced in the Federal Republic and put into operation in Spring 1957 in fact was over 100 km long and, predominantly with a nominal width of 200, is operated with a gas pressure which, in a weekly cycle, rises to 25 kp/cm<sup>2</sup>. It had already undergone acceptance by TÜV on the basis of directives which, in principle, still apply today.

As technical delivery conditions are addressed in another article in Volume 1, here we will only examine one important point, which is taking samples. With spheroidal graphite cast iron in accordance with DIN 1693, the bars for testing tensile strength are

taken from separately cast U or Y specimens. These specimens must be poured from the same ladle as the pieces to be assessed. This produces the same casting and solidification conditions so that the specimens allow reliable and reproducible information to be provided on the material properties.

This process can indeed be applied in a similar way for ductile cast iron fittings, but not for pipes as these are subject to completely different casting and cooling conditions as compared with sand-cast specimens. Also, the general heat treatment of pipes and the associated specimens would be difficult to carry out. Therefore, bars are taken from the spigot ends of pipes for tensile testing purposes; at the same time this offers a certain guarantee that the values found will be found on the end product, i.e. the pipe. Because of the smaller wall thickness, the diameter of the bars selected for tensile testing must in some cases be thinner than stipulated in DIN 50 125. Scatter here can result in poorer values. However, this fact is taken into account in DIN 28 600.

After the successful laying of the high-pressure gas pipeline mentioned above – which by the way is still working without problem today – the ductile iron pipe, which by now was being produced by all German and many foreign cast iron pipe manufacturers, was able to steadily increase its share of the market. The fact that its properties had first been carefully tested goes without saying. In the text which follows we shall pick out a few typical examples from the whole range of tests and trials.

In the absence of proven test processes suitable for the pipe material, at the time when the pipes for the pipeline mentioned above were being produced, it was still ring bending stress resistance that was being tested, as it was with grey cast iron pipes. 80 kp/mm<sup>2</sup> was used as the minimum value here – a value which is twice as high as that established in DIN 28 500 for lamellar graphite cast iron. However, many more than 1,000 samples showed that the method produced less meaningful results. They never went below 80 kp/mm<sup>2</sup>; by contrast, and especially with relatively thin-walled rings, load resistance values of more than

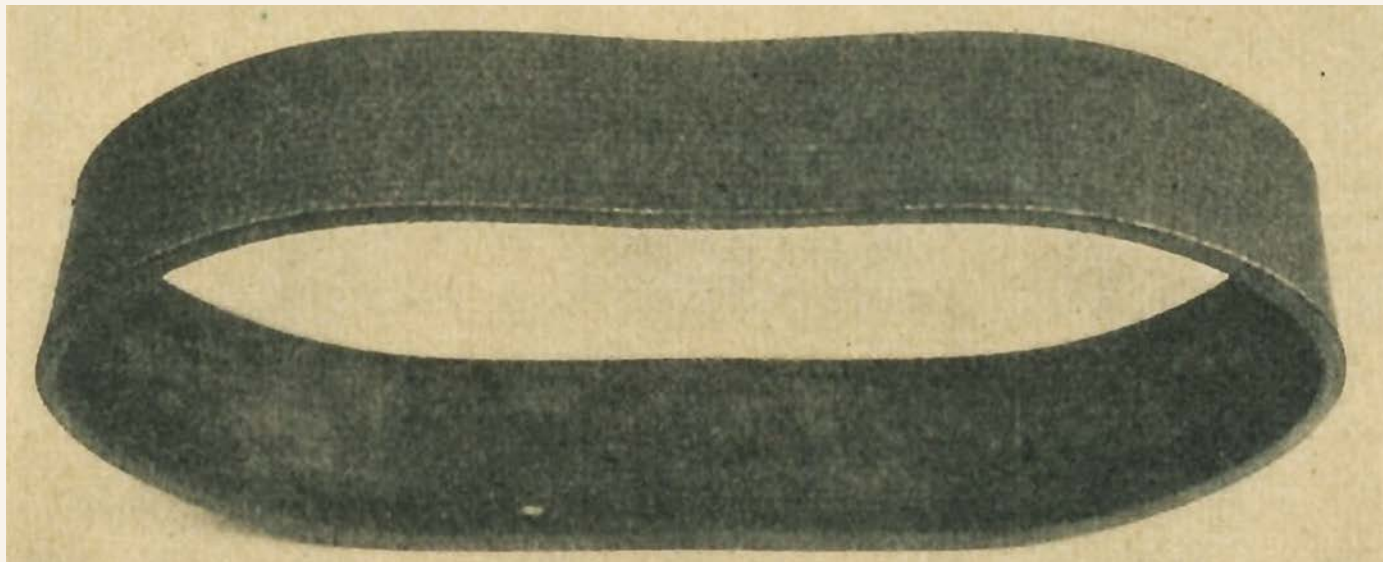

Figure 4

500 k<sub>p</sub>/mm<sup>2</sup> were occurring. Figure 4 shows a deformed ring of this kind. It turned out that the rings were stretching, i.e. that the ring bending stress had become a proper tensile test with a preloaded flat bar.

Similar deformations can be produced by the ring stiffness test, i.e. by a bending load which corresponds to the load on the crown of the pipe in the pipe trench.

Accordingly, fractures due to loads on the pipe crown in installed pipelines are practically excluded. Tensions which exceed yield strength limits can be relieved by plastic deformation. Even with bending stress loads, ductile iron pipes are extremely resistant.

Bending tests taken to rupture point produced bending resistance results of 60 to 90 k<sub>p</sub>/mm<sup>2</sup>. However, such tests can only be carried out accurately with small nominal widths as, with larger sizes, the distance between supports which is limited by the length of the piece is not sufficient to keep the middle load low enough that no deformation occurs due to stress on the crown.

In most pipe standards, internal pressure plays a decisive role in the calculation of pipe wall thicknesses. Minimum wall thicknesses are assigned to the individual pressure stages.

The following burst tests are described in an article by Walter and Stumpf:

#### ***Burst test***

*“The pipe string to undergo this test consisted of four ferritic centrifugally cast pipes in ductile cast iron NW 150 with API threaded sockets. The minimum wall thickness was 7.6 mm. Because the string, sealed at its ends with caps, was not provided with thrust blocks, axial forces were able to take effect during the water pressure test. While the pressure was being applied, all leaded threaded connections and pipes were absolutely tight up to the bursting pressure of 360 atm.*

*At 360 atm, one pipe ruptured as a result of the effective circumferential force lengthways and was then torn apart by the axial force.*

*During another burst test, a similar pipe string was taken to rupture point at 305 atm. There was a longitudinal crack with ramifications at its ends.*

*In both cases the rupture points showed characteristics of a steel-like expansion. There were no shell fragments as are found when normal grey cast iron pipes burst. Here again the steel-like behaviour of centrifugally cast pipes in ductile cast iron was observed. For a water pipeline operated at 100 atm, the bursting at 360 and 305 atm gives a 3.5x and 3x safety factor.*

*In the context of these tests, a water ball cup NW 200 and an EA fitting NW 200/80 (flange socket NW 200 with flange connector NW 80) in ferritic ductile cast iron were also to be taken to bursting point. The water ball cup ruptured at 235 atm. Because of a larger radius of curvature at the transition between the ball and the socket, even here the bursting pressure was able to increase to 300 atm. The EA fitting NW 200/80, which is to be used as a valve connection piece, showed no lack of tightness in the material at all up to 400 atm, nor any deteriorations at the connections. The burst test had to be interrupted because the pump used for pressurisation could not deliver a water pressure higher than 400 atm.*

It should also be mentioned that the bursting pressures stated above give ring tensile strength figures of 49.7 to 42.2 kp/mm<sup>2</sup>. These values relate to results from pipes taken from production at random. According to DIN 28 600 (in preparation), considerably lower strength values are set for the calculation. In reference cited, there is also a description of the bursting of two fittings. It is interesting here that the water ball cup which burst open at 235 atm only had wall thicknesses of around 16 mm in its spherical part with a diameter of approximately 600 mm, from which a bursting resistance of 44 kp/mm<sup>2</sup> is calculated. Apart from the tests mentioned so far, which served to explain the behaviour of ductile iron pipes with respect to the main types of stresses on buried pipes, a large range of additional tests have been performed, of which only a few need to be mentioned here.

Under heavy road traffic conditions, pipelines can be subjected to reverse bending stresses. In such cases the flexible pipe joint most widely used and which is installed every 6 m at least has a favourable effect and no bending forces are transmitted. By contrast, the effects which bending vibrations have in the least favourable cases, namely when a rigid joint is used, are again described by Walter and Stumpf:

#### **Leak tests**

*“Leak tests were first carried out on a centrifugally cast ductile cast iron pipe string with the API threaded socket joint, which was previously to have been subjected to very strong mechanical stresses. Four ferritic annealed centrifugally cast pipes in ductile cast iron NW 150 (wall thickness around 7.5 mm) were screwed together in a strong and sealed at both ends with caps. The pressureless string which was first to undergo an endurance test was*

*hung with one end in a belt while the other one before the last socket was freely laid on a squared timber. The belt cord ran over a roller guide to the cam of a drive wheel which caused it to move 80 mm vertically up and down 85 times a minute. In this way the string was subjected to oscillation. While one end of the string was lifted with the belt, the other was pitched hard onto the ground each time. The amplitudes were up to 200 mm.*

*After 250,000 oscillations in each case, a water pressure test at 40 atm and an air pressure test at around 27 atm were carried out.*

*The test was broken off after 1,020,000 oscillations as, in practical operation, such major and frequent stresses are in no case to be expected. As with the intermediary pressure tests, even with the subsequent water pressure test at 40 atm, all leaded API threaded joints proved to be completely tight. A 13-day air pressure test following on from this at 27.25 atm showed the same result after proper and careful soaping of the joints.*

***This test showed that, in contrast to grey cast iron pipes, ferritic centrifugally cast pipes in ductile cast iron can also be laid underground where shock and vibration generating stress from outside has to be taken into account, for example when they are laid beneath streets.***

*After the endurance test, the NW 150 string was extended to 12 pipes, sealed at both ends with caps and subjected to a deflection test. To this end, the pressureless string was suspended at three points so that it could sag elastically under its own weight. The deflection of the individual pipes here, with reference to their chord between socket outlet and spigot end, was up to 70 mm, while the deviations with respect to the suspension points were measured at 1.1; 0.6 and 1.5 m. It can be seen how elastic ferritic centrifugally cast pipes in ductile cast iron are with the rigid API threaded socket joint.*

*In addition, the string was powerfully rocked by a worker with his foot many times.*

*A three-day water pressure test at 40 atm was then performed on the string after it was taken down. Despite the stresses which they had undergone, all sockets proved to be completely tight. During a number of air pressure tests at 25 atm, no leaks could be detected on the pipe string even after careful soaping.*



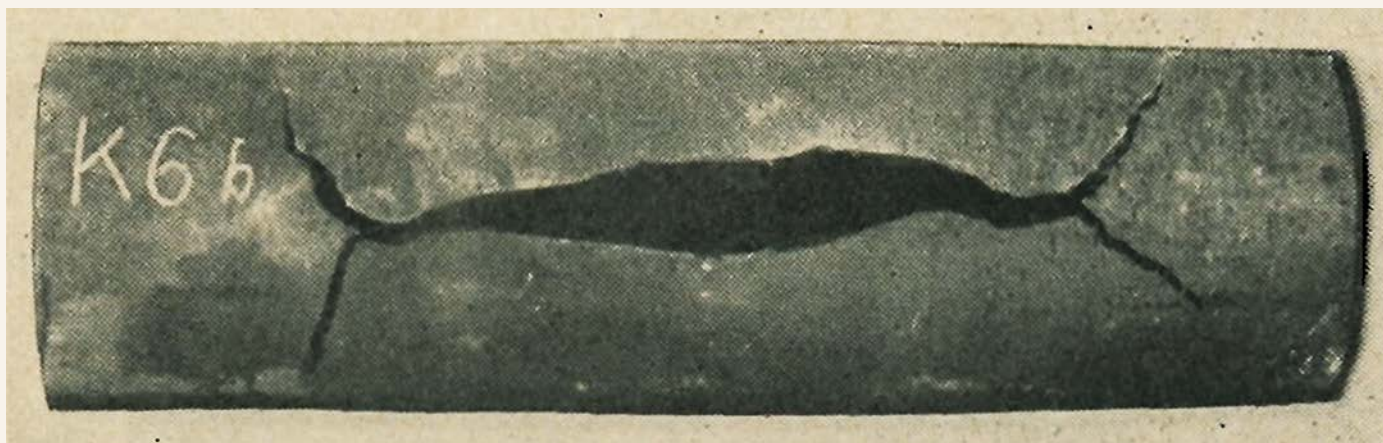

Figure 5

*The way in which the ferritic centrifugally cast pipe in ductile cast iron behaves under excessive stress from internal pressure is shown by a burst test which has been carried out."*

In water pipeline networks there are often pressure surges which can amount to many times the operating pressure. In order to test their effect on ductile cast iron pressure pipes, explosion tests have been carried out. Explosions of this kind have already been carried out previously on valves in spheroidal graphite cast iron in which it was shown that the rupture behaviour showed a tenacious character in each case.

With ductile cast iron pipes, it turned out that, with the explosions, cracks form which, as Figure 5 shows, do not differ from those in static burst tests.

It was thus able to be demonstrated that the behaviour of ductile cast iron pipes is entirely independent of the loading velocity, and especially that the circumferential elongation measured after the explosion matched that of the burst tests. It should also be mentioned here that the load strength with pipe materials without plastic expansion was lower by more than a factor of ten, but with the best deformable materials there is scarcely any need to select a higher one. Explosions of this kind carried out on flexible pipe joints in fact resulted in the superiority of these connection elements as compared with the smooth pipe.

The list of special tests on ductile pipes and pipe strings goes on. Manufacturers, users and test institutes have carried out a host of tests, most of which produced generally accepted results but which were often tailored to specific areas of application. We will

simply mention the report by Prof. Dr.-Ing. habil. K. Wellinger, which forms the basis for the pipe calculation which can be found in DIN 28 600 which is currently in preparation.

### Summary

Ductile cast iron is presented on the basis of some tables and pictures. It is shown that it has a close relationship, and one which is interesting from a corrosion point of view, with lamellar graphite grey cast iron with its properties in the middle range of iron-based cast materials. Tests and practical experience with pipes and pipelines have proved that centrifuged pressure pipes in ductile cast iron are capable of resisting the highest loads encountered in practical operation and have sufficient safety reserves.

### Bibliography

- [1] W. Walter and W. Stumpf  
"Geschleuderte Druckrohre aus duktilem Gußeisen",  
GWF 43, 1960,  
p. 1097-1108

## Fürst-Pückler cast iron edition

The production of architectural cast iron at the smelting location of Keula, the current day Krauschwitz, can be traced back to the beginning of the 19th century. The most famous bridge at that time was the Fuchsienbrücke in the Blaue Garten, which Fürst (Prince) Hermann von Pückler-Muskau had made in his ironworks in Keula. The principal design element of this bridge, the pot of fuchsias, is part of the Fürst-Pückler Gussedition® of castings.



Also part of this special edition is a fence module designed in the style of a historic set of railings in the Pückler Park in Branitz.

The street lights, formerly known by the term candelabra, are particularly valuable. At the right location, even today they impart the atmosphere of past centuries. They appeared in the Keula Ironworks catalogue of products as early as 1880. In addition, there is a selection of bollards. The collection is rounded off with three styles of park benches based on traditional designs. This includes a model of the Pückler bench from his park in Bad Muskau. The "Keula" model was and probably still is the most widely recognised park and garden bench in Lausitz. Because of their durability there are surely many generations who have sat on these without knowing about their historic origin.

[fuerst-pueckler-gussedition.com](http://fuerst-pueckler-gussedition.com)

## Optimum protection with ETEC enamel



Individual soil and water qualities also place high requirements on surface protection. As ever, corrosion is the principal cause of pipeline damage. In order to cope with every situation, an effective and lasting surface protection is needed. Düker offers a number of products with linings and coatings individually adapted to each type of application. Enamel in particular is suitable for almost any task and also for quite special areas of application thanks to

modern analytics and modified process technology. Unlike coatings, this special glass undergoes a chemical bonding with the substrate during enamelling. This makes enamel exceptional in its combination of corrosion resistance, impact resistance and resistance to incrustation and acids, to the build-up of bacteria and to wear and abrasion.

## New ERHARD TALIS logistics centre



27 April 2017 saw the inauguration of the ERHARD TALIS Logistics Centre in Herbrechtingen near Heidenheim. To be able to serve its clients according to the needs of the market, there are 4,000 pallet bays with all standard products available with immediate effect. In total the logistics park provides more than 80,000 m<sup>2</sup> of storage capacity and offers further potential for expansion for ERHARD TALIS. Meaning that there is enough room in the future for flexible changes, always accompanied by a modern logistics performance and infrastructure. The future use of scanner-supported storage systems not only means paperless and error-free order picking but it also opens up a new dimension of availability in our markets (ship on demand).

## TRM piling systems awarded the EPD



After long and intensive preparation, a short while ago TRM Pfahl-systeme received the Environmental Product Declaration (EPD). This is a declaration which summarises environment-related information about similar products in terms of environment and sustainability, especially CO<sub>2</sub> consumption, so that they can be compared. The compilation of this declaration is based on data and figures from the manufacturer's production. In practical terms, this declaration is used as a benchmark for sustainable construction methods, so that various bids can be compared with reference to their ecological quality.



## Frischhut invests in new production plant

The Frischhut foundry has invested three million euros on making their production more flexible and on achieving energy savings so that customer requirements for small batch sizes and just-in-time deliveries of castings can be met more effectively. With around 90 employees, Frischhut produces around 5,500 tonnes of cast iron a year in batch sizes of between three and hundreds. In the process of this investment the furnace technology has been changed, the charging system and composition hall has been replaced, modern energy management has been introduced and efficient casting line extraction has been installed. In order to meet its clients' requirements for ready-to-install castings,

a state-of-the-art grinding centre has also been built. The new equipment allows a remarkable flexibility of production with better quality. In addition to the gains made in production flexibility and process reliability, Frischhut is also achieving considerable energy savings and hence the associated cost reductions. A significant measure in the improvement of energy efficiency was the installation of an innovative energy management system, which continuously records the power consumption across the whole business. With the renewal of production equipment and the improvements in processes, around 20 % of energy can be saved in the plant as a whole.

## Revitalisation of the Friedrich power station in St. Michael

On the occasion of its 30<sup>th</sup> anniversary, at the Friedrich small hydropower plant in St. Michael im Lungau, a revitalisation has been taking place. The extensive renovation work started back in June 2017 and was completed by September 2017. In the course of the rejuvenation of this plant, a 1,500 m length of under-dimensioned DN 150 pipelines were replaced with new TRM cast iron pipes with restrained joints in

nominal size DN 250. In this way the output was increased from 53 kW to the approved 100 kW thus making an annual power production of 650,000 MW/h possible. Also, the snow-making pipeline which runs parallel to this was integrated at both ends and the entire power plant control, along with the turbine, was replaced.



Matthias Müller

# Loose-flanged butterfly valves for a perfect fit

The butterfly valve is the second most frequently installed type of valve. As a closure device, the so-called valve disc sits in the cross-section of the pipeline. Butterfly valves are usually installed in the network via flange connections. A particular type is the loose-flanged butterfly valve, such as the ERHARD ROCO wave butterfly valve.

These butterfly valves have a fixed flange on one side and a loose flange on the other side. They are 3 mm shorter than the standard lengths of butterfly valves according to EN 558 [1] with two fixed flanges. The loose flanges are movable within a certain application range (-1 mm to +5 mm), beyond that they are firmly connected with the valve housing.

The standard length of the loose flange is in the negative tolerance direction. Because of the elimination of the flange seal on the loose flange side, there is additional play which is needed when replacing

conventional valves if the distance between the adjacent flanged pipes cannot be altered.

## Assembling the ROCO wave loose-flanged butterfly valve

The diagram on the right below illustrates the assembly sequence. The seal is integrated into the loose flange. Before assembly, the loose flange with integrated flange seal is put into the end position. As the housing is produced in negative tolerance, there is a gap between the butterfly valve and the pipeline, making easy insertion into the open gap possible.

After assembly, the loose flange with integrated seal is drawn into the flange of the pipeline and the connection is screwed down. This bridges the gap between the valve and the pipeline from the loose flange. The integrated flange seal securely closes against the pipeline and the housing of the valve. With its positive locking retaining

elements, the joint between the loose flange and the valve is also designed to be tension resistant.

## Areas of application for loose-flanged butterfly valves

On the one hand, loose-flanged butterfly valves are used in new equipment projects to that the time-consuming and expensive installation of adaptors and extensions can be avoided. On the other hand, loose-flanged valves can ideally be used as replacement valves when renovating equipment and supply networks. In the case where they are used in new construction projects, approximately 20 % of savings can be made in material costs as compared with the standard construction method using adaptor and extension pieces. Also added to this is the advantage that installation times and the associated personnel costs can be reduced to around one third.

	Overall length	
	Standard lengths to EN 558 [1]	Loose flange adjustment range min/max
DN 150	210 + -2	209/215
DN 200	230 + -2	229/235
DN 250	250 + -2	249/255
DN 300	270 + -3	269/275
DN 350	290 + -3	289/395
DN 400	310 + -3	309/315
DN 500	350 + -3	349/355

Adjustment range of loose-flanged butterfly valves in the DN 150 to DN 500 range as compared with the standard lengths of butterfly valves to EN 558 [1]



Assembly of the ERHARD ROCO wave loose-flanged butterfly valve: (left to right) sealing ring as flange seal (EPDM), retaining ring (stainless chrome steel 1.4301), loose flange (EKB epoxy coated), O-ring, fixed flange

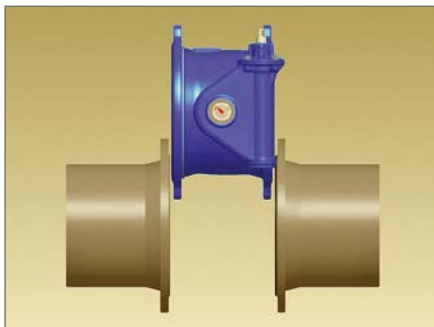

### ROCO wave butterfly valve for easier installation

Because flange seals become compressed, it is often only possible to remove the old valve by brute force or with special tools. The installation of an identical valve of the same length and the usual flange seals thus becomes almost impossible.

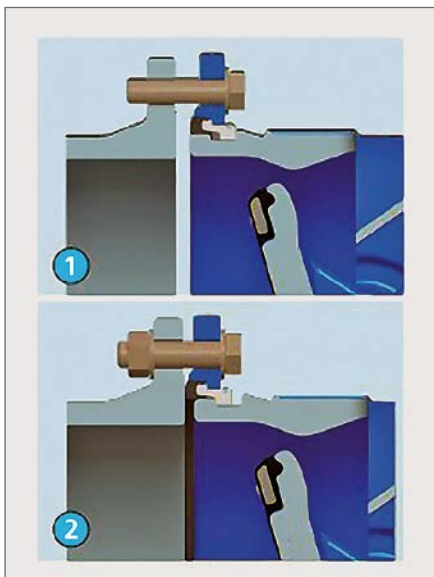

With the loose flange of a ROCO wave butterfly valve, installation can be considerably easier. First of all the valve is assembled with the fixed flange on one side of the existing pipeline. In this way the valve is also secured against twisting. Then the loose flange can be positioned and screwed onto the other side of the pipeline. With the fixed flange on one side, installation in vertical positions is also possible.

PN 10 nominal pressure range. The housing of the butterfly valve is always enamelled and coated on the outside with epoxy powder (EKB). The flow-optimised valve disc of the ROCO wave also has an epoxy coating (EKB). The ERHARD ROCO wave loose-flanged butterfly valve with the standard slider crank mechanism SKG is suitable for installation both in industrial plant and underground.

### ROCO wave butterfly valve for new equipment and renovations

ROCO wave loose-flanged butterfly valves are 3 mm shorter than the standard lengths for butterfly valves in accordance with EN 558 [1] with two fixed flanges. The length of the loose-flanged valve is in the negative tolerance direction and the elimination of the flange seal on the loose flange side means that there is additional play. It can be used for installing new systems and for renovating existing ones. When used in new systems it can be economical in terms of both material and working time. And when valves in existing systems are being replaced, these valves make installation considerably easier.

With minus-tolerance production and adjustable flange the ERHARD ROCO wave loose-flanged butterfly valve fits perfectly into the gap of a shut-off valve with a length to EN 558 [1], R 14

### Coatings and drive

The ROCO wave loose-flanged butterfly valve is supplied in the nominal width range DN 150 to DN 400 in the nominal pressure ranges PN 10 to PN 16. The DN 500 butterfly valve is available in the

### Bibliography

[1] EN 558-1: 2017-05

### Author

**Matthias Müller**  
Productmanager

ERHARD GmbH & Co. KG  
Meeboldstraße 22  
D-89522 Heidenheim  
Phone: +49(0)7321 320-217  
E-mail:  
mmueller@talys-group.com



Easier assembly using the single-side loose flange



Loose-flanged ROCO wave installed vertically or as an element in a pipeline system



Werner Volkart

## The water supply for the Swiss district of Sarnen is a sustainable investment

Sarnen is the capital of the Canton of Obwalden in Switzerland. It lies on the North-East bank of the Sarnersee lake. The water supply for Sarnen is provided by the combined water supply associations of the former village community of Sarnen and the districts of Schwendi, Ramersberg and Kägiswil.

### Popular vote to fund the extension of the water supply network

The present system supplies around 9,000 residents with drinking water as well as water for industrial and extinguishing purposes. It covers a large area involving a height difference of approximately 1,000 m. This means that, hydraulically speaking, the water supply network is very complex. In order to continue to secure supply to the people in the district of Sarnen in the future, on 7 March 2010 the local population approved the project for extending the water supply network and

for the construction of a DN 200 turbine pipeline. After generating power for the community, the water from the turbine pipeline will be fed into the communal drinking water network. The project, expected to take 10 years, has been financed by a framework credit amounting to 20.75 million Swiss francs.

### Ductile iron pipes flown in by helicopter

To date a total of around 7,800 m of ductile iron pipes from Duktus/Hagenbucher with cement mortar coating and BLS® restrained push-in joints in various nominal sizes have been installed. In areas of inaccessible terrain, the pipes have been transported from their storage place to the installation site by helicopter. Added to this was the construction of the new water reservoir and waterworks at Talen, where high-pressure valves in nominal pressure stage PN 64 (64 bar) have been installed by Erhard/Hagenbucher.

### Installation of cast iron pipes in inaccessible terrain

Sarnen decided in favour of a ductile iron pipe system consisting of pipes with cement mortar coating and BLS® restrained push-in joints as well as ductile cast iron fittings and valves with restrained joints because this system is particularly good when it comes to constructing a pipeline in difficult, stony ground with the operating pressures to be expected.

The choice of ductile iron pipes with cement mortar coating allows the material excavated from the pipe trenches to be used again for backfilling. The BLS® restrained push-in joints can be easily assembled in steep and rough terrain and there is no necessity for any additional concrete thrust blocks.



The store of ductile iron pipes ready for transport and installation by helicopter



DN 200 iron pipes were flown in where the terrain was steep



Installation of the ductile turbine and supply pipelines in the same trench



Ductile iron pipes flown in by helicopter, ready for assembly from bottom to top

The short assembly times and the fact that the excavation material could be reused prove that the ductile iron pipe system selected here is particularly economical.

### Already delivered to the water supply areas:

- Hintergraben: 1,420 m DN 100 ductile iron pipes and 1,980 m DN 125 ductile iron pipes, both including fittings
- Gerenstock: 2,180 m DN 200 ductile iron pipes, including fittings
- Brunnmatt-Gubermatt: 1,280 m DN 100 ductile iron pipes, including fittings
- Stalden-Buechetsmatt: 1,020 m DN 250 ductile iron pipes, including fittings
- Talen reservoir: various high-pressure valves up to 64 bars from Erhard GmbH & Co. KG

By 2022 around 7,500 m of ductile iron pipes from Duktus/Hagenbucher will have been installed in the context of this project.



Connection of the turbine pipeline to the turbine with a dirt trap and a ball valve, each in PN 64

#### Author

**Werner Volkart**

Rohre und Armaturen  
 TMH Hagenbucher AG  
 CH-8050 Zürich  
 E-mail:  
 w.volkart@hagenbucher.ch

#### Developer:

Wasserversorgung Sarnen

#### Engineering:

ewp bucher dillier AG Sarnen

#### Pipeline construction:

P. Wallimann San.-Anlagen  
 Sarnen, Roland Schild GmbH  
 Brienzwiler

Roland Gruber

## Cast iron pipes withstand the onslaught of high water

When the right kind of pipe joint becomes a question of economic survival

The devastating storms in July 2017 caused dramatic damage to a number of small hydropower plants in the Upper Styria region of Austria. Above all it was the power station pipelines which were affected by the flooding which followed the heavy rainfall. Damage costs ran into tens of millions. One thing was particularly striking from a subsequent analysis: **ductile cast iron pressure pipelines installed with restrained and bendable socket joints withstood the deformations and loads which they were subjected to.** Sections of non-restrained pipe joints were torn apart by the forces of nature or individual parts of them were broken up and had to be replaced at great expense.



The storm caused the destruction of numerous pressure pipelines in the Sölk valley in Austria. Conventional, non-restrained push-in joints did not withstand the extreme loads.

### Massive damage to pipelines in the Sölk valley

Storm Petra will stay in the memory of the inhabitants of the Sölk valley in Austria for a long time. In the night of 17-18 July 2017 up to 100 mm per square metre of rain fell, classifying the storm as a so-called 100-year flood event. In the Sölk valley, the storm caused the destruction of numerous pressure pipelines. Conventional, i.e. non-restrained push-in joints did not withstand the extreme loads they were exposed to. The effects were devastating. There were hundreds of mudslides and in some cases, landslides were severe enough to expose the bedrock. It was close to a miracle that no people and no livestock were injured.

Also, among the main victims of the catastrophic weather conditions were the operators of the small hydropower plants in this region. Rudi Stelzl, from the Tyrol's traditional pipe manufacturing company TRM, expressly referred to two plants which remained undamaged in this context.

*"In the Sölk valley, all of the power stations on the Liezen and on the Murtal side were damaged by the storm. Apart from two exceptions. These were firstly a small hydropower plant on the Liezen side and then another one which I know on the Murtal side."*

The difference between these two hydropower plants and the other ones is that both are equipped with a **pressure pipeline in ductile cast iron with positive locking restrained push-in joints.** Even in places where entire hillsides fell away, the restrained pipelines remained, albeit uncovered and exposed, but still fully intact. The difference was really obvious.

With positive locking restrained push-in joints, the positive locking between the spigot end and the socket is achieved by means of locking segments.



They are supported on one side on a weld bead at the spigot end and on the other side in the retaining chamber of the socket. This produces a **positive locking transmission of forces between the spigot end of one pipe and the socket of the next pipe** or next fitting.

Depending on the nominal size of the pipeline, there are between 2 and 14 locks which are easy to assemble. They are inserted via an opening in the socket and arranged around the circumference of the pipe. If a pipe has been cut, a clamping ring can be used. Pipes with VRS®-T joints are available in 5 m and 6 m lengths. The advantage of these joints lies above all in the fact that they can withstand a very high operating pressure and transmit enormous tensile forces. The restrained system with DN 900 pipes is designed for tensile loads of up to 1,845 kN. The joints are flexible and, depending on nominal size, allow angular deflections of between 1.5° (DN 1000) and 5° (DN 100).

### Restrained joints in iron pipes hold firm

This is also described as very impressive by qualified engineer Peter Neumann. He is the planning engineer responsible for the renovation of the two Upper Styrian power stations, Schöder 1 and Schöder 2.

*“With the Schöder 1 power station there were two sections where up to ten pipes at a time were torn away from the pipeline. They were later found in the stream bed and were no longer usable. They had obviously been simply pulled apart by the force of the torrent. But there were also areas of the pipeline, originally buried but now washed clear of the ground, which were still completely intact.”*

Also, the section of the pipeline for the Schöder 1 power station which runs underground through the village showed no damage at all. Peter Neumann further mentioned those pipe bridges where the thrust blocks had withstood the flooding. Here again, one thing was quite clear: **the sections of pipeline which were fitted with restrained joints survived the storm undamaged.** The others did not.

### Repair work on the pressure pipelines

Once the damage had been cleared up and itemised, there was the repair work to be done, which proved to be very challenging, especially with the defective pressure pipelines.

Peter Neumann: *“In some cases it was really very difficult to get out all the mud dirt and debris which had got into the pipeline. Basically, we went about the task by starting at the water catchment end and then flushing the pipeline in sections from top to bottom. However, to do that it was first necessary to completely free the sand trap of all gravel and fine so that it could not be flushed back into the pipeline again. In the area just before the powerhouse of the Schöder 2 power station we carried out the flushing from the bottom upwards over a length of around 100 m so that no more sediment could reach the machines. Even that was successful in the end.”*

While the new pipes were being laid in the sections affected, an additional manhole was also integrated. *“Directly before the powerhouse of the Schöder 1 power station there is a trough in which a great deal of material was*



A power station pipeline installed next to a stream bed; once exposed by the scouring water, the non-restrained socket joints were pulled apart.

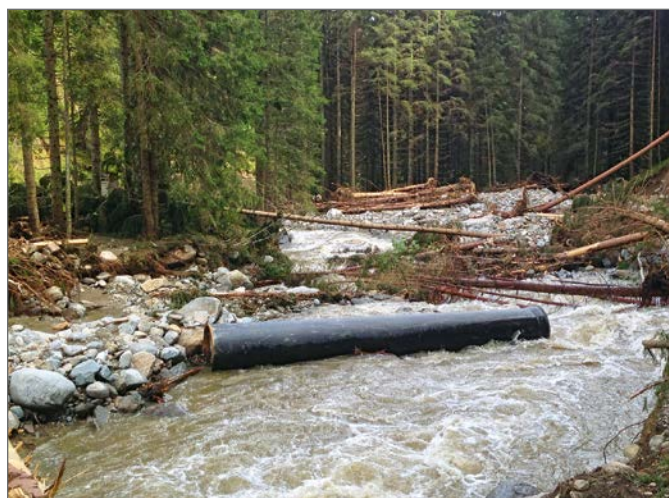

A lone section of power station pipeline which was washed away in the flood. This pipe could not be reused.

deposited. A manhole with integrated flushing pipeline has now been installed there”, said the planning engineer, who pointed out that meanwhile, **all sections now have a VRS®-T joint, in other words the patented positive locking restrained joint** from the TRM company.

*“As we have seen with these power stations, laying pipes with restrained joints makes absolute sense in Alpine areas. An alternative to this would be laying the pressure pipeline considerably deeper. One reason against this, of course, is that this also involves additional costs. And sometimes the geological circumstances simply do not allow this.”*

As an additional safeguard, large revetments have now been cast in concrete. This means that for the next storm, which hopefully will be a long time coming, the power stations are best equipped to meet it.

### The damage insurers take stock

Naturally, in cases like this, the subject of insurance is an important one. The insurance industry already offers solutions specific

to hydropower and, with all probability, will react to the outcomes of the storm damage in Upper Styria and draw their conclusions accordingly. The material damage incurred was enormous. In an initial damage estimate, State Governor Hermann Schützenhöfer reckoned the total sum to be more than 100 million euros.

For experienced expert Anton Alt from the Voitsberg insurance bureau Alt & Walch, this is a thoroughly alarming development: *„Natural catastrophes like the one in the Sölk valley this Summer seem to be increasing, both in frequency and in intensity. A hundred-year flood event should, by definition, only happen once in 100 years. But we have had a bad weather event like this two or three times in recent years.”*

For him it is plausible and very probable that this will have effects on the insurance sector. **He points out that, against this background, the insurance premiums for reinsurance are also likely to increase.**

*“I assume that power station operators will have to face higher premiums in future”, says Anton Alt but in the same breath also concedes: “From my perspective it can very well be imagined that, with regard to an actuarial risk management, there may be some individual adaptations.”*

This can only mean that, in this case, the level of premiums could depend on the quality of the design of a power plant project. **Power plant operators with a restrained pressure pipeline could then have an actuarial advantage.**

### Solid insurance is essential

Of course, the insurance specialist is still thoroughly cautious and non-committal in his statements. In the end there is still some of the damage which is yet to be evaluated and analysed and assessed in the context of risk management. But he makes one thing very clear: *“It is essential that power plant operators are professionally insured. Particularly with this recent damage we have seen that some people here and there have lost out because they were not insured. This should obviously not happen.”*



VRS®-T positive locking restrained push-in joint with weld bead, part of the socket opening, locking element (red) and retaining chamber



Non-restrained push-in joint which was torn out during the catastrophic bad weather event



After the storm: expensive repairs for restoring the pressure pipelines



A shaft is installed additional at a low point in the power station pipeline to provide a supplementary flushing facility

An important factor here is that operators do not rely on insurers who have no experience in this area. This is also a reason why the complex subject of hydropower should be intensively dealt with by someone in the company who is known as a specialist for industry and skilled trades. *“For an operator it is essential to have technical discussions with a specialist in this area”,* says Anton Alt.

### Cast iron has defied extreme events

The bad experiences from this storm and the considerable damage caused in the Sölk valley region of Styria will not merely stay long in the memory of the small hydropower plant operators affected. These experiences are going to be a topic in the pipeline industry for a long time as, by all accounts, it must adapt itself to more frequent occurrences of catastrophic weather events of this kind.

One extremely important aspect for damage minimisation was also clearly visible here:

**Ductile iron pipeline systems with positive locking restrained joints have proved their resistance capabilities even under extreme loads and even after events of this kind,** have ensured the continued existence of the plant. One should never lose sight of this important aspect, particularly in a new project.

### Author

**Mag. Roland Gruber**  
Editor-in-chief  
zek HYDRO

Brunnenstraße 1  
A-5450 Werfen  
E-mail: rg@zekmagazin.at

### Contact at TRM

**Ing. Rudolf Stelzl**

Innsbrucker Str. 51  
A-6060 Hall in Tirol  
Phone: +43(0)664 8348083  
E-mail: rudolf.stelzl@trm.at

Roland Gruber

## Ductile iron pipes with restrained joints make difficult pipe-laying work possible in the Gastein Valley

Since the beginning of July, work has been underway in Dorfgastein, Salzburg on a new small hydropower plant for ÖBf Wasserkraft GmbH, a 100 % subsidiary of Österreichische Bundesforste AG. This is a modern high-pressure power station which in future will use the energy of the Luggauerbach mountain stream. The plant is to be built in compliance with the highest ecological standards using environmentally sound construction methods. Steep mountain slopes, geological pitfalls and an extremely narrow route are the central challenges confronting the construction team when constructing the pressure pipeline for this project.

To ensure that the penstock is built to last and to be reliable, the operator, ÖBf, is placing its trust in the quality of ductile iron pipes from the TRM company. The penstock should be ready for final pressure testing by November 2017.

### The challenge of constructing the pipeline

A natural gradient of 270 m in height forms the basic topographical condition for the new Luggauerbach power station in the beautiful Gastein Valley. To route the water from the mountain stream safely and effectively to the power station turbine, a 1,630 m long pressure pipeline is being constructed. Accomplishing the construction of the penstock is certainly one of the greatest challenges in the course of this project. As at the end of September 2017, the team from the contractor company had already completed around two thirds of the total length of the route.

*“The ratio of 270 m height to a pipeline length of 1,630 m alone suggests that the course of the route is relatively steep here. This is good from an economical point of view, but in construction terms it can present difficulties”,* explains the Project Manager of ÖBf Wasserkraft GmbH Gerhard Breitenbaumer.

Here he points out a historic scree slope directly above the steep section in the upper section of the route, for which special precautions had to be taken: the area was secured with crossbars in order to avoid accelerations in the line of steepest slope. Even this was no simple undertaking for Rumpf Bau, the construction company commissioned for the work.

*“The Rumpf Bau company really had to put their abilities to the test here. Without walking excavators and without a material ropeway, the team managed to get concrete, pipe materials and other equipment up the precipice and work on it there. For mobility in the steep terrain, raised web boards were fitted to the digger caterpillars. In this way it was possible for the machines to manoeuvre in the steep slope even in dry conditions,”* says the Project Manager.

### Extreme loads mastered

In the light of the steepness of the terrain, the difficulties with access and the geological instability, choosing the right pipe material naturally played a decisive role.



Work has been underway on the new ÖBf Luggauerbach power station in the Gastein Valley since July of this year. Currently, the time-consuming installation work is being carried out for the 1,630 m long penstock pipeline which will consist entirely of ductile iron pipes from TRM.



Fittings are also used in the construction of the power plant pipelines.



The progress is remarkable:  
The team from Rumpf Bau install and assemble 5 to 6 ductile iron pipes a day.

For the experienced hydropower operators at ÖBf there could be no doubt that the ductile iron pipe system from the Tyrol manufacturer TRM, known for quality, offers a high degree of reliability from this point of view.

*“In the end, the cast iron pipe was the best and most economical option,”* explains Gerhard Breitenbaumer about the choice which proved to be very satisfactory. Functionality and a long working life – these are the well-known plus points of iron pipes from Hall in Tirol. It is obvious that, as an operator, one is eager to avoid costly welding work and weld inspections when working in difficult terrain; above all this can be directly reflected in time saved and therefore in costs saved. Which is an important argument in favour of ductile iron pipes.

To be precise, pipe systems in dimension DN 500 with VRS®-T push-in joints were used for the 1,630 m long pressure pipeline above Dorfgastein. This is a positive locking restrained push-in joint which also withstands stresses from extremely high forces. Depending on nominal size, therefore, operating pressures of more than 100 bar or permissible tensile forces of up to 200 kN can be absorbed.

*“With this positive locking joint we can save ourselves the trouble of constructing concreted fixing points, which are not only relevant from an economic perspective but are also time-consuming to produce”,* explains Gerhard Breitenbaumer.

### Tight conditions

Another important point in the planning of the route for the pressure pipe was posed by nature protection requirements: in order to interfere as little as possible in the natural landscape of the Gastein valley, it was stipulated that the maximum width of the pipe route should be 6 m.

*“That sounds like more than it is. Particularly in the steep sections, it was not easy for the construction company to restrict the pipeline area to 6 m. But Rumpf Bau managed even this very successfully,”* are the words of praise expressed by the project manager for the construction company, which applied its broad experience to the installation of the cast iron pipes.

The pipes were installed according to the open-close method. This quite simply means that only one pipe is ever laid at a time and, as soon as it is connected, the pipe trench is closed again. This not

only makes for fast progress with the construction but it also ensures that the work is essentially independent of weather conditions. Around 5 to 6 pipes with a unit length of 6 m are currently able to be installed per day by the team from Rumpf Bau.

Thanks to this tempo, to date there has also been no problem in keeping up perfectly with the project schedule. *“Our schedule is very tightly controlled, but it does leave some reserves open”* says Gerhard Breitenbaumer. Which means, according to the project manager, that even external factors played a central role in the schedule: an instruction by the hydrographic agency had warned that work in the water run-off area should only be started as from 1st September. Another from the mountain torrent and avalanche barrier agency again only approved construction work in the area of the Mur protection embankments close to residential areas as from 15 October. Understandably, the structures had to be able to perform their protective function to 100 % right across the period of flood hazard.

## Harmonious coexistence

There are many reasons why the project schedule was kept to so well. According to Gerhard Breitenbaumer, the dry weather during this Summer was just as favourable to rapid progress as the good project management and excellent collaboration between the firms participating. Meanwhile the construction team from Rumpf Bau pulled in the empty conduit for the fibre optic cable, as well as the power cable for supplying energy to the water catchment. Basically – as at the end of September – so far the upper, and more difficult, section of the route has already been completed and the somewhat flatter area from the powerhouse to the stream crossing is on the agenda for the coming weeks.

Basically, the pipeline is planned so that everything is downhill, so one can manage without high and low points. This also relates to the stream crossing, which is constructed at considerable depth by means of culverting beneath the stream.

*“Particular attention was paid by the construction company to make sure that no stones get into the pipeline during the work. To this end, before pressure testing, a camera is run through the entire pipeline to detect any debris and then remove it if necessary. Eventually it would cause damage to the nozzles or impeller when the pipeline is commissioned if it were to reach the turbine working at 27 bars”,* explains the project manager.

## Power for 1,000 households

But it is not only the installation work which is fully on schedule. In the water catchment area and in the machine building, progress is going well. But again, the situation in the catchment area can be described as not at all easy.

In order to enable the Tyrolean weir to be securely constructed it was first necessary to install netting for protection against falling stones. In this geologically unstable mountain gorge, stones are constantly coming loose and without stone protection netting these would be a real hazard for the workers. In order to secure the precipice next to the desander structure, shotcrete was applied for the excavation from top to bottom with numerous rock bolts in lengths of 6 to 10 m.



Culverting beneath the stream represented a challenge.

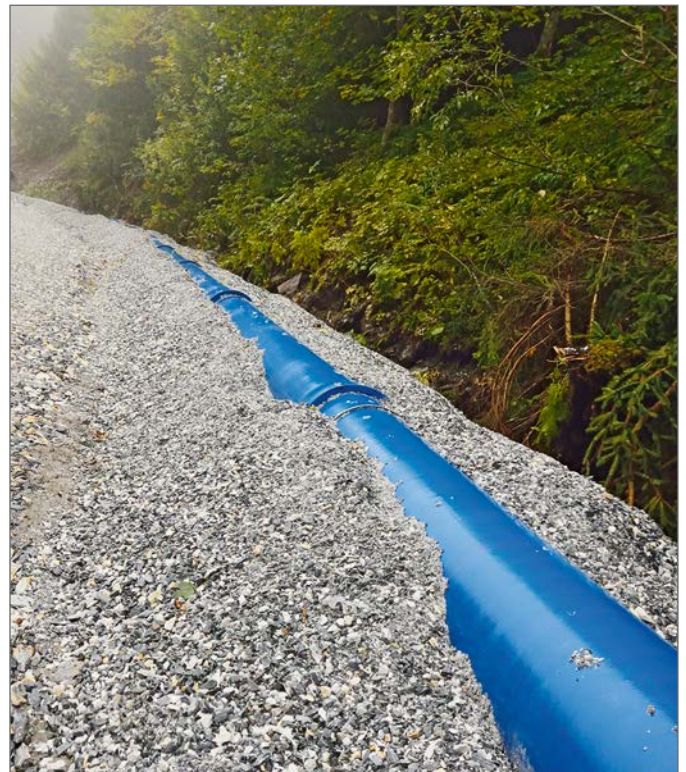

In this dimension (DN 500) pipes are capable of an angular deflection of up to 3° in the pipe socket. This means that directional changes in the route of the pipeline are easily dealt with.



Thanks to excellent project management and harmonious collaboration between the firms participating, the work was completed within the planned timeframe.

In future the Tyrolean weir will be extracting up to 500 l/s of water for electricity production in the power station and routing this to the pressure pipeline. This feed water will then be put through a 4-jet Pelton turbine which is designed for an installed capacity of 1.1 MW.

Once in operation, in a normal year the new Luggauerbach power station will produce around 4 GWh of clean energy. This will allow about 1,000 average households in Gastein to be supplied and around 3,400 tonnes of CO<sub>2</sub> emissions will be saved each year. As things stand at the moment, everything suggests that the pressure testing of the pipeline will be able to take place as early as November and the new power station will go into operation as the snow melts next Spring.

#### Technical data

- Installed flow rate: 500 l/s
- Head: 270 m
- Turbine:  
4-jet Pelton turbine
- Installed power rating:  
1.099 kW
- Generator:  
3-phase synchronous
- Pressure pipeline:  
length 1,630 m
- Nominal size: DN 500
- Material: ductile cast iron
- Make: TRM
- Construction:  
July 2017 – May 2018
- Normal output capacity:  
4.05 GWh

#### Author

**Mag. Roland Gruber**  
Editor in chief zek HYDRO

Brunnenstraße 1  
A-5450 Werfen  
E-mail: rg@zekmagazin.at

#### Contact at TRM

**Mag. Dr. Igor Roblek**  
Innsbrucker Str. 51  
A-6060 Hall in Tirol  
Phone: +43(0)664 4008848  
E-mail: igor.roblek@trm.at

Ursula Ritter

## The DÜKER plunger valve type 0816

Departure to a new dimension



Plunger valve RKV 0816 with flanged on slide crank mechanism

Valves are structural elements in pipeline and supply technology equipment. They are an essential part in a pipeline which controls the throughput of material flows in terms of volume and direction of flow. EN 736-1 defines the term **valve as a pipeline component** which influences the flow of media by opening, closing or partially blocking the flow channel or by dividing or mixing the flow of media.

Detailed classifications of areas of use depend on the construction and functional features of the connecting element. A distinction is made between shut-off valves, which interrupt the flow: gate valves, butterfly valves, taps and restricting valves or control valves. Shut-off valves which regulate the flow as regards pressure, volume and speed of flow: control valves and diaphragm valves.

The **plunger valve** (German language: Ringkolbenventil) belongs to the group of **control valves** controlled by an external power source and manually actuated by external drives, with electrical, pneumatic or hydraulic energy, as well as by floats. Their German name is more descriptive of their structural features.

**Ring:**

The flow cross-section is ring-shaped in all positions.

**Kolben:**

This is the closing device which is shaped like a plunger.

**Ventil:**

Simply the word for valve: inside the housing the plunger is moved axially in the direction of flow towards the valve seat by a crank mechanism.

The main feature of the plunger valve is the streamlined position of the closure device, which moves axially by means of a slider-crank mechanism in the direction of the pipe axis into the almost spherical housing. This is closed by pressure on the seat, which is always circular, at the valve outlet. Opening and closing are infinitely variable. The outlet of the plunger valve is variable. Depending on operating conditions, a seat ring, slotted cylinder or perforated cylinder can be used.

The advantages of the valve are **universal application possibilities** with wide control range, a low cavitation ratio, a stable flow pattern, a low noise level and low drive forces on account of the pressure-balanced closing plunger. The variable outlet part, designed as a modular system, enables the valve characteristic to be changed to suit changes in operating conditions after installation. Plunger valves are mainly used in places where pressure levels, throughput volumes and water levels in containers need to be reliably and accurately regulated: any cavitations which may occur must be controlled in such a way that no damage can be caused to the valve or to the pipeline downstream.

As a shut-off, control, check, safety and measuring device, this all-rounder performs key functions in plant and transport pipelines. This means extremely high demands in operation. A plunger valve needs to be correspondingly robust but nevertheless sensitive in design.



### Functions of the plunger valve:

- shutting off a pipeline
- regulating flow volumes, pressures and container levels
- starting and stopping pipelines behind pumps
- starting turbine and reverse flow pumps
- starting turbines installed in a bypass
- draining reservoirs via bottom outlets

The new **Düker RKV type 0816 plunger valve** fully meets the high and challenging demands in terms of construction and function. Supported by state-of-the-art Computational Fluid Dynamics (CFD) flow simulations and the use of the finite element method, a valve has come into being which is perfect in both form and function. The new plunger valve from Düker combines carefully considered technology, high quality materials, low noise output, meticulous and precise processing and the highest level of hygiene.

There are at least eight guide strips which are arranged in two groups of four in the housing, offset from each other by 45°, made of high quality stainless steel with a high degree of hardness, thus making them wear-

resistant. The guide strips are tension-free and anchored firmly in the housing, meaning that there are no welds or bolts and no mixed material zones. The product highlights are a guarantee of a **long working life**.

The main seal of the plunger valve guarantees the **highest operational reliability**: a large and robust sealing ring profile supported on the plunger, protected against the flow and arranged outside the cavitation zone and the abrasion zone. The plunger valve, with the medium flowing around the plunger and the sealed shaft bearings is practically free of dead space and hence also guarantees **optimum hygiene**. The valve plunger is made of high quality stainless steel and is characterised by a lower hardness level than the guide strips. This **reduces wear**. The plunger can be infinitely pivoted and is also **easy to replace**.

Something which is particularly to be highlighted is the **ease of maintenance of the plunger valve**. This means maximum efficiency. Hence the robust construction of the Düker RKV type 0816 reduces maintenance expenses and, consequently, the cost of spare parts to a minimum. The maintenance friendliness of the valve **reduces downtimes and hence also operating costs**. The

optimum control range, even with low volumes without an annular gap, is excellently supported by the robust, self-locking and **maintenance-free Düker slider-crank mechanism**. This **slider-crank mechanism** adjusts itself exactly to the torque progression of the valve. In the hydraulically effective final closing phase the closing speed decreases. This kinematic behaviour results in extremely soft closing. The risk of pressure surges is thus greatly minimised.

The new Düker type 0816 plunger valve stands for **“Made in Germany” perfection and quality** and combines effective parameters such as certainty, durability, reliability, and high cost effectiveness. The new, efficient plunger valve will be available in nominal sizes DN 150, DN 200 and DN 300 and in pressure stages PN 10 to PN 40 as from May 2018. Together with its engineers and its field service, the manufacturer is pleased to support you from the planning stage through to commissioning and provides first class service on all questions about the new Düker RKV 0816 plunger valve.



A section through the RKV 0816 plunger valve with a circular flow around the closing device

### Author

**Ursula Ritter**

Düker GmbH  
Hauptstraße 39-41  
D-63846 Laufach  
Phone: +49(0)6093 87-255  
E-mail: ursula.ritter@dueker.de

Roger Saner

## Replacement of the Gönhard reservoir in Aarau

New DN 400 drinking water transport pipeline

### Aarau – the capital city of the canton

The city of Aarau is the capital of the canton of Aargau and, geographically speaking, lies at the Northern edge of the Swiss Mittelland region at the transition to the Jura mountains, about half way between Basel and Zürich as the crow flies.

Some world famous personalities were born in Aarau or had their home here. The best known of these were the nutritionist Max Bircher-Benner, who invented muesli, and Nobel prize winner Albert Einstein who was educated at the Canton school in Aarau.

### Water supply for city and suburbs

In 1947, with the merging of the city's own electricity and waterworks with the gasworks, which at the time was under private ownership, the Industrielle Betriebe Aarau IBA came into being. In 2000 the company became independent and changed its name to IBAarau. The city of Aarau today has a majority shareholding of 95 % in the public limited company with holding structure.

IBAarau is to undergo organisational change and as from 2018 will appear under the new name Eniwa. With more than 320 employees, IBAarau today supplies the city of Aarau with electricity, natural gas, district heating/cooling, electric power services and drinking water, which comes exclusively from groundwater, is conveyed from three pumping stations

and is stored in three reservoirs. The drinking water is fed into the network round the clock without processing or additives as a pure natural product. Together with the residents of Aarau, the population of the surrounding suburbs of Küttingen, Untereentfelden, Erlinsbach and Eppenberg-Wöschnau – plus to some extent Schönenwerd and Gretzenbach – are supplied with extremely high-quality drinking water.

In addition, there is an emergency water supply for the adjacent municipalities of Aarau nach Buchs, Suhr and Oberentfelden.

The cityscape of Aarau is still today characterised by more than 70 public wells, which is a sign of a well-functioning water supply. Superb quality drinking water can be enjoyed from these wells "fresh from the pipe" at any time without any misgivings.



Gerechtigkeitsbrunnen – or Fountain of Justice – in the Kirchplatz in Aarau

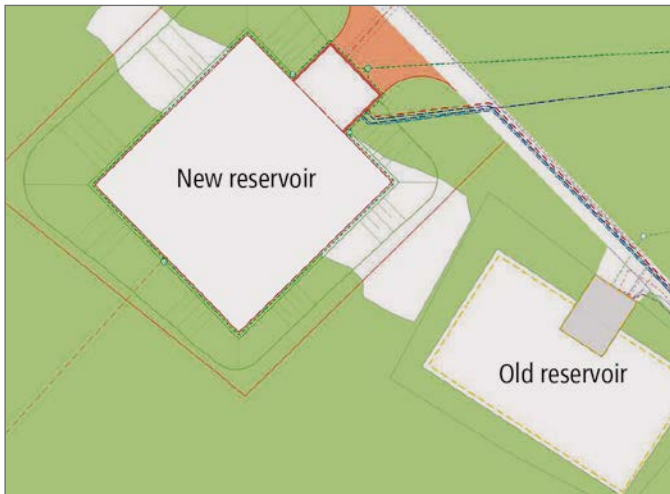

Site plan showing the old and new Gönhard Reservoir (source: IBAarau)



Operational building of the old Gönhard reservoir



Pipe store in the Gönhard Forest



The route of the pipeline alongside a field track

## Project for the new Gönhard reservoir

An analysis of the current state of the Aarau water supply infrastructure in the context of a "General water supply project (GWP)" in 2014 revealed that all three existing reservoirs – Gönhard (constructed 1941), Oberholz I (constructed 1899) and Oberholz II (constructed 1916) – are in need of renovation. In addition, their storage volume is too small to cover the long-term water requirement expected.

A new reservoir concept, which was developed by IBAarau as a result of these findings, envisages replacing the present Gönhard reservoir by a larger reservoir and, once this is put into operation, dismantling the three old reservoirs (Gönhard and Oberholz I and II).

The new Gönhard water reservoir, as a "project of the century", will ensure the long-term supply of clean and healthy drinking water to coming generations in the region of Aarau. From an economic point of view, combining the necessary water capacities in a single new and centrally located water storage facility will increase efficiency in terms of both operation and maintenance.

The construction of the new central Gönhard reservoir will ensure that the natural resource of water is sustainably managed for future generations.

## New DN 400 drinking water transport pipeline

In the run-up to the construction of the new reservoir, which was commenced in Summer 2017, in order to maintain the supply of water an additional DN 400 drinking water transport pipeline had to be laid. Thanks to this back-up main supply pipeline there is now sufficient drinking and extinguishing water available at all times within the Aarau supply area.

The following deadlines are planned:

- Construction of the transport pipeline February to June 2017
- Construction of the reservoir July 2017 to September 2019
- Dismantling of the old reservoirs subsequently

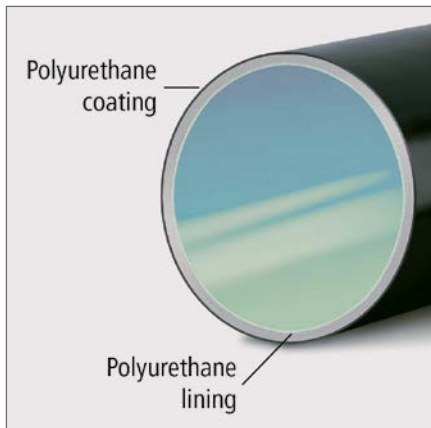

ECOPUR pipe – layer structure with PUR coating/lining

The construction work for the new transport pipeline was able to be tackled on schedule in February 2017 and it started right at the location of the new reservoir in Gönhard Forest, a popular local recreation area on the outskirts of the city of Aarau.

The route of the pipeline runs alongside a path in the forest area – from Sennweg via Höhenweg, the old Distelberg road – to the start of the built-up area of the city of Aarau.

In the last stage of construction, the DN 400 drinking water pipeline will be installed in a residential district until it connects up with the pipeline network in the Goldernstraße. This last part of the pipeline construction project will be carried out in 2018 in collaboration with the city of Aarau, when the construction of other pipelines (gas, electricity, telecoms) is scheduled.

Looking forward to the further progress of the project, the drinking water transport pipeline will also continue on until it turns into Kantonsstraße/ Entfelderstraße so that, during later renovation work, it can be connected to the drinking water supply network and the residential quarter will not be further affected.

For the new water transport pipeline, IBAarau is putting its trust with conviction in ductile iron pipes of the vonRoll ECOPUR type with reinforced coating to EN 545 [1].

The full-protection pipes with integral polyurethane lining and exterior coating which have been tried and tested over decades can be used even in highly aggressive soils without any further protective measures. And the HYDROTIGHT restrained push-in joint guarantees simple and secure handling of the cast iron pipe system as well as very efficient assembly.



Assembling a HYDROTIGHT push-in joint with hydraulic pipe-laying equipment



Installation under difficult conditions where pipelines cross

Minor directional changes in the route can be handled by the angular deflection inherent to the push-in joints. For more major changes in direction, for branches etc., a complete range of fittings is available.

vonRoll ECOFIT type fittings are coated with epoxy resin to EN 14901 [2] and in accordance with the enhanced requirements of RAL GZ 662 [3].

The use of ECOPUR ductile iron pipes will make sustainable and secure operation of the new main supply artery of the regional water supply in and around Aarau possible for decades to come.



MK 45° bend installed



Stock of fittings at the construction site

## Summary

With the new Gönhard water reservoir the long-term supply of clean drinking water in the region of Aarau will be secured. To this end, an additional DN 400 drinking water transport pipeline has been constructed. Thanks to this back-up main supply pipeline there is now sufficient drinking and extinguishing water available at all times within the Aarau supply area.

For the new water transport pipeline, IBAarau is putting its trust in ductile iron pipes of the vonRoll ECOPUR type with integral polyurethane lining and coating which can be used in soils of any level of aggressiveness without further protection measures.

With the HYDROTIGHT restrained push-in joint, simple and secure handling as well as very efficient assembly of the cast iron pipe system is achieved.

## Bibliography

- [1] EN 545  
Ductile iron pipes, fittings and accessories and their joints for water pipelines – Requirements and test methods 2010
- [2] EN 14901  
Ductile iron pipes, fittings and accessories – Epoxy coating of ductile iron fittings and accessories (for increased loads) – Requirements and test methods 2006
- [3] RAL GZ 662 quality and test requirements  
Schwerer Korrosionsschutz von Armaturen und Formstücken durch Pulverbeschichtung  
[Heavy duty corrosion protection of valves and fittings by powder coating]  
2008-01

## Author

### Roger Saner

vonRoll hydro (suisse) ag von  
Roll-Strasse 24  
CH-4702 Oensingen  
Phone: +41(0)62 3881237  
E-mail:  
roger.saner@vonroll-hydro.ch

### Development, planning and construction

IBAarau Trinkwasser AG  
Obere Vorstadt 37  
CH-5000 Aarau  
Phone: +41(0)62 8350040  
E-mail:  
trinkwasser@ibaarau.ch

Roger Saner

## Water supply for Attisholz-Süd

Development for the American Biotech company

Cellulose Attisholz AG, established in 1881, was the first and only cellulose factory in Switzerland. In 2002 and after years of turbulent company history, the works located to the East of the canton capital of Solothurn was sold to the Borregaard company, a subsidiary of the Norwegian conglomerate Orkla. After the international market for cellulose deteriorated further in the following years, the cellulose factory was closed in 2008.

### An industrial wasteland will be brought back to life

On what became the largest industrial wasteland in Switzerland, the former location of the Attisholz cellulose factory, another piece of Solothurn industrial history is about to be written after the development and reorganisation of the area.

To the South of the River Aare on a piece of ground in the district of Luterbach measuring 50 hectares – which is the equivalent of more than 80 football pitches – a workplace centre of national importance is being created.

Already since 2016 a highly modern biopharmaceutical production plant for the American Biopharma company Biogen is being built on the site. The investment volume is around 1.5 billion Swiss francs. The new production complex in which drugs will be produced is located on a 22 hectares area of land.

In the first stage of construction (preparation phase 1) two production workshops will be erected as a modular construction which will contain up to 600 workplaces. If necessary, further so-called pro-

duction cells can be added and in this way production capacities can be expanded. When it is finally completed, up to 1,750 people will be employed in the new factory. As from 2019 the production plant with its associated laboratories, offices, warehouses and supply buildings in the Luterbach works should go into operation (<https://biogensolothurn.ch/projekt/>).



A view northwards across the Luterbach Biogen construction area

### Development and water supply plan for the Biogen construction site

The Attisholz-Süd construction area is going to be developed with the construction of more than 1,000 metres of new roads, the expansion and relocation of 400 metres of regional roads and the construction of a new roundabout. For the new infrastructure leading to the various industrial and commercial premises, the necessary utility lines will also have to be constructed. The largest project in the Attisholz-Süd construction area is the building of the new production plant on the Biogen area, for which the development and the installation of around ten supply and disposal pipelines will have to be coordinated. Excavation work will be made more difficult by the construction work being carried

out above ground with the correspondingly active construction site traffic.

In advance of the construction work, the owners needed to check the water situation to see whether the water supplies can be adapted to the altered conditions due to the change of use. This was done in the context of a partial revision of the general water supply plan (GWP) of the district of Luterbach.

In Switzerland, the legal GWP guidelines regulated by the cantonal authorities form the basis for the production of a general water supply plan, which has to be formally approved by the government of the canton, or state council (GWP guidelines for the Canton of Solothurn, see [1]).

A general water supply plan must be periodically checked every 10 to 15 years and adapted to altered conditions. It controls the development programme in the supply area and serves to ensure a supply of drinking water in emergencies. In addition, the water supply plan must be coordinated with the other utilisation plans of the communities and the planning of neighbouring and regional water supplies. The GWP is also the basis of support with state contributions and subsidies.



vonRoll ECOPUR full protection pipe with reinforced coating to EN 545 for use in all types of soil, even in highly aggressive soils



Hydraulically smooth PUR internal coating with minimum roughness offers the best flow values

## The general water supply plan was changed

In the legally binding general water supply plan (GWP) of the district of Luterbach, the 22 hectare Biogen area was already considered as an industrial zone with a normal industrial water requirement for Luterbach.

However, Biogen needs much larger volumes of water for its biopharmaceutical production plant. By final completion, 3,300 m<sup>3</sup>/d is planned. This exceeds the current water production of the entire district of Luterbach of 760 m<sup>3</sup>/d several times over. Therefore, water procurement had to be re-analysed and considered on a larger perspective.

The district of Luterbach is a member of the regional group water supply for Lower Leberberg (GWUL), which includes eight surrounding districts. At the same time there are also connecting pipelines to the Solothurn region water association (WARESO), the Grenchen group water supply (SWG) and the Derendingen water supply (EWD).

The conclusion of the detailed water balance produced was that, with the water extraction plant of the GWUL, the Biogen area can be

supplied up to preparation stage 2. Water usage in this phase is 2,200 m<sup>3</sup>/d. Only on final completion with a required water volume of 3,300 m<sup>3</sup>/d will additional water have to be procured from the surrounding suppliers and the storage capacities of the reservoirs expanded.

## Expansion and extension of the Attisholz-Süd water pipeline network

For the development of the new water and extinguishing water supply for the construction area, the competent Luterbach authority decided in favour of ECOPUR type ductile cast iron full protection pipes from the Swiss manufacturer vonRoll. This pipe system has been used for years for the renewal of the water infrastructure in the area. ECOPUR ductile cast iron pipes have an integral interior and exterior coating of polyurethane (PUR), which is classified according to EN 545 [2] as a reinforced coating suitable for use in soils of any level of aggressiveness. With the use of the impermeable cast iron pipe system with integral interior and exterior coating of polyurethane (PUR), the operational security of the water supply to the old industrial location required in the GWP is ensured. The

hydraulically smooth polyurethane (PUR) lining with minimal roughness  $k \leq 0.01$  mm offers the best flow values with a lower pumping effort and energy consumption and so reduces the operating costs for transporting the groundwater.

ECOFIT fittings and VS 5000 shut-off valves with integral epoxy coating to EN 14901 [3] and the enhanced requirements according to GSK/RAL- GZ 662 [4] complete the system.

All vonRoll socket system products – ductile cast iron pipes, fittings and shut-off valves – were secured with its own flexible vonRoll HYDROTIGHT restrained joint system.

The route of the pipeline for the basic development of the large construction sites in the Attisholz-Süd area lies for the major part in public streets and paths.

Because of the change of use of the land with the new Biogen construction and with further building projects planned, existing water supply and transport pipelines had to be relocated before or during the construction work above ground.



vonRoll VS 5000 full protection boltless gate valve, upper/lower part and HYDROTIGHT double-chamber socket



vonRoll HYDROTIGHT push-in joints with internal and external thrust protection



Relocation of a DN 400 transport pipeline because of a new roundabout



ECOPUR DN 400 restrained pipe with thrust protection (Fig. 2807A)

Because the building of the new Biogen production plant needed a great deal of water for construction purposes, even before the start of construction a new DN 200 ring main was also constructed along the northern edge of the construction site to ensure supply of extinguishing water.

The following new transport and supply pipelines for drinking and extinguishing water have been installed for the development of the Attisholz-Süd area:

- ECOPUR DN 125 mm, length 40 m
- ECOPUR DN 150 mm, length 720 m
- ECOPUR DN 200 mm, length 1.425 m
- ECOPUR DN 250 mm, length 90 m
- ECOPUR DN 400 mm, length 430 m

Thanks to the complete and easily assembled ECOSYS full protection pipe system with the ECOPUR pipe at its core, the installation of the new water supply pipelines was able to be managed very flexibly and efficiently. Connection pipelines and their transitions to the old grey cast iron pipelines were performed reliably with the system components available. Even where conditions were more difficult, such as when crossing beneath existing works pipelines with minimal working space, the cast iron system with its simple but well thought out technology was exemplary.

The volumes of extinguishing water required by the building insurance demanded a special solution for procuring the water. With the high-performance vonRoll type industrial hydrants (Fig. 5532) even this requirement of the general water supply plan could be met.





Preassembly of an ECOFIT DN 400 double-socket bend outside the trench profile with hydraulic pipe-laying equipment



Shut-off unit with vonRoll DN 400/200 butterfly valves, preassembled in the factory



Assembly of the new DN 400 transport pipeline made more difficult because of the need for it to run beneath factory supply pipelines



DN 400 double-socket bend before the pipeline runs beneath existing works pipelines



vonRoll high-performance industrial hydrants (Fig. 5530) with Storz 110 mm lateral outlets and Storz 75 mm central outlet

## Bibliography

- [1] Generelle Wasserversorgungsplanung (GWP), Richtlinie zur Erstellung der GWP. Download edition 01-2006: [https://www.so.ch/file-admin/internet/bjd/bjd-afu/pdf/wasser/333\\_rl\\_01.pdf](https://www.so.ch/file-admin/internet/bjd/bjd-afu/pdf/wasser/333_rl_01.pdf)
- [2] EN 545  
Ductile iron pipes, fittings and accessories and their joints for water pipelines, 2010
- [3] EN 14901  
Ductile iron pipes, fittings and accessories 2006
- [4] RAL GZ 662 quality and test requirements  
Schwerer Korrosionsschutz von Armaturen und Formstücken durch Pulverbeschichtung [Heavy duty corrosion protection of valves and fittings by powder coating], 2008-01

## Author

### Roger Saner

vonRoll hydro (suisse) ag  
 von Roll-Strasse 24  
 CH-4702 Oensingen  
 Phone: +41(0)62 3881237  
 E-mail: roger.saner@vonroll-hydro.ch



**EADIPS®** European Association for  
**Ductile Iron Pipe Systems**  
**FGR®** Fachgemeinschaft Guss-Rohrsysteme

## NEWSLETTER

Dear Readers,

Again and again, durability under high operating pressures proves to be a reason for using ductile iron pipe systems. This is why Kreiswerke Cham opted for ductile iron pipes when relocating a transport pipeline with an operating pressure of 30 bars.

The article about the construction of a supply pipeline in the Swiss village of Villmergen, known as the site of the two historic battles in the religious wars of the Swiss Federation (the "battles of Villmergen") in 1656 and 1712, again stresses this concept. Valves and fittings in ductile cast iron provide the ventilation for a ductile cast iron transport pipeline in the area of a culvert here. In another contribution, the Newsletter addresses a perennial issue in the field of sewage pipelines: root penetration and push-in joints. The diffusion tightness of the pipe system plays a decisive role in demonstrating the resistance of cast iron pipe systems against root penetration. Finally, I would like to remind you of the Wasser Berlin 2017 exhibition, taking place at the end of March 2017. There you will be able to find all you need to know about the performance capabilities of ductile iron pipe systems, both in the exhibition halls and at showcase construction sites in the city area of Berlin.

Have an enjoyable and stimulating read  
Sincerely yours  
Christoph Bennerscheidt

### More than 30 years' experience with ductile iron pipe systems for snow-making equipment

In the 1980's when snowfall was low, the need grew for snow-making facilities in the Alps. The operators of snow-making equipment were in search of a robust, reliable and easy-to-handle piping system which ensures of up to 100 bars without problems. These criteria were - and still are today - met by ductile iron pipes with restrained push-in joints. Tiroler Rohre GmbH ventured into the area of snow-making equipment even now. 30 years later, the extension and renovation of the snow-making equipment in the Alps is being illustrated by two current projects in the districts of Seefeld and Ischgl in the Tyrol, where ductile iron pipes with VRS®-T socket joints from Tiroler Rohre GmbH are being used.

#### Snow for the Nordic Ski World Championships in 2019

Seefeld in the Tyrol was named - for the fourth time - as the venue for the FIS Nordic Ski World Championships of the Fédération Internationale de Ski. The snow-making equipment is already being expanded so that, in addition to the existing equipment, a new basin for a seamless cover of snow for the entire cross-country storage reservoir, for the reservoir piping system and for distributing the water to the 100 km of ductile iron pipes in nominal sizes DN 80, DN 200, DN 250 and DN 400 from Tiroler Rohre GmbH. In June 2017, construction work was started on the conversion and extension of the infrastructure equipment. The construction project will be completed in the next few months in order to be able to host what is to come in the 2019 World Championships at the forthcoming cross-country skiing World Cup Race, the Kaiser Maximilian Lauf, Austrian Championships and the "PRE WSC".



### Clean water - clean electricity for Dorfgastein

The Forestry Office (Österreichische Bundesforste AG or OBF) has special responsibility for the natural resources of the Republic of Austria. Sustainability is the number one principle here: only take out as much as you need.

To supply around 1,000 households with clean electricity in future, the OBF decided to build a hydropower plant in the district of Dorfgastein. This is a modern high-pressure power plant which draws energy from the water of the Luggaubach. This new power plant has been constructed in accordance with the highest ecological standards, using environmentally friendly construction methods. For example, the flow velocity of the stream has been determined according to the latest legal requirements. In order to integrate the plant into the natural landscape of the Gastein valley as low as possible, the width of the route during construction was limited to 6 m. Once commissioned, the small hydropower plant with an installed capacity of 1,099 kW will reduce CO<sub>2</sub> emissions by approximately 3,400 tonnes per year.



Assembling the pressure pipeline with VRS®-T restrained push-in joints in the pipe trench



Backfilling the pipe trench with the soil previously excavated

## Always current, always informed

The periodically published Newsletter provides specialists in the sector with the latest information on interesting European pipeline Projects as well as the many and varied activities of EADIPS FGR.



Register at:  
[eadips.org/newsletter-e/](http://eadips.org/newsletter-e/)

### New drinking water transport pipelines for Bellinzona in the Swiss Canton of Ticino



The route of the drinking water pipeline between the Ticino River in the Swiss Canton of the same name and the A2.

Bellinzona is the capital and, after Lugano, the second largest city in the Canton of Ticino (Switzerland).

For the past 6 years Azienda Municipalizzate Bellinzona AMB, the utility company for the city of Bellinzona, has been implementing the stages of a major project which will ensure a secure, top quality supply of drinking water for the city of Bellinzona and the suburbs of Semerina, Monte Carasso, Gnosca and Gorduno for the coming decades.

The philosophy behind the project is the reliable operation of existing and new productive wells and sources. Facilities with insufficient capacity or those located in densely built-up risk areas are to be abandoned.

Because of this, 5 existing wells close to the football stadium in the centre of Bellinzona will be taken out of operation. The volumes of drinking water lost in this way will be provided by the construction of 2 new wells in a groundwater protection zone in the districts of Gorduno and Gnosca. These new water resources will be integrated into the drinking water distribution network of the participating municipalities.

The total investment for this future-oriented project amounts to more than 20 million CHF. It is planned that this intercommunal water supply system will be put into operation in the middle of 2017.

# Imprint

## Picture credits

Except where otherwise stated, the pictures appearing in the text were supplied by the authors.

## Production

schneider.media

## Published by and copyright

EADIPS®/FGR®

European Association for Ductile Iron Pipe Systems/ Fachgemeinschaft Guss-Rohrsysteme e. V.  
Doncaster-Platz 5  
45699 Herten/Germany

Telephone: +49 (0)2366 9943905

Fax: +49 (0)2366 9943906

E-Mail: [info@eadips.org](mailto:info@eadips.org)

## Editorial staff

Dipl.-Ing. Christoph Bennerscheidt

Dr.-Ing. Jürgen Rammelsberg

Detlef Thomas

## Editor

Dipl.-Ing. Christoph Bennerscheidt

## Press date

17 January 2018

## Disclaimer

Whilst every care has been taken in the compilation of the material, information and content contained in this Annual Journal, and every effort is made to ensure that it is both accurate and up-to-date, the FGR/EADIPS makes no representations or Technical accuracy of such material, information and content. Whilst all reasonable steps have been taken to ensure that this Annual Journal is free from computer viruses, we accept no liability in respect of any loss, cost, damage, inconvenience or expense suffered as a result of accessing this Annual Journal. We also reserve the right to make, at any time and without prior notice, amendments or additions to or deletions from the material, information and content contained in this Annual Journal. Through this Annual Journal you are able to access links to third-party websites which are not under the control of the FGR/EADIPS. We have no control over the nature and content of these third-party websites or over any changes made to them. We therefore accept no liability for the content of such third-party websites to which links are provided in our Annual Journal, or for links to further websites which are provided on such third-party websites.

## Reproduction

Text, data, software and graphics appearing in this Annual Journal may be reprinted, reproduced, copied or used in other ways for non-commercial, private, education or training-related purposes provided always that the text, data, software and graphics are not modified and that an indication that the FGR/EADIPS is the copyright owner appears on every copy. Prior written consent must be obtained from us for any other use. Reprint of complete articles with source indication is allowed, specimen copy is requested.

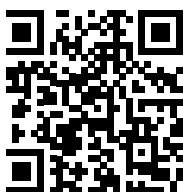

[eadips.org](http://eadips.org)

# Members of EADIPS FGR

## Full Members



## Sponsoring Members



Member of the Woco Group

## Members location

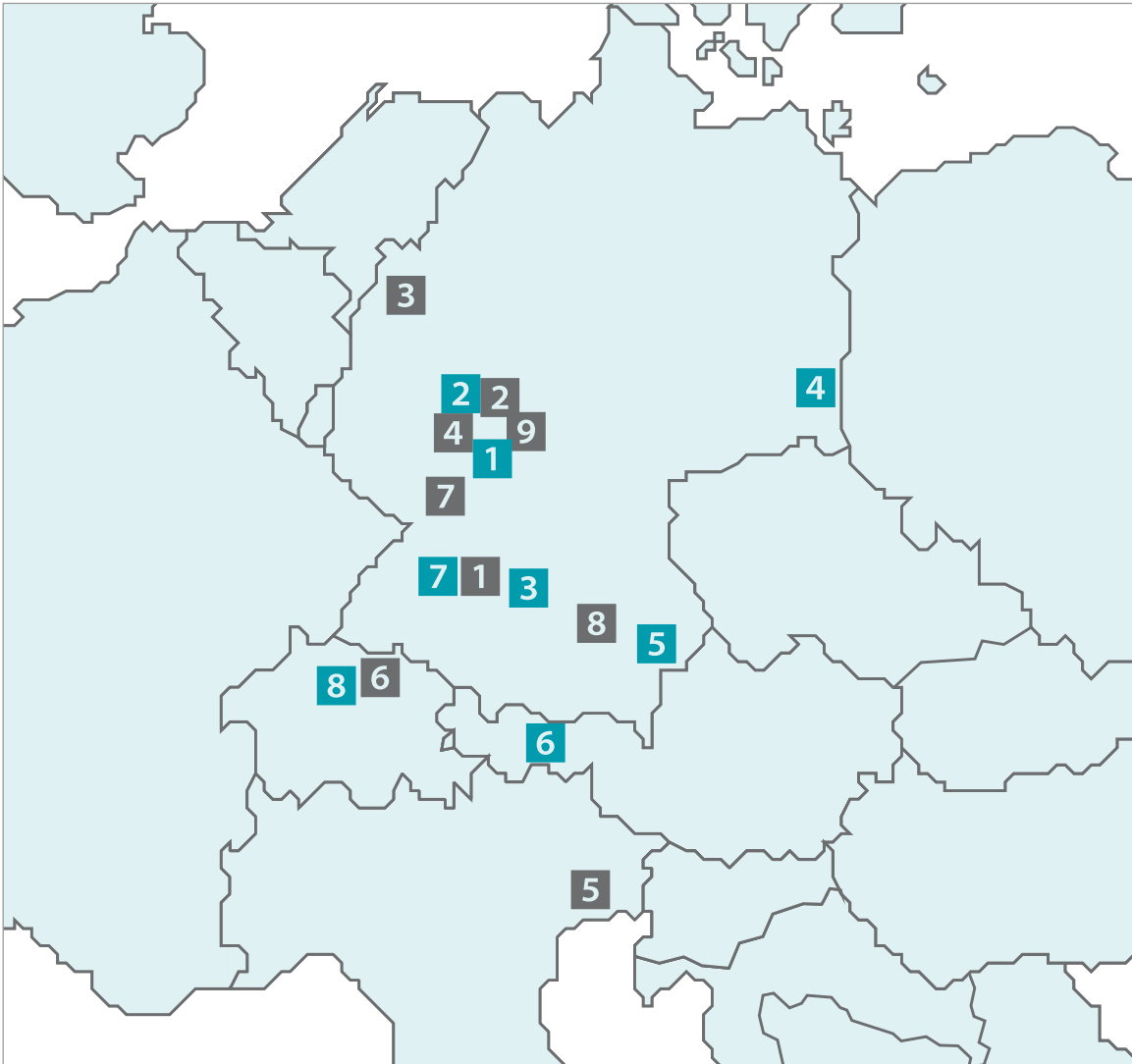

### Full Members

- 1 Düker GmbH
- 2 Duktus (Wetzlar) GmbH & Co. KG
- 3 ERHARD GmbH & Co. KG
- 4 Keulahütte GmbH
- 5 Ludwig Frischhut GmbH und Co. KG
- 6 TIROLER ROHRE GmbH
- 7 vonRoll hydro (deutschland) gmbh
- 8 vonRoll hydro (suisse) ag

### Sponsoring Members

- 1 Akzo Nobel Powder Coatings GmbH
- 2 Friedrichshütte GmbH
- 3 Rhein-Ruhr Collin KG
- 4 Saint-Gobain Building Distribution Deutschland GmbH
- 5 SATTEC DBS GOMMA SRL
- 6 THM Hagenbucher AG
- 7 Träger + Entenmann KG
- 8 Vertriebsgesellschaft für Tiefbau und Umwelttechnik mbH + Co. KG
- 9 Woco IPS GmbH

# Notes





**EADIPS®**

**FGR®**

**European Association for  
Ductile Iron Pipe Systems**

**Fachgemeinschaft Guss-Rohrsysteme**



### **Economically superior**

Investing in ductile iron pipe systems pays for itself in low installation and operating costs with, at the same time, an extremely long operating life!

### **Environmentally superior**

Ductile iron pipe systems can be shown to produce true sustainability!

### **Technically superior**

The technical performance of ductile iron pipe systems ensures the highest safety and reliability in all areas of the water industry!