

# DUCTILE IRON PIPE SYSTEMS

The Annual Journal of the European Association for Ductile Iron Pipe Systems · EADIPS®

# 50



Sustainably superior –  
ductile iron pipe systems



- 4      **Letter from the editor**
- 5      **Abstracts**
- 8      **Sustainability in water management**  
**Ductile cast iron creates value**  
*By Ulrich Päßler*
- 13     **Historical view**  
**The story of drinking water systems through the centuries**  
*By Jürgen Rammelsberg*
- 20     **Production of ductile fittings**  
**Quality assurance through modernisation and increased flexibility**  
*By Max Altmannshofer*
- 22     **DN 400 and DN 600 valves and fittings**  
**The Lusatian metropolis of Cottbus puts its trust  
in ductile cast iron valves and fittings**  
*By René Pehlke*
- 25     **Product development of ductile cast iron valves**  
**Numerical simulation & rapid prototyping in the foundry at JMA Hodonín,  
a VAG-Armaturen GmbH company**  
*By Radim Hnilica*
- 29     **DN 150 to DN 300 valves**  
**A milestone in water supply**  
*By René Mattern and Sebastian Ebert*
- 31     **Modular concept for hydrants**  
**Time saving and flexibility in the installation of hydrants thanks  
to a new modular system**  
*By Daniel Buri and Andreas Schütz*
- 34     **DN 1200 butterfly valves**  
**DN 1200 butterfly valves for Fernwasserversorgung Elbaue-Ostharz GmbH –  
valve replacement in the raw water tunnel at Wienrode waterworks**  
*By Frank Schmidt and Ursula Ritter*
- 36     **CLICK® modular house connection system**  
**Simple and more reliable house connection system  
without parts that will get lost**  
*By Andreas Schütz*

- 40**      **Replacement of a water transport pipeline with DN 400 ductile iron pipes**  
**The steady renewal of the “Auer Ring” long-distance drinking water system in the Western Ore Mountains in Saxony – an interim report**  
*By André Clauß*
- 47**      **Material optimisation of cast iron pipe systems with fracture mechanics**  
**Kanzingbach power station (Tyrol) with a high boost in output – increased security provided by “leak-before-break” fracture mechanics design of turbine pipes**  
*By Christian Auer, Andreas Hammer, Friedrich Karau, Sven Kunow, Anton Rass, Werner Rudig and Oswin Schüller*
- 55**      **Horizontal directional drilling technique DN 500**  
**Trenchless through the Badrina biotope – enthusiastic visitors follow the pipe pulling-in process at the site open day**  
*By Uwe Hoffmann and Stephan Hofmann*
- 59**      **Bed-load barrier for flood protection**  
**Torrent bed-load barrier on the Schnanner Bach**  
*By Werner Siegele and Christoph Aigner*
- 63**      **DN 80 to DN 125 snow-making system**  
**Guaranteed snow for the ski jumping hill in Planica**  
*By Romana Bohm*
- 65**      **Energy efficient transport of lake water for heat generation**  
**District heating pipeline with water from Lake Geneva in La Tour-de-Peilz (CH)**  
*By Vincent Voyame and Andreas Schütz*
- 70**      **Pre-insulated cast iron pipe system**  
**The planning of pre-insulated cast iron pipelines**  
*By Stephan Hobohm and Karl-Wilhelm Römer*
- 78**      **Imprint**
- 79**      **Logos of the full members of EADIPS®/FGR®**  
**Logos of the sponsoring members of EADIPS®/FGR®**

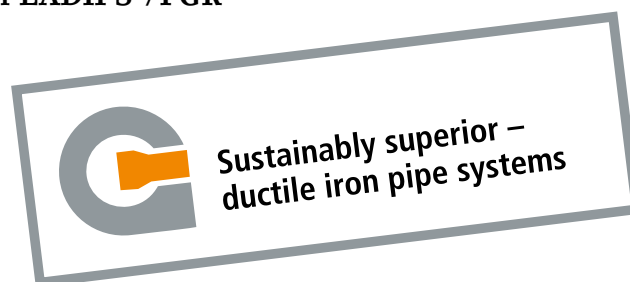

Dear Readers,

It is with pleasure and a degree of pride that I present issue **50** of the EADIPS®/FGR® annual journal, which is also an anniversary edition. The “Fachgemeinschaft Gußeiserne Rohre – fgr”, as it was then called, published the first annual journal in 1966. While it initially reported on cast iron pipes and fittings, these days the cast iron pipe system includes pipes, fittings and valves in ductile cast iron.

The subjects covered by the articles in the annual journals demonstrate the level of know-how and innovative strength of the cast iron industry over the years. Worth mentioning in particular for example is the progress from grey cast iron to ductile cast iron, or the advance from non-restrained to restrained push-in joints. And a great deal has been invested in adapting linings and coatings to the requirements of the water industry, thereby also meeting demand for environmental protection.

The anniversary edition contains an article entitled “Ductile cast iron creates value” which considers the various sustainability aspects of ductile cast iron pipe systems, including for example the reduction of noise immission by the use of trenchless techniques with ductile cast iron pipe systems. The article on “The history of the drinking water systems over the centuries” looks at the innovations which the iron pipe industry has produced, particularly in recent decades.

As it does each year, the **50<sup>th</sup>** issue of the EADIPS®/FGR® annual journal also illustrates the widest variety of applications of ductile iron pipe systems.

I wish you much pleasure in reading the anniversary issue

Yours



Raimund Moisa



Raimund Moisa

the outgoing  
managing director



Christoph Bennerscheidt

the future  
managing director

One further message concerns a change in the management of EADIPS®/FGR®. On reaching retirement age and after almost 10 years of responsibility as managing director of EADIPS®/FGR® it is now time for me to say goodbye to you. I would like to thank all the authors for their informative contributions, the editorial team for their tireless efforts and yourselves, dear readers, for your loyalty and interest. As from 01.04.2016 Mr Dipl.-Ing. Christoph Bennerscheidt will succeed me as managing director of EADIPS®/FGR®.

I wish him every success and good fortune and a continuing loyal readership.

Sincerely

Yours



Raimund Moisa

### Ductile cast iron creates value

Ulrich Päßler ..... 8

For quite some time now it has been clear to see that price alone is not the only decision-making criterion when it comes to durable capital assets because it takes no account of the aspect of a sustainable investment strategy. This applies to supply infrastructures in particular because the proportion of material costs to overall costs is usually under 10 %. This article summarises the innovative properties of ductile cast iron as a material in terms of its effect on the various life phases of supply and sewage disposal pipelines. These include its sustainability throughout the entire life cycle and especially the ability of pipelines to operate for decades without problem and without detriment to the drinking water quality as well as the pioneering role of ductile iron pipe systems in the establishment of the trenchless installation techniques, which also makes an important contribution to environmental protection in towns and cities. And not least it also includes the use of resources in the production of ductile iron pipe systems which, without exception, are made of recycled scrap steel and iron. Ductile iron pipe systems offer a secure route to true sustainability.

### The story of drinking water systems through the centuries

Jürgen Rammelsberg ..... 13

The “50<sup>th</sup>” anniversary issue of the EADIPS®/FGR® annual journal has been an occasion to look back over the history of 500 years of drinking water transport and distribution. This area of life is inseparably linked to the traditional material of “cast iron”: it has put its stamp on the development of drinking water supply for half a millennium but, with a constant influx of improvements, optimisations and innovations over this timespan, it has nevertheless remained ever young. The cast iron pipe industry, in collaboration with its users, has always managed to keep abreast of the latest state of the art with a modern and sustainable piping system comprising pipes, fittings and valves.

### Quality assurance through modernisation and increased flexibility

Max Altmannshofer ..... 20

A foundry has to do battle in a market with constantly increasing requirements for flexibility. Production batches are becoming ever smaller while the expense of retooling increases. At the same time, energy consumption has to be reduced and environmental and occupational safety requirements are becoming stricter. In such cases only decisive action can help: the latest medium frequency induction furnaces provide the solution. Performance and flexibility increase, costs decrease and process reliability improves.

### The Lusatian metropolis of Cottbus puts its trust in ductile cast iron valves and fittings

René Pehlke ..... 22

Ensuring the security of the drinking water supply is the most important task of a water supplier. He can fulfil this task more easily and reliably if he places his trust in the competence of his supplier and not simply on the “cheapest” offer. Valves and fittings in ductile cast iron as a complete package from a single supplier offer the assurance of the problem-free construction and sustained service of a supply network with a long working life. More and more clients are beginning to appreciate this concept.

### Numerical simulation & rapid prototyping in the foundry at JMA Hodonín, a VAG-Armaturen GmbH company

Radim Hnilica ..... 25

Previously castings were developed in a laborious sequence of individual steps before they were ready for series production. This involved pattern as well as gating and feeding system being optimised by sample castings and subsequent modifications until their quality reached an acceptable level. With simultaneous engineering these stages can overlap and be shortened in time by computer-aided construction, strength calculation using FE methods and filling and solidification simulation. The casting takes shape with its gating and feeding system on the computer before the real moulding pattern is produced. A further acceleration of the process is achieved by using 3D printers to

produce the moulding pattern. While this optimisation phase used to take weeks and months, these days this can be shortened to just a few days.

### **A milestone in water supply**

*René Mattern and Sebastian Ebert* ..... 29

Regional economic development is usually accompanied by an increase in water supply requirements. Although a more than 100 year old reservoir may well serve its primary purpose of supplying the local community, as an essential part of a more far-reaching regional water supply it needs components (pumps, valves, etc.) to the very latest standards of technology in order to operate sustainably. Valves in spheroidal graphite cast iron provide the best conditions for this.

### **Time saving and flexibility in the installation of hydrants thanks to a new modular system**

*Daniel Buri and Andreas Schütz* ..... 31

An exemplary illustration of the increasingly complex requirements for system components for drinking water networks can be seen in what was originally a simple component – the bottom part of a hydrant. First of all, components of this kind must meet the demand for durability and functional reliability. Then, as far as possible, their height should be able to be adjusted manually, without additional tools, in the pipe trench and it should be possible to exchange the valve in both unpressurised and pressurised states. Development has resulted in a smart system construction kit.

### **DN 1200 butterfly valves for Fernwasserversorgung Elbaue-Ostharz GmbH – valve replacement in the raw water tunnel at Wienrode waterworks**

*Frank Schmidt and Ursula Ritter* ..... 34

When it comes to maximum security, longevity and hygiene for drinking water production equipment, fully-enamelled ductile cast iron components are right at the top of the operator's wish list. Therefore when large DN 1200 butterfly valves needed to be fitted in narrow dam outlet structures, only expertly engineered constructions could be considered. Düker's double eccentric butterfly valves with full etec enamelling (inside and outside) meet the requirements of a major German long-distance water supplier to perfection.

### **Simple and more reliable house connection system without parts that will get lost**

*Andreas Schütz* ..... 36

The trend towards self-explanatory installation technology with modular elements for drinking water supply is continuing: wherever possible and if necessary system components should be able to be assembled without small parts which can get lost, without tools and without written assembly instructions; they should also have integral corrosion protection suitable for all soil types for a long, low-maintenance service life. While domestic connection adapters used to be simple elements, often made by the millwright, today's house connection systems consist of small high-tech components which meet the client's every need.

### **The steady renewal of the "Auer Ring" long-distance drinking water system in the Western Ore Mountains in Saxony – an interim report**

*André Clauß* ..... 40

Simply for geological and topographical reasons alone, the renewal of a drinking water transport pipeline in the densely wooded region of the Western Ore Mountains is no straightforward undertaking. Thanks to modern piping systems with their highly developed structural design methods, joint technologies and corrosion protection techniques, projects of this kind can be handled without problem. In the case illustrated here, the planning engineers were confronted with a fairly unusual additional challenge in the form of the soft, unbuffered water in the reservoir which, in conjunction with the cement mortar lining of the pipe, can be subject to an inadmissible increase in its pH value in stagnation phases. By using a proven method, endorsed in the DVGW regulations, of applying carbon dioxide gas under pressure in individual sections of the pipeline before acceptance and commissioning it was possible to ensure that the drinking water in the "Auer Ring" always meets the directives of drinking water legislation.

### **Kanzenbach power station (Tyrol) with a high boost in output – increased security provided by "leak-before-break" fracture mechanics design of turbine pipes**

*Christian Auer, Andreas Hammer, Friedrich Karau, Sven Kunow, Anton Rass, Werner Rudig and Oswin Schüller* ..... 47

The use of ductile iron pipe systems for penstock pipelines is constantly increasing with the promotion of renewable energy sources. In this

area of application the mechanical and technological requirements placed on pipe materials as well as the need for security are considerably higher than for pipes used for the distribution of drinking water. Therefore it is imperative that material modifications are developed to meet these increased demands. This report describes the safety concept (the “leak-before-break criterion), the technical material modifications and investigations necessary for practical implementation which will result in better utilisation of ductile cast iron as a material in high-pressure applications and the particular requirements for both crew and piping systems when laying turbine pipelines in alpine environments. All in all a basket of technical goodies!

**Trenchless through the Badrina biotope – enthusiastic visitors follow the pipe pulling-in process at the site open day**

*Uwe Hoffmann and Stephan Hofmann ..... 55*

A dilapidated steel pipeline frequently in need of repair was located in an ecologically sensitive area which has meanwhile been reclassified as an FFH site. In order to avoid further disruptions due to repair work, the old pipeline needed to be replaced without disturbing the biotope and without going in with heavy equipment. Nowadays tasks of this kind are solved very elegantly with ductile iron pipes which are pulled in by means of the single pipe assembly HDD “nonimpact” process.

**Torrent bed-load barrier on the Schnanner Bach**

*Werner Siegele and Christoph Aigner ..... 59*

Ductile iron pipes are the number one choice for hydraulic engineering projects in the Alps, especially when it comes to flood protection. In order to protect a town from flooding after a mudslide a robust arch dam has been constructed which has adjustable openings through which running water containing bed load is accelerated in such a way that boulders and other river debris deposited are washed away, thus preventing conditions which lead to flooding. The adjustable openings, in a so-called inflatable weir system, are filled and activated with water from an elevated tank via ductile cast iron piping systems laid above ground. This calls for a robust piping material which is resistant to impact by rocks and to UV radiation: ductile cast iron!

**Guaranteed snow for the ski jumping hill in Planica**

*Romana Bohm ..... 63*

Planica in Slovenia and Vikersund in Norway are competing fiercely with each other to achieve the greatest flight distance with their ski jumping hills. For World Cup and Championship ski jumping events of this kind, guaranteed snow is an absolute must. And this is where ductile iron pipes come into play for the operation of the snow cannons: the pipes need to be robust, they must be simple and secure to install and they have to withstand very high pressures. Installed above ground, they must be equipped with restrained joints which are easy to assemble. Ductile iron pipe systems have always demonstrated their technical and economic advantages in this field.

**District heating pipeline with water from Lake Geneva in La Tour-de-Peilz (CH)**

*Vincent Voyame and Andreas Schütz ..... 65*

Lake Geneva offers heating energy for its local communities. By means of heat pumps it can be put to good use. The pipelines installed for transporting the water from the lake consist of ductile iron pipe systems which are perfect for the job: they are corrosion-protected inside and out and their large hydraulic cross-section means that operational costs are kept low. Electrically insulating thrust resistance systems prevent the risk of damage due to stray currents and they are easy and safe to install. In short, the ductile iron pipe system meets all the conditions for transporting low-temperature district heating.

**The planning of pre-insulated cast iron pipelines**

*Stephan Hobohm and Karl-Wilhelm Römer ..... 70*

Pre-insulated cast iron pipes can provide ideal solutions for the installation of water pipelines underneath bridges or in traffic tunnels where they are exposed to the risk of freezing. But even water pipelines underground can freeze if they have to be laid with too shallow depth of cover. This article provides a comprehensive summary of all aspects relevant to planning such as calculating the dimensions of the insulation layer, integrating any trace heating which may be necessary and the design of suspension or fixing devices. There are also some valuable advices on the storage, transport and installation of pre-insulated pipes.

## Ductile cast iron creates value

By Ulrich Päßler

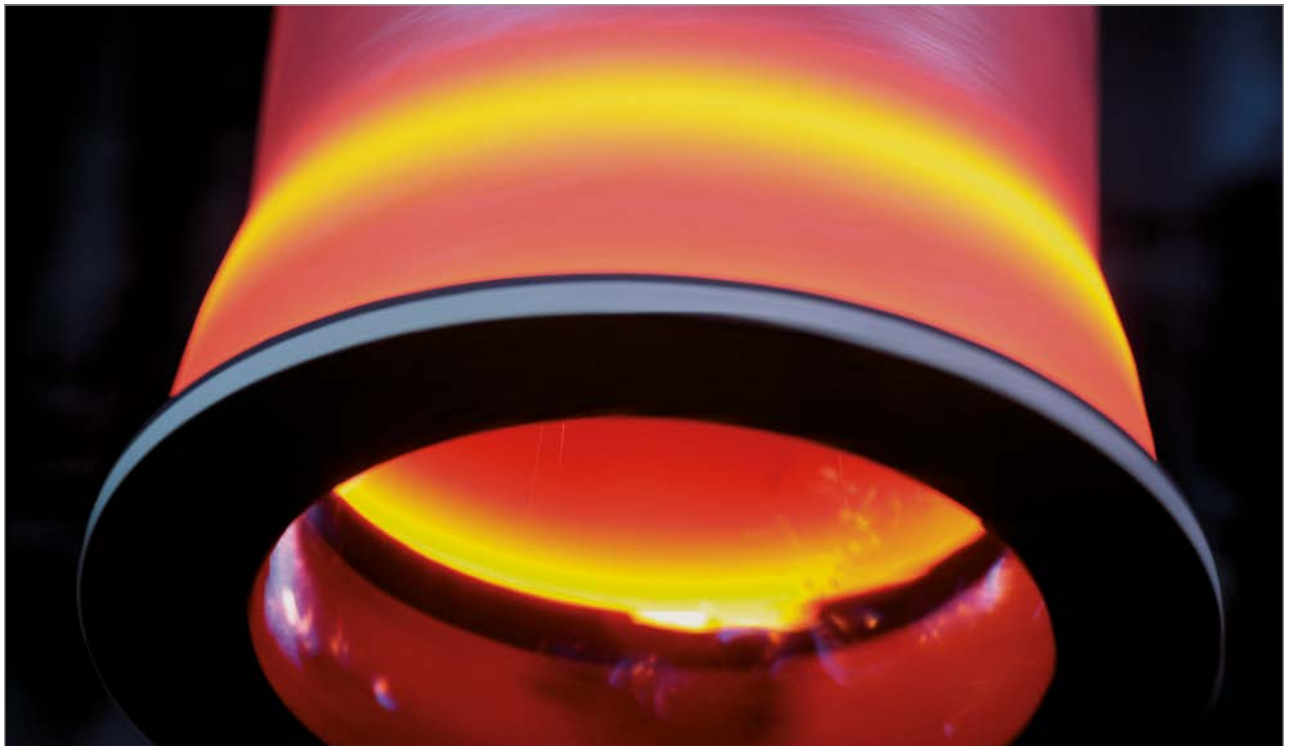

**Figure 1:**  
A ductile iron pipe after production in a centrifugal casting machine [1]

### 1 Introduction

Like no other material for pipes, fittings and valves, ductile cast iron [1] is capable of meeting modern demands for sustainability in water management (**Figure 1**). Sustainability here is understood not only as the use of raw materials, energy and natural resources sparingly and with consideration for the generations to come (ecological sustainability), but also and above all as the long-term saving of financial resources (economic sustainability). The use of budgets in a forward-looking manner is a central managerial task, not just in commercial businesses but also and essentially in the public sector.

In addition, the contribution of products in ductile cast iron for the protection of health and for supplying the population with the drinking water which is essential for life is a further major aspect of a holistic sustainability assessment.

In this article we would like to show how ductile cast iron as a material can bring its sustainable superiority to bear. Ductile cast iron creates value. In so doing, the innovative properties of ductile cast iron as a material and its influence in the various phases of supply and disposal projects in particular play a decisive role.



## 2 Innovative product properties

Ductile cast iron is an innovative material, even though cast iron has in fact been in use since the 15<sup>th</sup> century [2]. Even today, in the gardens of the Palace of Versailles for example and not least in the Wilhelmshöhe mountain park in Kassel declared as a World Heritage site (**Figure 2**) the fountains are operated with pipes in grey cast iron [3]. It is precisely this enormous longevity which nowadays is a significant factor of sustainability. Meanwhile ductility has become a dominating material property of cast iron pipe systems. Its ability to deform flexibly under the pressure of water and external loads gives it lasting stability for use under almost all application conditions. Furthermore, innovations in linings and coatings as well as the development of intelligent joint systems mean that significant economic advantages can be achieved these days in installation, operation, maintenance and rehabilitation. Ductile iron pipes are pretty much predestined for trenchless laying techniques because of their modern characteristics. We shall also be looking into this application here.

## 3 Sustainability across the life span

The most obvious advantages of the use of ductile iron pipe systems can be seen in their installation. The jointing technology using push-in joints allows pipe laying without welding whatever the weather conditions and, if restrained push-in joints are used (**Figure 3**), no thrust blocks are needed for changes in direction [4]. Therefore, as compared with other materials, considerable efficiency advantages and cost savings can be achieved. Added to this is the reduced amount of excavation work because of comparatively shallower cover depths and trench widths. Not to be underestimated is the possibility of dispensing with sand beds when appropriate coatings are used [5]. Cast iron pipes coated with polyurethane and cement mortar (**Figures 4 and 5**) are approved for installation in the pipe trench without any additional sand bedding, thus offering considerable advantages in terms of material and transport costs because the excavation material can be reused.

Because of the low degree of roughness of the lining, only very slight pressure losses occur during operation. This means that extremely economic pump configurations are possible.



**Figure 2:** Cast iron piping in operation for the fountains of the UNESCO World Heritage "Wilhelmshöhe" mountain park in the Octagon beneath the Hercules statue [3]

Source: H. Roscher – photographed on 8 April 2010; Hessen Kassel museum landscape

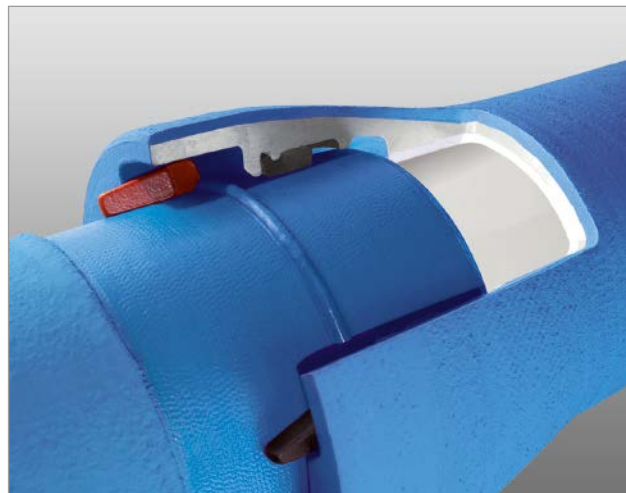

**Figure 3:** BLS®/VRS®-T restrained positive-locking push-in joint [4]



**Figure 4:** Ductile iron pipe with polyurethane coating [5] and lining [6]

The damage rates which are still the lowest for a material for the water management sector guarantee practically damage-free operation [7]. Accordingly, calculations and provisions for repairs and maintenance can be estimated as minimal. Even occasional tasks such as reliable pipe location finding are considerably easier to manage with ductile cast iron products than with other materials.

#### 4 Economic sustainability

If we simply take the advantages outlined above for installation, operation and maintenance and subject them to a plain and simple cost comparison, then some crucial advantages can be calculated as compared with the use of alternative pipe materials [8]. Of course, at first the use of ductile iron pipe systems is associated with higher initial investments per metre of pipeline. However, this additional financial outlay which is often required can generally be recouped in the first year of operation.

In order to ensure such sustainable investments and “create value” on them, corresponding technical planning is necessary which occasionally has to deviate from what may be assumed to be established and superficially more advantageous approaches (**Figure 6**). The community of ductile iron pipe system manufacturers, organised into the European Association for Ductile Iron Pipe Systems/Fachgemeinschaft Guss-Rohrsysteme e.V. (EADIPS®/FGR®), with its many years of experience, is in a position to provide the operator and those responsible for the budget with the necessary planning support backed by professional consultancy and engineering skills.

#### 5 Ecological sustainability

Not calculated, because they cannot readily be measured, are the ecological and health-related properties of this extraordinary material. Naturally, the linings used meet all the requirements of drinking water legislation and are hygienically harmless. As a metallic material, ductile cast iron is impermeable in contrast to plastics [10]. Fluorinated and chlorinated hydrocarbons cannot permeate the material. Hence ductile cast iron offers the best conditions for a sustainable hygienic and ecological method of operating.

At this point it should be mentioned that practically no primary raw materials are used in the industrial production of ductile cast iron.

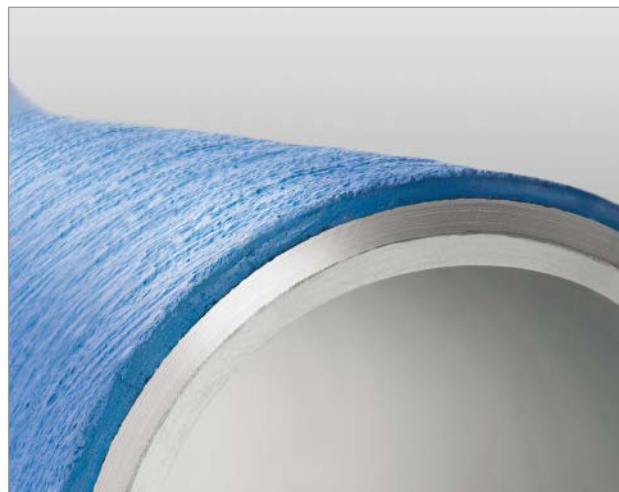

**Figure 5:**  
Ductile iron pipe with cement mortar lining [5] and coating [6]



**Figure 6:**  
Planning and laying of a sea outfall pipe at Binz auf Rügen [9]



**Figure 7:**  
Use of steel scrap for the production of ductile cast iron



**Figure 8:** Snow-making equipment on the ski jumping hill in Planica, Slovenia [11]



**Figure 9:** Directional drilling project on the River Havel in Berlin [12] – DN 700 ductile iron pipes – assembling the traction head – single pipe process

The main raw material for ductile iron pipe systems is recycled material, namely cast iron and steel scrap (**Figure 7**). This means that the end product itself is also almost entirely recyclable. For a consistent consideration of value and sustainability, these material features should be included as well.

## 6 Use for high-performance applications

In addition to the traditional areas of drinking water supply and waste water disposal, the outstanding technical properties of ductile cast iron mean that it can be used for real high-performance applications. So the material is becoming more and more established for use both in

industrial fire-extinguishing systems and in the energy industry as a superior piping system for small and medium-sized hydropower stations. For many years now ductile iron pipes have been indispensable for technical snow-making equipment in ski resorts (**Figure 8**) [11]. Difficult soil conditions as well as height and therefore pressure differences emphasise the advantages of the material in a particularly impressive way.

Another innovative area of use for ductile iron pipes lies in the trenchless laying technique. This should not remain unmentioned here, particularly as regards sustainability aspects.

With the available jointing technologies which allow for the very high tractive forces in the burst-lining, press-pull or horizontal directional drilling (HDD) techniques [12], and with their coatings which can take high mechanical loads, ductile iron pipes are particularly suited to delivering the substantial benefits of these trenchless installation processes (**Figure 9**). Experience has shown that, depending on the project, the trenchless technique can achieve savings of up to 40 % of costs as compared with conventional open trench methods. In addition, CO<sub>2</sub> emissions are reduced. For sustainability-oriented clients, minimising noise and avoiding traffic obstruction caused by pipe-laying work wherever possible is tending more and more to tip the balance in favour of trenchless installation. That too creates value.

## 7 Durability and network management

A unique feature of pipes, fittings and valves in ductile cast iron is their exceptionally long working life. This makes sustainable network management possible.

Unfortunately less than 2 % of the existing public water supply networks are currently being replaced each year in German-speaking countries. With an accepted renewal rate of 1.5 %, an average remaining service life of more than 65 years is assumed – a situation which appears to correspond to the actual case in very few cases in terms of age and materials. Maintaining this investment pattern inevitably results in “value destruction” or what is referred to as a depletion of assets which sooner or later will put the ability to meet public supply obligations at risk. In this respect, when it comes to achieving serious sustainability in network management, not only is more investment needed but above

all it is needed in appropriate materials. Only cast iron pipe systems have an empirically substantiated longevity of more than 100 years and a proven “condition as new” (**Figure 10**) after 25 to 32 years of operation [13], [14], [15]. The systematic use of ductile iron pipe systems within the investment strategy increases the length of the average working life in the networks, meaning that the necessary investment cycles remain economically controllable. Therefore ductile cast iron can create lasting value like no other material in the area of water management. With its closely-knit network of high-performance and highly motivated manufacturers, colleagues and market partners, EADIPS®/FGR® is available to make this potential a reality together with the sustainability-oriented clients in the sector.



**Figure 10:**  
DN 400 ductile iron pipe installed in 1985 – cement mortar coating with epoxy bonding layer and zinc coating – exposed for checking in 2010: no visible corrosion attack [13]

## Bibliography

- [1] E-Book 10.2015  
Download: [www.eadips.org/e-book-e/](http://www.eadips.org/e-book-e/)
- [2] Das Gussrohr –  
Kurze geschichtliche Entwicklung  
[The cast iron pipe –  
Historical development in brief]  
144 (GWF) 1952,  
Issue 10, p. 295–297
- [3] Roscher, H. and Rammelsberg, J.  
DUCTILE IRON PIPE SYSTEMS  
Issue 48 (2014), p. 8 ff.  
Download: [www.eadips.org/journals-e/](http://www.eadips.org/journals-e/)
- [4] E-Book 10.2015, chapter 9  
Download: [www.eadips.org/e-book-e/](http://www.eadips.org/e-book-e/)
- [5] E-Book 10.2015, chapter 14  
Download: [www.eadips.org/e-book-e/](http://www.eadips.org/e-book-e/)
- [6] E-Book 10.2015, chapter 15  
Download: [www.eadips.org/e-book-e/](http://www.eadips.org/e-book-e/)
- [7] Niehues, B.  
DVGW-Schadensstatistik Wasser  
[DVGW damage statistics for water]  
DVGW energie | wasser-praxis 10  
2006, p. 18–23
- [8] Wegener, T. and Böge, M.  
GUSSROHR-TECHNIK  
[CAST IRON PIPE TECHNOLOGY]  
Issue 41 (2007), p. 45 ff.  
Download: [www.eadips.org/jahreshefte-d/](http://www.eadips.org/jahreshefte-d/)
- [9] Opfermann, B. and Rammelsberg, J.  
GUSSROHR-TECHNIK  
[CAST IRON PIPE TECHNOLOGY]  
Issue 43 (2009), p. 16 ff.  
Download: [www.eadips.org/jahreshefte-d/](http://www.eadips.org/jahreshefte-d/)
- [10] Ministerium für Ernährung, Land-  
wirtschaft, Umwelt und Forsten des Landes  
Baden-Württemberg  
[Baden-Württemberg Ministry for Food,  
Agriculture, Environment and Forestry]  
Issue 15, 1984-12, Reprint 1986-12
- [11] Bohm, R.  
DUCTILE IRON PIPE SYSTEMS  
Issue 50 (2016), p. 67 ff.  
Download: [www.eadips.org/journals-e/](http://www.eadips.org/journals-e/)
- [12] Rau, L.  
DUCTILE IRON PIPE SYSTEMS  
Issue 46 (2012), p. 59 ff.  
Download: [www.eadips.org/journals-e/](http://www.eadips.org/journals-e/)
- [13] Rink, W.  
DUCTILE IRON PIPE SYSTEMS  
Issue 45 (2011), p. 25 ff.  
Download: [www.eadips.org/journals-e/](http://www.eadips.org/journals-e/)
- [14] Fachgemeinschaft Gusseiserne Rohre  
Cologne, 1954
- [15] SGK (Schweizerische Gesellschaft für  
Korrosionsschutz)  
Unpublished report 07'044-2 –  
ECOPUR-Rohre in der Grossmannstraße  
[ECOPUR-pipes in Grossmannstraße]  
Zurich, 2007-07-27

## Author

Ulrich Päßler Dipl.-Kfm., M.B.A. (INSEAD)  
Former Chairman of the Board  
of EADIPS®/FGR®  
European Association for  
Ductile Iron Pipe Systems · EADIPS®/  
Fachgemeinschaft Guss-Rohrsysteme (FGR®) e.V.  
Im Leuschnerpark 4  
64347 Griesheim/Germany  
Phone: +49 (0)6155/605-225  
E-mail: [ulrich.paessler@t-online.de](mailto:ulrich.paessler@t-online.de)

## The story of drinking water systems through the centuries

By Jürgen Rammelsberg

### 1 Introduction

It is undisputed that having sufficient drinking water is the most important prerequisite for the development of civil society. There is an impressive account which tells of the technical expertise, the organisational skills and the setting of standards for the supply of drinking water in Ancient Rome [1]. Frontinus was the first Water Commissioner for Rome and he documented his experiences for posterity.

The water transport pipelines of the time were aqueducts, magnificent structures which carried water from distant sources to the main cities by gravity. But during this phase they did not simply construct the technical infrastructure of water supply; they also set up the legal and financial principles, technical standards and management methods without which a secure water supply cannot function. Later on, however, it was above all the royal houses of the Baroque period who, seeking to outperform each other with the fountains in their palace gardens, were responsible for the invention of pressure pipelines. Here are a few landmarks in this development process:

- 1412:** The first known water pipeline using cast iron pipes in Augsburg/Germany
- 1455:** Cast-iron water pipeline to Dillenburg Castle/Germany (**Figure 1**)
- 1680:** Cast-iron flanged pipes in the gardens of the Palace of Versailles/France
- 1700:** Fountains with artificial cascades in Kassel-Wilhelmshöhe/Germany, a UNESCO World Heritage site since 2013
- 1840:** 1.8 km long cast-iron pipeline from the pumping house on the River Havel to the Ruinenberg in Potsdam for the fountains in Sanssouci Park



**Figure 1:**  
Cast iron pipe from Dillenburg Castle (1455)



**Figure 2:**  
Production of cast iron pipes with casting carousels (around 1900)

### 2 The industrial production of cast-iron pipe systems

With the Industrial Revolution in the middle of the 18th century it became possible to generate energy by means of steam engines. At the same time this phase was characterised by dramatic scientific progress.

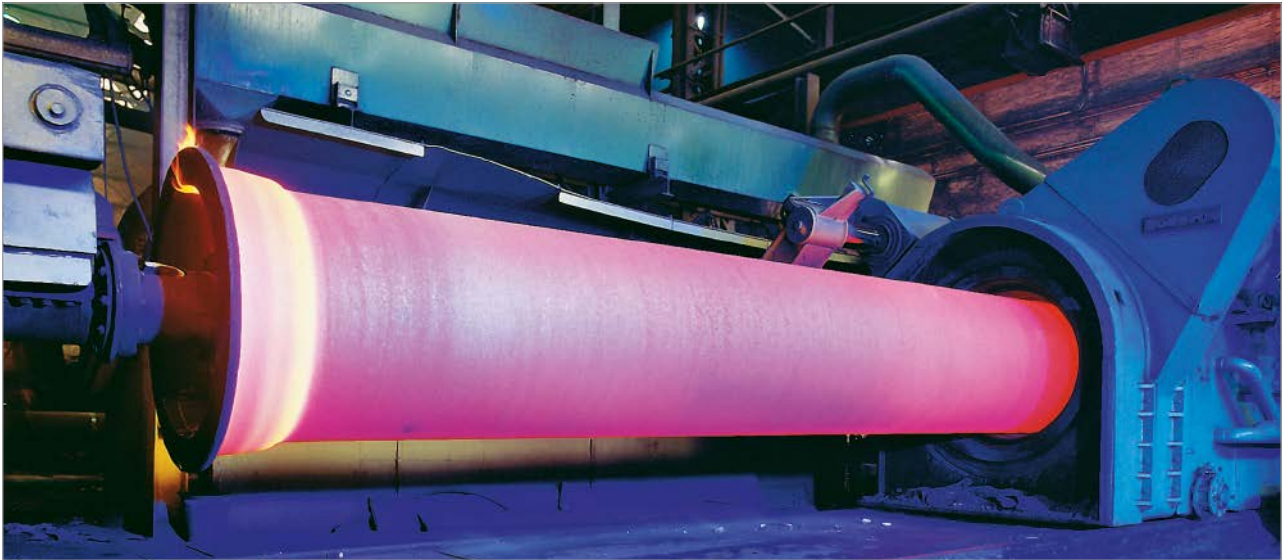

**Figure 3:**  
Production of a centrifugally cast iron pipe using the de Lavaud process

Primarily, progress in medicine and general hygiene resulted in an exponential increase in population figures. A basic element of this progress was the expansion of the supply of drinking water to towns and cities.

The time-consuming production of individual drinking water pipes using the sand moulding technique was replaced by production in vertically arranged casting carousels which were capable of being mechanised and thus made it possible to produce the quantities required for the first time (**Figure 2**). A further acceleration in the production of cast iron pipes was introduced in **1923** with the development of the centrifugal casting process. Even today, almost all cast iron pipes worldwide are still produced using the de Lavaud process (**Figure 3**).

### 3 Development of joint technology

Just as the production technique for pipes had to adapt to increasing requirements over the centuries, joint technology also underwent continuous development. Ancient and mediaeval pipes in stone, vitrified clay, lead and finally also cast iron had socket-shaped ends and were sealed with putty. Flanged joints came along for higher pressures. Sockets stopped with tarred hempen rope and sealed with lead are still in operation today.

It was only with the invention of vulcanised rubber that the important step was taken for the modern pipe joint: it was now flexible and hence could be bent and longitudinally adjusted

in order to adapt to earth movement and subsidence. The “union” screw-gland socket joint was a quantum leap forwards in the 1930’s for the construction of pressure pipelines for water and gas, replacing the decades-old practice of caulking packed sockets with lead.

In the fifties the assembly of joints was once again simplified by the introduction of the “TYTON®” (**Figure 4**) and “Standard” type push-in joint. These constructions are designed in such a way that tightness is achieved by simply pushing the spigot end into the socket which is fitted with a gasket and this can be loaded up to the bursting pressure of the pipe while retaining its flexibility over a useful life of 100 years; so far, 60 years of this have actually been proved in practice.

We will look at the further development of this joint – the restrained socket joint – later in the description of trenchless installation techniques.

### 4 Material developments

The material which has accompanied mankind since the Iron Age is cast iron or, more precisely, grey cast iron or even lamellar graphite cast iron. It is primarily produced by the smelting of iron ore in furnaces, but what is more significant is its production from recycled scrap metal (steel scrap, cast iron scrap, old cars, etc.) in cupola furnaces. The mechanical properties of this material essentially depend on the type of structure and form of the graphite.

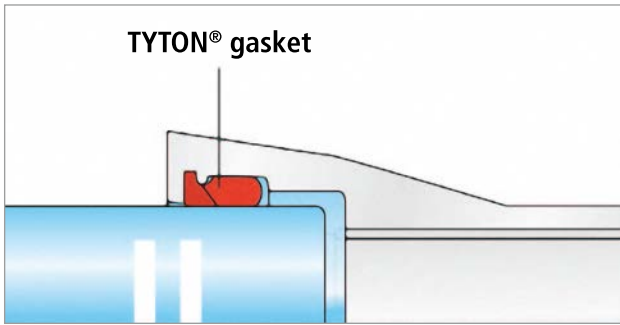

**Figure 4:**  
TYTON® push-in joint



**Figure 5:**  
Ductility – practical implications in the example of longitudinal bending strength

The discovery of spheroidal graphite cast iron and its application in the area of pressure pipelines in the nineteen fifties was epoch-making in character. With this material the elementary carbon is embedded into the matrix in the form of graphite nodules, giving it plasticity and deformability. When it is used for pipes, fittings and accessories the material is referred to as ductile cast iron in accordance with EN 545 [2]. When used in valve bodies then, as is customary in mechanical engineering, it is called spheroidal graphite cast iron, the properties of which are determined in standard EN 1563 [3]. Both standards are used by various technical standardisation committees.

The practical consequences for the loading capacity of pipes, e.g. for longitudinal bending strength, are shown in **Figure 5**. This clearly illustrates the fundamental importance of replacing the traditional, brittle grey cast iron pipe by the ductile iron pipe system for pipeline construction in the fifties.

## 5 Development of the protection system

In the presence of water and oxygen, the oxides and hydroxides of iron are more thermodynamically stable than elementary iron. It corrodes. The consequence of this, when attacked from the outside, is corrosion damage and even perforation; in case of contact with drinking water on the inside this has a negative effect including brown discoloration of the water. Corrosion protection is therefore one of the main tasks in the production of cast iron pipes. The following landmarks highlight developments in this area:

- 1960:** External protection with zinc and bituminous finishing layer
- 1966:** Tar inside and outside (draft DIN 28600 [4])
- 1970:** Cement mortar lining
- 1995:** External protection with zinc and synthetic resin finishing layer (epoxy or polyurethane)

The important feature of the finishing layer is its porosity; this ensures that the soil electrolyte comes into contact with the underlying zinc.

In these cases the metallic zinc reacts with the soil electrolyte and forms insoluble zinc salts which seal both the pores of the cover coating and points of damage. The electrical resistance between the metal, first the zinc and later the iron, and the soil electrolyte increases as the corrosion current decreases.

The indispensable basic condition for the process happening as described is the precipitation of the insoluble zinc reaction product onto the boundary surface between pipe and soil electrolyte. For this the pH value of the soil electrolyte must not be below  $\text{pH} = 6$ . In acid soils (bog, marshland, peat) the protection mechanism does not work. Equally, no lasting protection is possible in an alkaline medium ( $\text{pH} \geq 8.5$ ) because the zinc salts go into solution as zincate in alkaline electrolytes.

A particularly successful development in this area is cement mortar coating in accordance with EN 15542 [5] (**Figure 6**). This has a certain degree of porosity through which the underlying zinc coating interacts with the soil electrolyte. With a coating thickness of 5 mm, the resistance of the coating increases as the result of a progressive hydration of the cement over time. The cement mortar coating is structurally reinforced by inert fibres and therefore

resists enormous mechanical loads, whether during trenchless installation in difficult soils or when laying pipes in open trenches where large-grained or rocky excavation material may in fact be directly reused. Therefore cement mortar coating is extremely appropriate for use in soils of all kinds. Inspections of pipelines after more than 30 years of use in aggressive soils have shown an iron surface which looks as good as new without any attack [6].

While in the past tar and bitumen paints were used for the protection of fittings and valves, the state of the art today is characterised by epoxy resin and enamel. Both types of protection are so-called barrier layers with a high specific coating resistance; they are applied in layer thicknesses which result in a largely pore-free surface.

The epoxy coating is applied by fusing an epoxy powder to the freshly blasted and heated surface of the fitting or body. In the liquid phase, polymerisation reactions take place which produce a highly resistant and closed protective layer. The minimum coating thickness is 250 µm; additional requirements and test methods are described in EN 14901 [7]. The epoxy coating can be used in soils of all kinds.

The modern method of complete enamelling of fittings and valves has developed with the help of recent knowledge about silicate technology from the old craft of enamelling cast-iron ovens. As an inorganic lining for fittings and valves it is very popular in the area of drinking water supply. Requirements and test methods can be found in DIN 51178 [8] (**Figure 7**).



**Figure 6:**  
DN 600 ductile iron pipes with cement mortar coating



**Figure 7:**  
Butterfly valve enamelled on the inside and coated with fusion bonded epoxy powder on the outside

## 6 Restrained push-in joints

The push-in joints described earlier do not absorb any longitudinal forces which occur in changes of direction or cross-section, junctions or dead ends. These forces must be transmitted into the subsoil via suitable thrust blocks, usually in concrete. With large nominal sizes and pipelines outside urban areas, this continues to be the practice on the basis of DVGW worksheet GW 310 [9].

An important alternative to this is offered by the use of restrained joints, but their technical differentiation goes beyond the scope of this historical summary. Apart from a reference to chapter 9 of the EADIPS®/FGR® E-Book [10] which gives comprehensive details, only the landmark features will be listed here.



## 6.1 Friction-locking push-in joints

The longitudinal forces are transmitted by sharp, hardened teeth on retaining elements in the surface of the spigot end.

**1972:** Tyton SIT®

**1985:** Novo SIT®

**1995:** BRS®, TYTON SIT PLUS®

In addition to these constructions, similar solutions have been developed in the various regional markets, usually based on other sealing systems.

## 6.2 Positive-locking push-in joints

The forces are transmitted via formed elements such as welded beads on the spigot ends in combination with force-transmitting elements.

The most important representatives of this class developed between 1975 and 1985 are

- TIS-K,
- BLS®/VRS®-T and BLS® (**Figure 8**).

With the ever improving distribution of forces between socket and spigot end it has in fact become possible to load the joints up to the bursting pressure of the pipes. This has had effects in two major directions: on the one hand in the area of high-pressure applications, such as turbine pipelines for hydroelectric power stations and snow-making equipment in the mountains. However, the second direction triggered a major expansion in construction technology as from the 1990's, namely that of trenchless installation and renewal techniques.

## 7 Trenchless installation and renewal techniques

With the efficient positive-locking push-in joints described in Section 6, the conditions are right for installing and replacing ductile iron pipelines using trenchless techniques. An unprecedented development of trenchless pipe-laying processes began in the early nineties; full details of this can be found in chapter 22 of the EADIPS®/FGR® E-Book [11].

The following milestones in development are mentioned here:

**1993:** Horizontal directional drilling technique (**Figure 9**)

**1990:** Pipe pulling technique

**1999:** Auxiliary pipe technique

The last two techniques mentioned are practised by Berliner Wasserbetriebe with new pipes in ductile cast iron. In Berlin alone around 10,000 m of pipelines in nominal sizes of DN 80 to DN 500 are replaced in this way each year. A further development allows a considerable increase in nominal size if the excess soil is removed in this process.

**1999:** Pulling-in with the rocket plough process

The process uses a height-adjustable plough with which a pre-assembled pipe string is pulled into a new pipeline route. The application is limited to rural areas where there are no underground structures to be found as yet. Ductile iron pipes with robust cement mortar coating have proved themselves in particular in soils with large, sharp-edged stones.

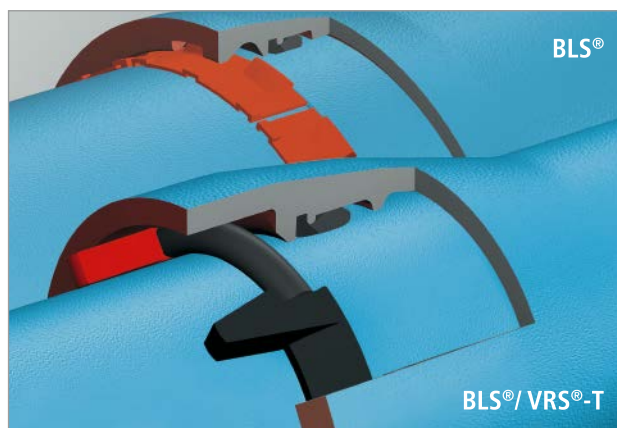

**Figure 8:** BLS®/VRS®-T® ( $\leq$  DN 500) and BLS® ( $\geq$  DN 600) restrained push-in joint



**Figure 9:** DN 900 installation with the HDD technique in Valencia, 2007

### 2003: Static burst lining

Here again the new pipe is pulled in along the same route but in this case the old pipeline remains in the soil, either in the form of fragments or as a cut and opened-up pipe string. During the pulling-in process the new pipes can be dragged along on the sharp-edged fragments which is why materials which are extremely robust and resistant to notching are needed for them. Ductile iron pipes with cement mortar coating to EN 15542 [5] have proved to be excellent in numerous types of applications.

### 2003: Pipe relining

With this technique, new pipes are pulled or pushed into the unaltered old pipeline, whereby the free cross-section of the pipeline is downsized; however, against the background of reduced water consumption levels, this is often welcome as it means that flow speeds can be increased again (**Figure 10**). The technique has become a very popular one and has proved itself in more than 10,000 m total length.



**Figure 10:**  
Pipe relining with DN 800 pipes

## 8 Development of wall thicknesses

When the first ductile iron pipes were produced in the mid-fifties, safety characteristics were at first still limited to thick-walled grey cast iron pipes. After some initial practical experiences, in 1961 the FGR established a standard for the association with Preliminary Conditions of Supply. Then, because the DVGW had conducted a scientific investigation (the “Wellinger study”) to establish assessment bases with load assumptions taken from pipe bedding conditions, one year later it was possible to develop the first DIN standards – DIN 28600 [4] and DIN 28610 [12] – which were published as white papers two years later.

Nominal wall thicknesses  $S_0$  were determined taking account of the permissible circumferential stresses in the pipe wall using the formula

$$S_0 = 5 + 0.01 \cdot DN \text{ [mm]} \quad (1)$$

in wall thickness range K 10.

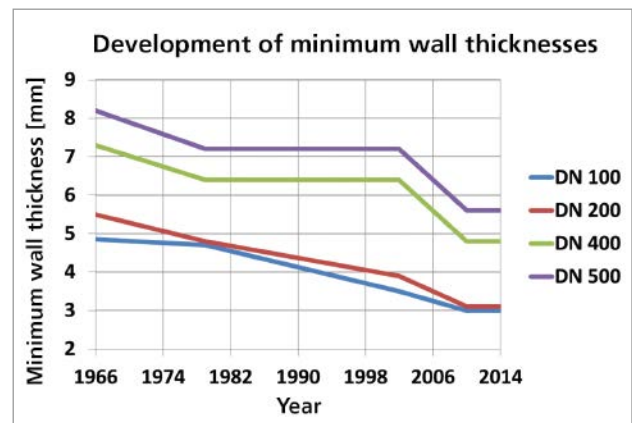

**Figure 11:**  
Development of minimum wall thicknesses from 1966 to the present day

In 1979 international standard ISO 2531 [13] showed a way in which smaller wall thicknesses could be coherently represented in their own wall thickness classes:

$$s = K \cdot (0.5 + 0.001 \cdot DN) \text{ [mm]} \quad (2)$$

where K is to be selected from a series of whole numbers ... 8, 9, 10, 11, 12 ... As early as 1976, because of the possibility of also standardising thinner-walled pipes, the DVGW expert committee on “pipes and pipe joints” asked the FGR to revise standard DIN 28600 [4]. The aim was to introduce wall thickness classes K 9 and K 8 in 1980.

With the development of the first European product standard EN 545 in 1995, wall thickness classes K 8 to K 10 were adopted as standard wall thicknesses.

The accurate production of the smaller wall thicknesses in the centrifugal casting process has matured in the five decades since the advent of ductile iron pipes due to improved machine control and continuous process optimisation. So it was only logical that the cast iron pipe industry would contribute to the trend of adapting water supply components to the prevailing pressures, as is made clear in EN 14801 "Conditions for pressure classification of products for water and wastewater pipelines" [14]. By 2002, in its edition current at the time, EN 545 was listing pressure class C 40 in addition to the K classes still in existence and by 2010 standard EN 545 [2] now only contains pressure classes. A look at the development of minimum wall thicknesses during the last half of the century in **Figure 11** shows that they have almost halved since the introduction of ductile iron pipes.

In parallel to these improvements in terms of production technology, under the pressure of economic demands the trenchless installation techniques were also developing, for which restrained joints almost exclusively are used. The positive locking versions with their welded bead on the spigot end put an end to further development towards thinner walls: for perfect penetration of the weld bead, the welding process requires a wall thickness which should be between 5 mm and 6 mm at least.

Also the multiaxial stress states in a pipe wall which, in addition to the circumferential stress from internal pressure, must also absorb additional axial stresses, bring about a clear reduction in the allowable operating pressure PFA as compared with the non-restrained design. Stating the pressure class C as a synonym for the allowable operating pressure PFA is thus no longer adequate for pipelines operating with restrained joints. Each manufacturer must therefore state the lower value for the PFA for his restrained joints. EADIPS®/FGR® has taken this requirement into account in that it has published its own marking standard, EADIPS®/FGR®-STANDARD 75 [15].

## 9 Conclusion

With this article which we are presenting on the occasion of the 50th anniversary edition of the EADIPS®/FGR® annual journal we hope to show how "cast iron" as a traditional material which has had such a great influence on water supply systems for half a millennium has managed to stay forever young by means of a constant flow of improvements, optimisations and innovations. In so doing, and in collaboration with its users, the cast iron pipe industry has succeeded in always keeping a modern and sustainable pipe system, consisting of pipes, fittings and valves, up to the latest state of the art.

## Bibliography

- [1] Frontinusgesellschaft e.V., Munich 2013
- [2] EN 545: 2010
- [3] EN 1563: 2012
- [4] Draft DIN 28600: 1966-04
- [5] EN 15542: 2008
- [6] Rink, W.  
DUCTILE IRON PIPE SYSTEMS  
Issue 45 (2011), p. 25 ff.  
Download: [www.eadips.org/journals-e/](http://www.eadips.org/journals-e/)
- [7] EN 14901: 2014
- [8] DIN 51178: 2009-10
- [9] DVGW worksheet GW 310: 2009-01
- [10] EADIPS®/FGR®-E-Book, chapter 9  
Download: [www.eadips.org/e-book-e/](http://www.eadips.org/e-book-e/)
- [11] EADIPS®/FGR®-E-Book, chapter 22  
Download: [www.eadips.org/e-book-e/](http://www.eadips.org/e-book-e/)
- [12] Draft DIN 28610: 1966-04
- [13] ISO 2531: 1979
- [14] EN 14801: 2006
- [15] EADIPS®/FGR® STANDARD 75: 2013-06

## Author

Dr.-Ing. Jürgen Rammelsberg  
European Association for  
Ductile Iron Pipe Systems · EADIPS®/  
Fachgemeinschaft Guss-Rohrsysteme (FGR®) e.V.  
Im Leuschnerpark 4  
64347 Griesheim/Germany  
Phone: +49 (0)6155/605-225  
E-mail: [rammelsberg@arcor.de](mailto:rammelsberg@arcor.de)

## Quality assurance through modernisation and increased flexibility

By Max Altmannshofer

### 1 Introduction

In the past year the TALIS Group has invested almost three million Euros in the Frischhut foundry in Neumarkt-St. Veit in order to modernize production and make it more flexible and to improve energy conservation, environmental protection and industrial safety. These days, foundries are expected to offer just-in-time deliveries of fittings for water supply (**Figures 1 and 2**) and wastewater disposal. This means that batch sizes (from three to several hundred units) are getting smaller and smaller and also that delivery times are getting shorter and shorter.

### 2 Development

This development presents problems particularly for small and medium-sized foundries because, technically speaking, they are often not up to the task of meeting demands for flexible production and high quality standards at the same time. Also, older plant tends to consume more energy and resources with such production methods.

### 3 Renovation of furnace technology

The foundry, with the help of its parent company, the TALIS group, drew the necessary consequences from this. For just short of three million Euros

- the furnace technology was replaced,
- the charging system and composition hall were renovated,
- an efficient moulding plant extraction was installed and
- modern energy management was introduced.



**Figure 1:** DN 80 flanged spigot coated with epoxy powder in special length L = 800 mm with PN 16 flange and a welded blue, or optional clamp-on black, puddle flange. The flanged spigot is fitted with a branch connection with a 1" internal thread.



**Figure 2:** Epoxy powder coated DN 80 double flanged 90° duckfoot bend with PN 40 flanges and three branch connections each with 2" internal thread



**Figure 3:**  
Ultra-modern five tonne medium frequency furnace

The work required at Neumarkt-St. Veit was finished by the end of October and the heart of the renovation measures – the two ultra-modern 5 tonne medium frequency furnaces (**Figure 3**) from the Otto Junker furnace manufacturer in Simmerath – were able to go into operation on time. The new furnaces replace one 3 tonne, one 5 tonne and two 12 tonne mains frequency furnaces.

After the first tests it became clear that the equipment offered remarkable production flexibility with better quality. With the technology of the new Junker furnaces, which allows magnetic bath movement to be adjusted as required for the subsequent introduction of carburising agents, the process can be corrected at any time. In addition the new furnaces can melt batches of different materials, making flexible production of a wide range of parts possible.

Alongside the production flexibility and process reliability gained, there are also significant energy savings. The medium frequency furnaces represent an important element here; they are considerably more maintenance friendly than the old mains frequency smelting shop was. Maintenance costs are reduced because the furnaces are now emptied every day.

Previously the old furnaces had to be shut down to a certain sump level and kept liquid right through the night, which meant that power was being consumed round the clock. Now heating-up starts automatically and the iron is actually ready by the beginning of the shift.

#### 4 Conclusion

With these investments a major building block has been laid for the future of the foundry in Neumarkt-St. Veit in terms of sustainable production alongside greater production flexibility and reliable quality standards.

#### Author

Max Altmannshofer  
Ludwig FRISCHHUT GmbH und Co. KG  
Franz-Stelzenberger-Straße 9-17  
84347 Pfarrkirchen/Germany  
Phone: +49 (0)8639/9835-0  
E-mail: maltmannshofer@talis-group.com

## The Lusatian metropolis of Cottbus puts its trust in ductile cast iron valves and fittings

By René Pehlke



**Figure 1:**

Dr Lothar Bohm, who works in the Technical Office at LWG, checking the planned connection to the adjacent DN 400 pipeline on the new drinking water junction of the 600 mains pipeline

Source: LWG

### 1 LWG construction projects

In the period from March to July 2015, the “Straße der Jugend” in Cottbus was the scene of some extensive construction work by LWG Lausitzer Wasser GmbH & Co. KG. The company was replacing the DN 80 supply pipelines and junctions to the two DN 600 and DN 400 main grey cast iron pipelines between the ring road and Dresdener Straße. In addition, LWG was replacing a small section of the old DN 600 water mains, which had been repaired in 1945 after being hit by a bomb

using DN 500 steel pipes. These drinking water pipelines supply around 50,000 Cottbus residents in the districts of Spremberger Vorstadt, Sandow, Ströbitz and the city centre from the Cottbus-Sachsendorf waterworks. Hence these pipelines are some of the most important “lifelines” for Cottbus and have been so for more than 85 years.

In the words of Marten Eger, Head of the Technical Department at LWG, these construction measures will secure the supply of drinking water for residents over the coming decades.

## 2 Installation of a new junction

One particular challenge was the installation of a new junction between the parallel running DN 600 and DN 400 grey cast iron drinking water mains pipelines which, one after another, had to be put out of operation for this purpose in two construction stages. By increasing the drinking water feed-in from the Cottbus-Fehrower Weg waterworks in the North, the drinking water supply continued to be guaranteed in sufficient quantity and at the necessary pressure while the work was being carried out.

In addition to DN 600 and DN 400, PN 10 fittings to EN 545 [1], the valves and fittings manufacturer Keulahütte GmbH from Krauschwitz, also supplied DN 600, PN 10 double eccentric butterfly valves to EN 593 [2] and DN 400, PN 10 resilient-seated gate valves to EN 1171 [3] for this project. All fittings and valves are supplied with integral epoxy powder coating in accordance with RAL guideline RAL – GZ 662 [4] from the quality association for heavy-duty corrosion protection of valves and fittings (Figure 1).

## 3 Quality assurance

The manufacturer's approach to quality knows no compromises: it covers the complete and almost unique production cycle from the casting process to machining and coating and finally to assembly of the valves. In addition, open communication and closeness to the client are important influencing factors for ensuring product quality.

## 4 Product characteristics

Double eccentric butterfly valves in ductile cast iron are characterised by the following properties:

### 4.1 Construction features

The bearing of the Krauschwitz manufacturer's valve disk is not in contact with the medium. It consists of composite bearing bushings with a sintered polytetrafluorethylene (PTFE) layer. This technical solution has proved to be extraordinarily good. Hence valves which have been equipped this way since the 1990's are still functioning today without problem.

In the 1990's, valve bearings moved over to the "double eccentric" principle. This enabled wear on the sealing set to be minimised to a considerable extent, particularly when the seal is "released" during the opening of the butterfly valve. This rather inconspicuous innovation was a major milestone in extending the working life of butterfly valves.

### 4.2 Construction material

EN-GJS-400-15 has become popular as a construction material for butterfly valves. This modern cast iron material with its optimum strength and elongation properties is recommended for all applications where dynamic loads are a factor. The combination of a minimum elongation at break of 15 % with a tensile strength of at least 400 N/mm<sup>2</sup> forms the basis of a safety strategy whereby unacceptable overloading can be recognised by visible plastic deformation long before the breaking point is reached.

### 4.3 Corrosion protection with epoxy powder coating

In their choice of corrosion protection, more and more manufacturers and operators are relying on epoxy powder coating – and this includes Keulahütte GmbH. Continuous process and material development has long since enabled this type of protection to assert itself in pipeline construction. However the full potential of this type of protection can only be achieved with all-round coating of the valve parts.

As well as the process and quality parameters of the coating, this so-called "integral corrosion protection" today offers prospects of working life expectations which even a generation ago seemed unachievable with normal expenditure. With a consistent application of this concept the body seat of the butterfly valve is completely coated. There are no more defect-prone breaks in the protective layer which, in the case of a welded nickel-chrome seating surface for example, could produce signs of corrosion. An essential prerequisite for the coating of the valve seat is of course strict observance of all quality parameters. A coating thickness of at least 250 µm is crucial. The valve parts need to be blasted, cleaned, heated and then coated without delay and with the greatest care on all sides in the once-through principle.

This is a mandatory condition for the required properties of fusion bonded epoxy powder coating, such as:

- outstanding adhesive strength,
- technical diffusion resistance of the pore-free coating,
- a defined level of high impact strength (important for harsh operating conditions),
- very good resistance to underrusting of the coating at points of imperfection,
- extremely high resistance to chemicals and simultaneously fitness for contact with drinking water.

In addition, professional repair kits enable points of damage to be touched up with the same type of material.

## 5 Conclusion

A flexible production chain for a manufacturer which is capable of producing all customer-oriented individual parts to a high quality under his own roof is a weighty argument for a customer when making his choice of ductile cast iron valves and fittings.

A sign of confidence in the technical competence of a valve manufacturer is the fact that more and more customers are sourcing the complete package of products, comprising valves, gearing, electric drive and controls, from the same supplier. With the help of close cooperation between valve manufacturer and drive supplier even complicated projects can be handled without problem.

## Bibliography

- [1] EN 545: 2010
- [2] EN 593: 2009+A1:2011
- [3] EN 1171: 2015
- [4] RAL – GZ 662: 2008

## Author

Dipl.-Ing. (FH) René Pehlke  
Keulahütte GmbH  
Geschwister-Scholl-Str. 15  
02957 Krauschwitz/Germany  
Phone: +49 (0)35771/54-404  
E-mail: pehlke@vem-group.com

**The technical performance of ductile iron pipe systems ensures the highest safety and reliability in all areas of the water industry!**



## Numerical simulation & rapid prototyping in the foundry at JMA Hodonín, a VAG-Armaturen GmbH company

By Radim Hnilica

### 1 Introduction

In recent years the pressure for shortening the development and preparation times needed for the introduction of new products has been getting progressively stronger. At the Czech company Jihomoravská armaturka spol. s r.o. (JMA) in Hodonín, a production workshop of VAG-Armaturen GmbH, modern processes for simultaneous engineering, such as casting and solidification simulation as well as rapid prototyping, have been successfully introduced in order to fulfil ever more challenging customer requirements at all stages of development. Product development is prepared entirely by means of 3D construction software, whereby the strength features of the product are controlled using finite element methods (FEM). Once the construction has been approved by the Technical Department there then follows a production feasibility analysis of the casting prototype. At this point the 3D data are modified to match the requirements of the casting technology and the casting and solidification sequence is checked using simulation software. During this process the first draft of the design of the cast part is examined for risks of casting defects and then discussed with the Construction Department. This technology makes it possible to shorten the process of producing a prototype to a maximum of 10 days.

### 2 Numerical simulation

Numerical simulation has been in use in the JMA foundry since 2005. Since then, solidification analysis has become an effective instrument for the optimisation and further development of castings. This software is an inherent part of the rapid prototyping

technology package. First of all the input parameters had to be validated so that the parameters selected corresponded to conditions at the foundry (**Figure 1**).

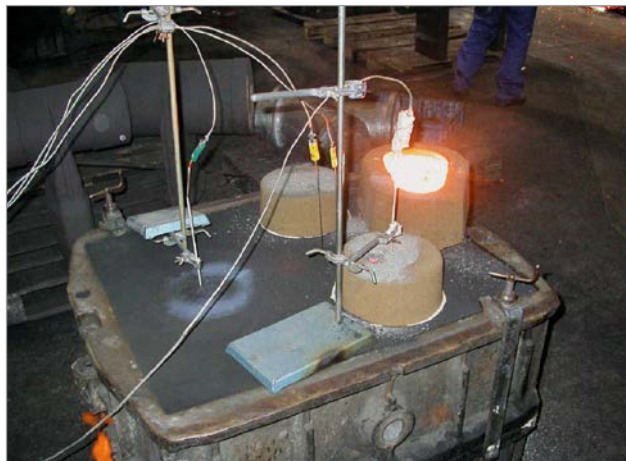

**Figure 1:**  
Validating the simulation parameters

The foundry produces grey cast iron and ductile cast iron using the green sand process. JMA has a large database of materials and their measurement values available which have been collected in the foundry over the many years of use of numerical simulation. Today simulation is primarily an instrument used for the rapid detection of defects in the product development phase. In order to arrive at useable results as quickly as possible, the 3D data and data from standardised casting systems, filters and feeders are brought together.

Working together with the Construction Department, the cast parts are optimised right from the design stage by means of numerical simulation (**Figure 2**). This happens in a combination of different types of software in the following stages:

- modelling the primary construction draft in the Autodesk Inventor 3D system,
- checking by means of strength calculations,
- verification with the software for solidification analysis; search for internal defects.

As the foundry produces around 95 % of its valves with a wall thickness of approximately 8 mm, it is also necessary to determine any presence of imperfections such as cold laps. After the casting and solidification simulation has been evaluated there is an exchange of ideas about optimisation possibilities for hot spots and casting walls until a compromise is reached between functionality, strength and the design of the casting.

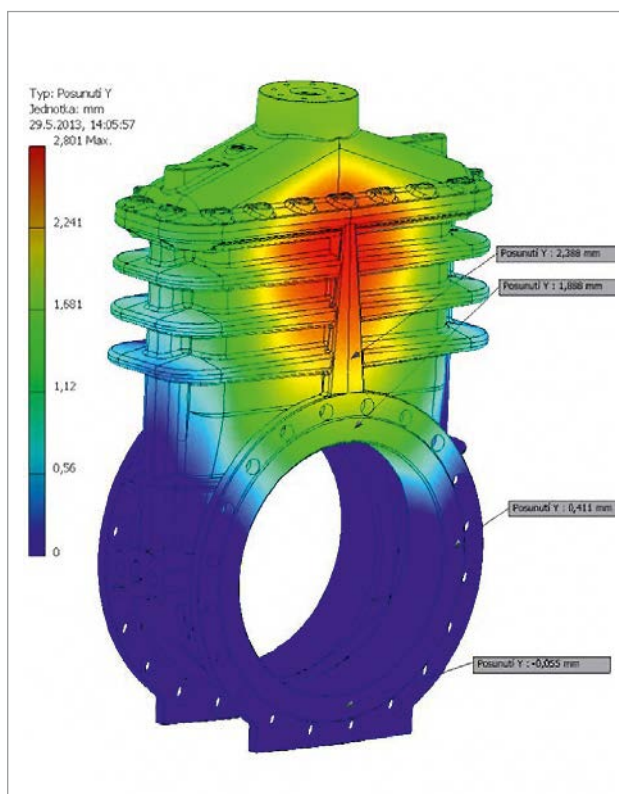

**Figure 2:**  
Results image of a strength analysis

### 3 Development of a control valve

With the use of numerical simulation a number of in-house projects have been developed and numerous simulations have been produced for verifying the drafts. A typical example of the application of the modern rapid prototyping technology is the construction of the VAG PICO® – a pilot-operated control valve (**Figure 3**). First of all the primary data were checked with respect to strength. The first construction was over-dimensioned at certain points.

Then the construction data were verified by means of casting and solidification simulation and individual points were optimised (**Figures 4 and 5**). Using both the software programmes it was possible to reduce the total weight initially calculated by 18 %, which also contributed to the cost effectiveness of this project. After this the drawing documentation was officially released. Then the gating and feeding technique was drafted and verified by means of simulation.

At this stage it was possible to set up the feeder correctly on the basis of a few calculations. The casting system was modified by means of a number of different simulations and designed so that the slight internal porosity occurring inside the cast part on account of the calculations was located at those points where it could not have any influence either on function or on the machining of the castings.

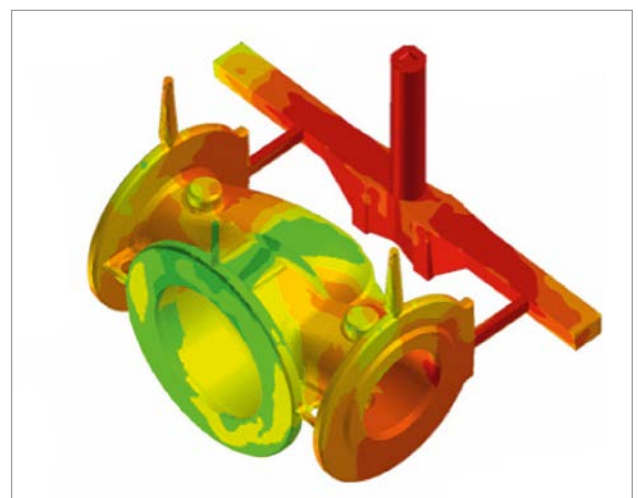

**Figure 3:**  
Solidification simulation – the body of a VAG PICO®

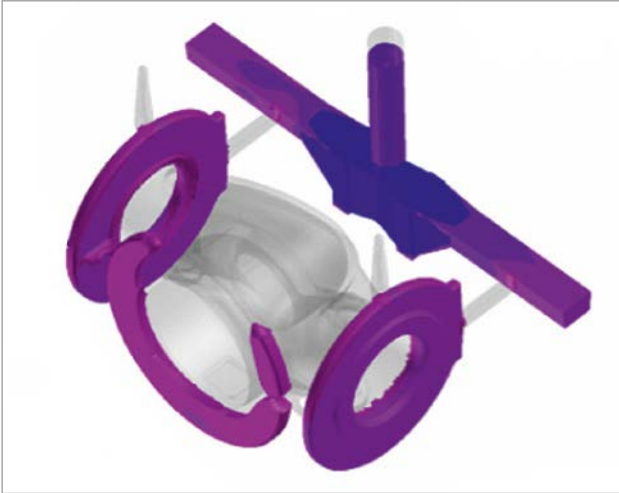

**Figure 4:**  
Result of the solidification simulation before optimisation

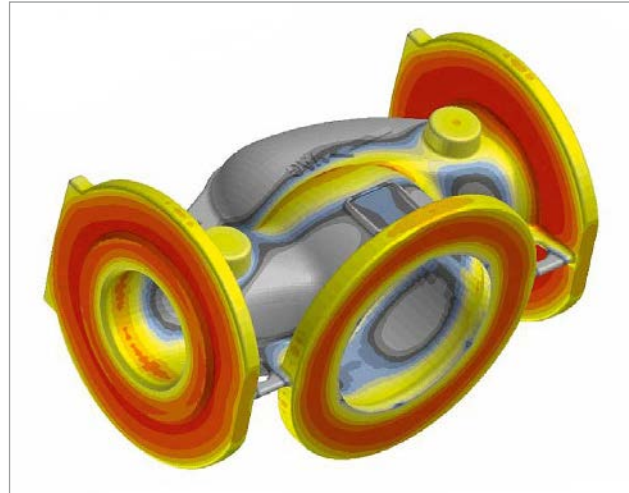

**Figure 5:**  
Image of a solidification simulation after optimisation



**Figure 6:**  
Rapid prototyping by means of 3D printing

**Figure 6** shows another rapid prototyping process, namely 3D printing. Since 2007 a 3D printer with the Poly-Jet technique has been used for rapid prototype development; in this process very thin polymer layers are applied onto a build tray.

Each individual layer is applied with a roller to an even height of 16 µm and hardened with UV light. Once it has hardened the next layer is applied, whereby the build tray travels along the Z-axis. Because of the high precision of printing, the pieces can be divided into a number of parts and these are then very precisely and seamlessly assembled together used prepared fastening elements. In many cases this makes model production faster and more cost effective. The model printout consists of a 3 mm thick shell with stiffening elements. This shell is then cast with considerably cheaper epoxy resin which gives the model sufficient

strength. Because of the high precision of the printing the model does not need any further special processing after printing apart from cleaning. Its surface is so smooth and accurate that the model can be laid on the pattern plate straightaway and formed on an automatic moulding line. This of course means that the development process is very much accelerated. Experience shows that the mechanical properties of the model are sufficient for its use during prototype development. Such a model produced using the 3D printing process did not show any dimensional alterations or mechanical damage at all after more than 600 cycles on the air impact moulding line.

In addition to printing using solid materials, the printer also allows the production of models from rubber-based materials, which are often required above all for seal prototypes. In this case too, the time needed for developing the mould for the production of seals is considerably shortened.

The operation of the printer is very simple and can be compared with the operation of normal office printers. The printer does not require constant operation which means that it is more cost effective than e.g. 5-axis CNC centres. The model for casting the above-mentioned control valve can be produced by 3D printing in just a couple of hours.

**Figure 7** shows that the preparatory work (e.g. preparation of the core model) in parallel with the numerical simulation calculations and core production run in parallel with model printing.

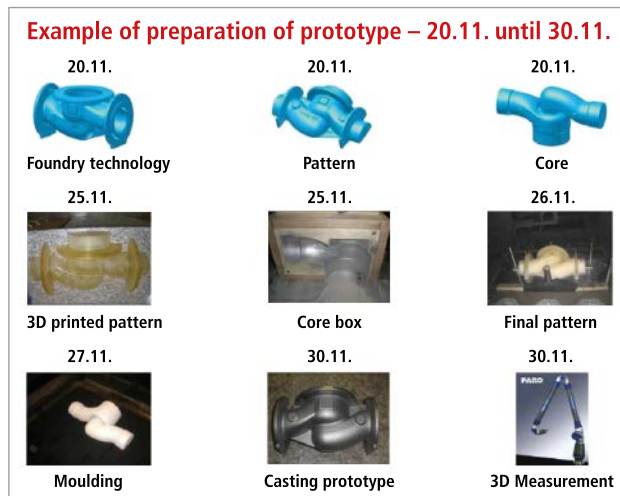

**Figure 7:**  
Model production for the body of the VAG PICO® control valve

The synchronisation of all individual stages has shortened the total casting development time to 2 weeks. After completion of model production in the printer there followed the traditional work of the pattern shop: the production of the core box and laying the model on the pattern plate. Moulding and casting were carried out under standard conditions as required in the simulation.

The sand-blasted cast parts are tested using ultrasound (**Figure 8**).



**Figure 8:**  
Ultrasound testing

At the point where, according to the simulation, the internal porosity had to be, the pattern confirmed the correctness of the calculation. On the inside of the cast part micro-porosity was established but at places where it affects neither function nor the processing of the cast part.

As the last stage of development of the control valve, 3D measurements were carried out. In this way it is possible to check the precision of form and geometry of the cast part on the basis of 3D data very quickly and thus confirm suitability for the subsequent working processes: finishing and assembly. In the JMA foundry, development from the drawing to the finished cast part took 10 days. This short length of time in which the first cast part prototypes can be developed and produced has since been confirmed by other projects.

#### 4 Postscript

Despite some initial scepticism, over the years numerical simulation has become a fixed part of the preparation of cast parts for production in the JMA foundry. However it is above all a fixed part of a number of rapid prototyping processes making it possible to develop new prototypes very quickly and therefore also to react quickly to customer requirements. On account of this simulation these days it is possible to apply the motto: "From drawing to finished casting in 10 days".

#### Author

Radim Hnilica  
Jihomoravská armaturka spol. s r.o. (JMA)  
Lipová alej 3087/1  
69501 Hodonín/Czech Republic  
Phone: +420/518318558  
E-mail: R.Hnilica@vag-group.com

Contact at VAG-Armaturen GmbH  
Michael Krebs  
VAG-Armaturen GmbH Carl-Reuther-Str. 1  
68305 Mannheim/Germany  
Phone: +49 (0)621/749-1929  
E-mail: M.Krebs@vag-group.com

## A milestone in water supply

By René Mattern and Sebastian Ebert

### 1 Drinking water from the groundwater flow of the Aare and Reuss rivers

The municipality of Windisch is in the district of Brugg in the Swiss Canton of Aargau. In the estuary of the Rivers Aare and Reuss, drinking water is drawn from the groundwater stream between the two rivers. Recently, the original reservoir dating back to 1898 has been replaced by the construction of the new Chapf reservoir. The people of Windisch had decided on the new construction back in 2008. The new reservoir with a service water capacity of 2,700 m<sup>3</sup> and an extinguishing water reserve of 300 m<sup>3</sup> replaces the previous facility which had a capacity of 1,900 m<sup>3</sup>. A large number of valves produced by the company ERHARD GmbH & Co. KG have been installed in the new plant.

### 2 Latest technology

A number of aspects were taken into account during the planning and construction of the new Chapf reservoir to make sure that the water supply for the community of Windisch is secured for many years to come. So they decided to provide a reliable extinguishing water reserve in addition to the major



**Figure 1:**  
DN 150, PN 16 gate valves with DN 150, PN 16 nozzle check valves installed upstream

structures. For service water and extinguishing water together, the two reservoir chambers have a total capacity of 3,000 m<sup>3</sup>.

The new staged pumping station was entirely equipped with ERHARD valves, in collaboration with TMH Hagenbucher AG from Zürich. They supplied gate valves in nominal size DN 150 and nozzle check valves in nominal sizes DN 150 (**Figure 1**) to DN 200 as well as butterfly valves in nominal sizes DN 150 to DN 300 (**Figure 2**); in terms of technology and quality, this conforms to the latest state of the art. With these quality valves in the new Chapf reservoir, sustainable operation is guaranteed.

### 3 Selection criteria

The following criteria are crucial when selecting valves:

- Hydraulic design:  
The valves used must be as resistance-free as possible, i.e. have the lowest  $\zeta$  values.
  - The gate valves up to DN 150 create no resistance and are therefore very efficient.
  - The nozzle check valves behind the booster pumps have an extremely low resistance of 0.14 mbar on account of the optimum flow characteristics of the body construction. In addition these valves close faster than the back-pressure produced by the system, which means that unwelcome water hammers are avoided.
  - The same applies to the resistance coefficient of the ROCO wave butterfly valve. Also this product offers the best flow results. The flow resistance coefficient ( $\zeta$  value) has been considerably reduced



**Figure 2:**  
ROCO wave butterfly valves, DN 150, PN 16



**Figure 3:**  
Windisch spinning mill



**Figure 4:**  
Restored tower of the valve chamber

with the new ROCO wave butterfly valve and its wave design disk. Depending on nominal size, a reduction in the resistance coefficient of between 20 % and 40 % is associated with this construction.

- Internal protection:  
All valves which are relevant to the system are enamelled internally.
- Knowhow, engineering, service, after sales, sustainability:  
These five criteria are important in the selection of valves. Manufacturer and specialist dealers meet the requirements of these five criteria. Valves are sustainably designed and, with the correct design, function without problem throughout their entire working life. But spare parts are nevertheless still available even after 30 years of use.

#### 4 A look back over the history

In former times, the Windisch spinning mill (**Figure 3**) operated its own pumping station and reservoir; both were in need of renovation. With the new Chapf reservoir and the pumps installed

in it, the old spinning mill water supply could be abandoned, at the same time reducing costs. While the building work was being carried out on the Chapf reservoir the 112 year old tower of the valve chamber (**Figure 4**) was also restored. The tower was crenelated and placed under a building protection order.

#### Authors

René Mattern  
TMH HAGENBUCHER AG  
Friesstrasse 19  
8050 Zurich/Switzerland  
Phone: +41 (0)44/3064748  
E-mail: info@hagenbucher.ch

Sebastian Ebert  
ERHARD GmbH & Co. KG  
Meeboldstraße 22  
89522 Heidenheim/Germany  
Phone: +49 (0)7321/320-0  
E-mail: info@taligoup.com

# Time saving and flexibility in the installation of hydrants thanks to a new modular system

By Daniel Buri and Andreas Schütz

## 1 Introduction

Demands and requirements for the lower sections of hydrants have been constantly increasing in recent years. In order to meet these requirements, the number of types, versions and options has increased, resulting in a greater degree of complexity for the customer. Water suppliers who use a number of designs have to keep an extensive range of assorted parts in stock, which not only takes up space but also requires financial resources.

## 2 Modular system

With the development of the new VARIO 2.0 range of modular hydrant lower sections (**Figure 1**) the engineers of vonRoll hydro (suisse) ag have consistently worked to develop a product which, with as few components as possible, meets every customer requirement. In addition, each function should be performed just once and with the same components. It was for this reason that the principle of modularity was applied in the design phase: a principle which has already been considered as standard for years in the automobile sector and in mechanical engineering. With the new concept, for example, thanks to the universal valve seat there is the option of using two different types of valve. Also, by putting a cover onto any type of lower section, an underground hydrant is produced. It does not matter here whether the riser pipe is adjustable or of a fixed height. What is more, the bottom parts are mounted directly onto a tee-fitting (with flanged branch), which offers greater freedom of design on installation. The range includes both adjustable riser pipes and ones with a fixed length.



**Figure 1:** Height adjustable VARIO 2.0 hydrant lower section with inlet bend and polymer concrete base

The new system meets all relevant European standards and guidelines [1] to [8] and, just as the previous product did, has all the necessary certificates.

## 3 Universal main valve seat

The new main valve seat has been designed to be modular and universal to the extent that two different sealing systems are used in the bottom part of the hydrant. There is a choice now

between the use of radially and conically sealing valves (**Figure 2**), without having to change any other components. This has the advantage that customers who wish to change over to another type of valve at a later date can use the new valve simply, quickly and without excavation work.

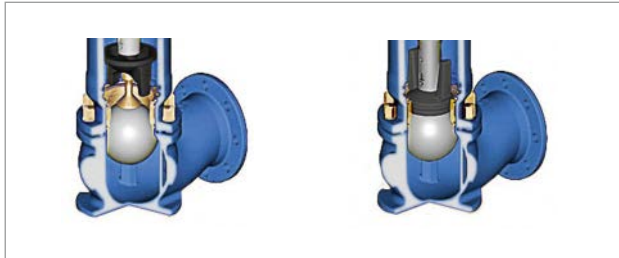

**Figure 2:**  
Conical and radial sealing valves can be used in the same main valve seat



**Figure 3:**  
Extremely simple height adjustment with the patented bayonet system

This type of work is, like any other overhaul process, possible under full mains pressure. Another plus point of the universal valve seat is that it can be dismantled from above, thus meaning that any overhaul work can be carried out from above without involving any excavation work. Thus the lower section can be equipped with a double shut-off ball at any time and without major expense. In addition the hydrant can be quickly drained via the twin-hole drainage system incorporated in the valve seat.

#### 4 Extremely simple height adjustment

Height adjustment is based on the bayonet principle and so simple that it can be operated intuitively and by one person alone (**Figure 3**). After removing the protective cover, two bolts are unscrewed, the telescopic pipe is turned 180° and the height is adjusted. Once the desired height is reached, the telescopic pipe is turned back to its initial position as far as the stop and the height is automatically locked. This means that both hands are free for tightening the bolts again. Customer surveys have shown that in most cases a minimum adjustment range of 10 cm to 20 cm is sufficient. For this reason, as a new standard, the telescopic pipe is supplied with a 25 cm adjustment range in steps of 5 cm. Special lengths are available on request. These and other measures mean that the VARIO 2.0 is around 30 % lighter.



**Figure 4:**  
Preparation before installation: optimum stability on the new polymer concrete base – preassembled connection pipe and cover for the design as an underground hydrant



**Figure 5:**  
The polymer concrete base offers an ideal foundation for the entire hydrant combination – pillar hydrant design



## 5 Complete range right from 25 cm cover depth

Another feature of the concept is that the new tunnel hydrant can already be ordered as from a cover depth of 25 cm. It is also assembled from the standard components of the modular system and can be configured according to customer requirements. This also means that tunnel hydrants are height adjustable, equipped with the universal main valve seat and can be supplied with a double shut-off.

## 6 Time-saving installation

With the new VARIO 2.0 hydrant bottom part, vonRoll hydro is following a new philosophy for installation. Thanks to the optionally available polymer concrete base, all pre-assembly work can be done beside the trench, where all components are still easily accessible. Work in the tight space of the trench is limited to a minimum. This new approach saves both time and costs. The stable base also makes optimum and secure positioning of the bottom part of the hydrant possible even on sloping terrain, leaving both hands free for the necessary adjustments. One person can easily and quickly adjust the height. Once the height has been set, the black rubber protective cover is drawn back over the connection point and protects it against dirt, which considerably simplifies later adjustment. Because of its stable support on the polymer concrete base, new connection pipelines (**Figure 4**) or even stop valves, if possible outside the trench, are quickly and conveniently preassembled and do not have to be laboriously assembled or bolted together in the narrow and inaccessible trench. So outlets for house connections or even the cover for the underground hydrant design (**Figure 4**) can also be preassembled. The polymer concrete base makes positioning and alignment in the trench easier (**Figure 5**). The previous practice of underlaying with paving slabs or wooden wedges is no longer necessary.

## 7 Successful introduction onto the market

The new VARIO 2.0 range was put onto the market in Spring 2014. It replaced five previously available products, both bottom parts and underground hydrants. With the modular principle, the multitude of types of equipment needed by the customer and the storage space which they require could be drastically reduced. In addition, logistics have become significantly simpler, above all for those who obtain individual parts and then assemble the corresponding bottom part themselves in their own stock for a specific project.

Feedback has shown that the new VARIO 2.0 modular hydrant bottom section has met with a great deal of acceptance and has captured the imagination. This is not only due to the modular construction and the ease of height adjustment but also to the new possibilities which the optional polymer concrete base has to offer.

### Bibliography

- [1] DVGW worksheet W 331: 2006-11
- [2] DVGW worksheet W 405: 2008-02
- [3] EN 14384: 2005
- [4] EN 14339: 2005
- [5] EN 1074-6: 2008
- [6] DVGW test specification VP 325: 2008-01
- [7] EN 1074-1: 2000
- [8] DVGW test specification W 386: 2014-09

### Authors

Dipl.-Ing. Daniel Buri  
vonRoll hydro (suisse) ag  
Von Roll-Strasse 24  
4702 Oensingen/Switzerland  
Phone: +41 (0)62/388-1222  
E-mail: daniel.buri@vonroll-hydro.ch

Dipl.-Ing. Andreas Schütz  
vonRoll hydro (suisse) ag  
Von Roll-Strasse 24  
4702 Oensingen/Switzerland  
Phone: +41 (0)62/388-1238  
E-mail: andreas.schuetz@vonroll-hydro.ch

## DN 1200 butterfly valves for Fernwasserversorgung Elbaue-Ostharz GmbH – valve replacement in the raw water tunnel at Wienrode waterworks

By Frank Schmidt and Ursula Ritter

### 1 Introduction

The water supply company Fernwasserversorgung Elbaue-Ostharz GmbH in Torgau operates an approx. 700 km long water transport network and three major waterworks at the locations of Wienrode, Torgau and Mockritz. Every day two million people in Saxony-Anhalt, Saxony and the North-East of Thuringia are supplied with around 209 million litres of drinking water. Roughly half of this comes from the Harz waterworks in Wienrode.

With a capacity of 180,000 m<sup>3</sup>, the Wienrode waterworks is one of the largest in Germany. Raw water from the Rappbode dam reservoir arrives at the waterworks via a 3.2 km long tunnel. Around one million people in Saxony-Anhalt get their drinking water from this reservoir.

### 2 Pipeline replacements

The Harz waterworks was disconnected from the network in November 2014 for the first time since its commissioning 50 years ago. The reason for this action was that it was necessary to inspect the raw water tunnel. At the same time valves were also replaced in the tunnel outlet structure.

Under some extremely tight conditions the existing valves and fittings were broken down into their component parts and removed from the structure using heavy equipment (**Figure 1**).

### 3 Installation of the DN 1200 butterfly valves

Once the old valves had been dismantled, the new ones could be installed. The double eccentric DN 1200, PN 10 butterfly valves, referred

to as type 451 by the valve manufacturer, are coated on the inside and outside with etec enamel. They were installed at the point where the two pipelines emerge from the raw water tunnel (**Figure 2**).



**Figure 1:**  
Dismantling the old existing valves



**Figure 2:**  
Installing the double eccentric, fully enamelled DN 1200, PN 10 butterfly valve

When necessary they cut off the raw water feed into the waterworks. **Figures 3 and 4** show the process of installing the DN 1200, PN 10 butterfly valves coated inside and out with etec enamel. Despite difficult conditions, the work went as planned.



**Figure 3:**  
The DN 1200 flanged spigot and the DN 1200 dismantling joint are made ready as a single unit for assembly with the DN 1200 butterfly valve



**Figure 4:**  
Both flanges of the DN 1200, PN 10 butterfly valve are connected to the existing pipeline components

#### 4 Quality features of etec enamel

Absolute tip-top quality and operational reliability are of fundamental importance for this type of application. The robust and stable construction of double eccentric Düker butterfly valves combined with the outstanding material characteristics of the enamelling meet the high demands for reliability and longevity without compromise. The properties of etec enamel can be summarised as follows:

- etec enamel is inert and diffusion-tight. It is impermeable to gas and tasteless and there is no interaction with the medium.
- etec enamel is as smooth as glass both inside and out. This means that it actively inhibits the growth of biofilm and the adhesion of invisible dirt and it reliably prevents the wearing of elastomers.
- etec enamel is highly corrosion resistant. At the interface of the material the fusion layer between enamel and cast iron prevents any disbonding.
- etec enamel is acid resistant. It has a high resistance level and is therefore suitable for use in soil class III according to DVGW worksheet GW 9 [1] and DIN 50929-3 [2], [3] as well as in aggressive environments.

#### Bibliography

- [1] DVGW worksheet GW 9: 2011-05
- [2] DIN 50929-3: 1985-09
- [3] DIN 50929-3 supplement 1: 2014-11

#### Authors

Frank Schmidt  
Düker GmbH & Co. KGaA Hauptstraße 39-41  
63846 Laufach/Germany  
Phone: +49 (0)151/16889637  
E-mail: frank.schmidt@dueker.de

Ursula Ritter  
Düker GmbH & Co. KGaA Hauptstraße 39-41  
63846 Laufach/Germany  
Phone: +49 (0)6093/87-255  
E-mail: ursula.ritter@dueker.de

## Simple and more reliable house connection system without parts that will get lost

By Andreas Schütz

### 1 Introduction

These days house connections for connecting and disconnecting the water supply have to fulfil a large number of different requirements but, at the same time, they should also continue to be simple and cost-effective for the customer. For example, integral corrosion protection is now a prerequisite and it must reliably prevent corrosion in all soil conditions, thereby ensuring a long working life. It is also expected that operation should be effortless and possible without exerting force even after decades of use. But, in addition to high operating and functional reliability, the system should also be as easy as possible to assemble. Installation must not only be able to be done quickly and easily, it must also and above all be intuitive. Lengthy operating and assembly instructions are out of place in the pipe trench. If special tools are needed for installation it can be difficult to get a new system established on the market. The trend in the field of house connection systems is going towards a major part of the installation being possible without any tools at all. If, in addition, the system comes without parts which can be mislaid – and which are usually hard to find again in the mud and grime of the pipe trench – the system has some great advantages over conventional products.

### 2 Corrosion-protected bayonet connection with patented anti-twist device

With the new CLICK® house connection system (**Figure 1**) a range of reliable connection devices has been developed which are easy and time-saving to assemble and which can be put together in the modular system without tools. The vonRoll CLICK® is a bayonet connection which consists of a bayonet socket, a bayonet

spigot end and a patented anti-twist device. The anti-twist device is preassembled and automatically stops the bayonet connection when it is turned. There is no need for any further securing elements, which are prone to getting lost in the trench. Sealing is by means of a double O-ring seal which has long since proved its value in the valve industry. All components are fully coated with epoxy resin in accordance with RAL – GZ 662 [1] and can be used in soils of any kind.



**Figure 1:** CLICK® house connection system – tapping sleeve with valve tapping device



**Figure 2:**  
Assembling the  
CLICK® connection



**Figure 3:**  
Dismantling the CLICK® connection

### 3 Easy to assemble and dismantle

During assembly the bayonet spigot end is pushed into the bayonet socket and locked by turning it clockwise until the “CLICK” is heard (**Figure 2**). The patented anti-twist device secures the connection from unlocking accidentally. Axial rotation of  $\pm 15^\circ$  ensures optimum flexibility when aligning the valve in the trench. If it needs to be dismantled, the anti-twist protection can be withdrawn slightly at the “PULL” marking while the fitting or valve is simultaneously turned back in the anticlockwise direction to the stop. The fitting or valve can then be removed from the bayonet socket (**Figure 3**).

### 4 Specially suitable for difficult installation conditions

Installations with the new CLICK® range of house connections have aroused a great deal of interest and enthusiasm with clients. This is due above all to their easy and time-saving installation. Once the tapping bridge is mounted on the pipe and tapping has been completed with or without mains pressure, the other components can be fitted very easily without any tools. Because there are no additional small assembly parts which can get lost, the system is also very well suited to difficult installation conditions, for example where there is water and mud in the

trench (**Figure 4**). Plus, during the cold winter months, problem-free assembly is even possible when wearing thick gloves.



**Figure 4:**  
Tapping under mains pressure

### 5 Consistent application of the connection concept

In the implementation of the CLICK® concept for the range of tapping valves, attention has been paid to consistent application of the connection principle. So the same connection principle is also used for the connection between the valve body and the upper section. Hence integral corrosion protection is also achieved in

the area of the connection of the bonnet, which ensures a very long working life. The bonnet can be released and dismantled effortlessly and without tools. This means that exchanging the closing body or other components can be done quickly and easily. If the valve needs to be tapped, the operation is done quickly and without tools. The bonnet is unlocked by means of the CLICK® system (**Figure 5**) without additional tools and manually removed from the housing. The tapping tool is attached with the same bayonet connection and automatically secured by the twisting motion. After the tapping process the tapping tool can be unlocked and removed. Then the bonnet is simply put back again by hand. However, tapping through the valve is something of an exception because ideally this is done through the tapping bridge. In this case too the tapping tool can be put in place and secured directly by means of the CLICK® principle. No additional adapters or other aids are needed.

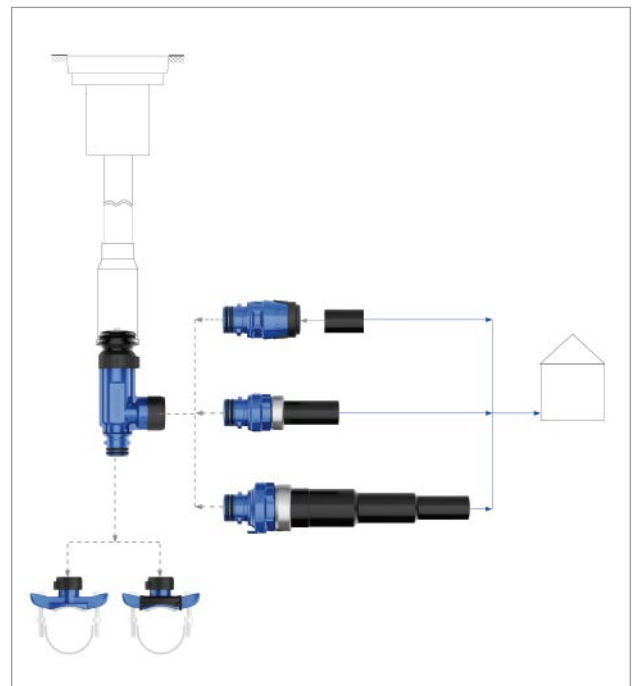

**Figure 5:**  
CLICK® principle - connection of body to bonnet

## 6 Starter range

The range includes three valves which correspond to valve testing standards EN 1074-1 [2] and EN 1074-2 [3]. With the different designs tapping can be done from above (**Figure 6**) or from the side (**Figure 7**). An isolating gate valve design is also available (**Figure 8**).

The tapping bridge is offered in two versions: for tapping under mains pressure with an auxiliary shut-off or for pressureless tapping. The range is completed with two fitting designs: PE plug fitting and PE spigot fitting in each case from DN 25 to DN 50 or dR 32 to dR 63, developed according to the guidelines of DVGW test specification GW 335-B4 [4]. The range of house connections supplements the vonRoll system of valves for drinking water supply. An extension of the range of fittings (**Figure 9**) is planned according to market requirements.



**Figure 6:**  
Tapping from above

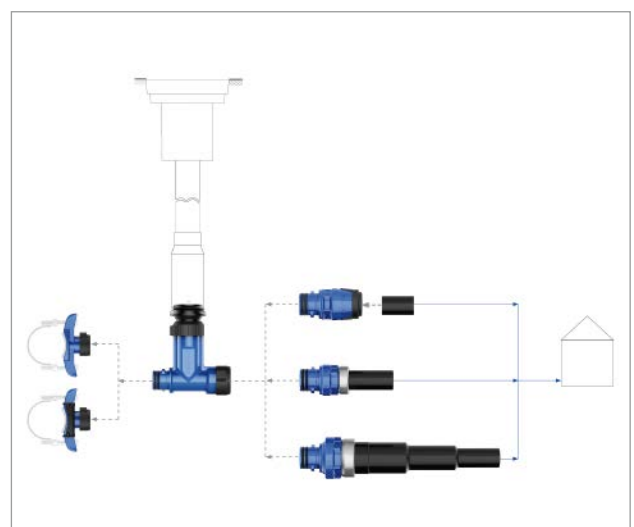

**Figure 7:**  
Tapping from the side

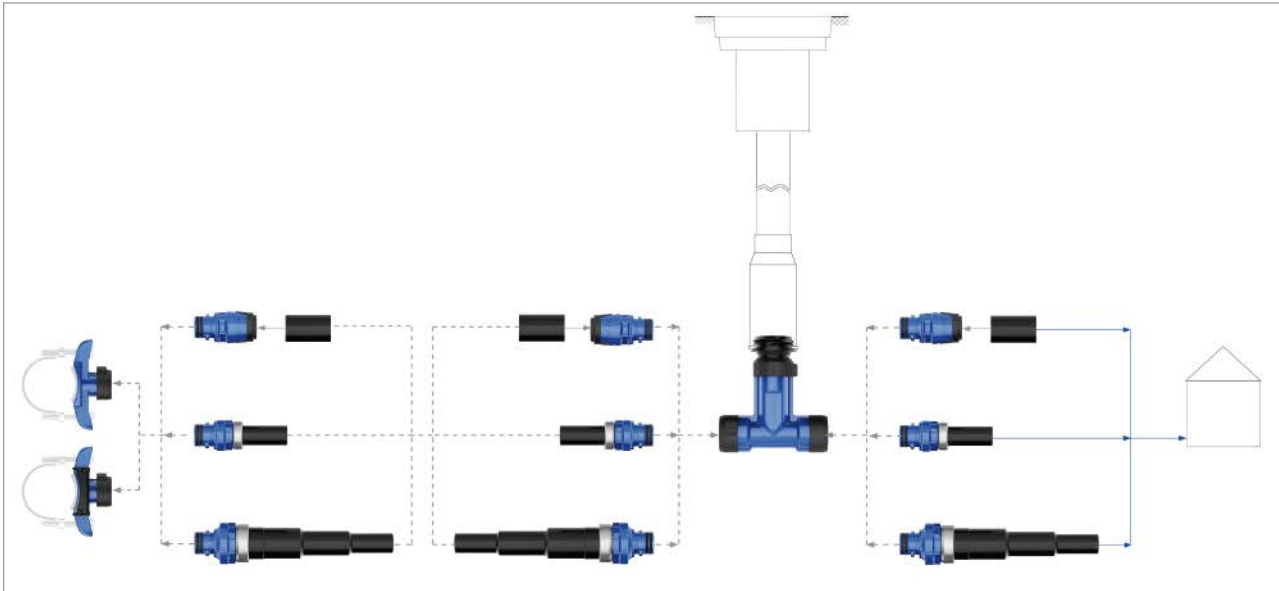

**Figure 8:**  
Isolating gate valve design



**Figure 9:**  
CLICK® starter range

### Bibliography

- [1] RAL – GZ 662: 2008
- [2] EN 1074-1: 2000
- [3] EN 1074-2: 2000+A1:2004
- [4] DVGW test specification  
GW 335-B4: 2014-04

### Author

Dipl.-Ing. Andreas Schütz  
 vonRoll hydro (suisse) ag  
 Von Roll-Strasse 24  
 4702 Oensingen/Switzerland  
 Phone: +41 (0)62/388-1238  
 E-mail: andreas.schuetz@vonroll-hydro.ch

## 7 Conclusion

With the new CLICK® house connection system vonRoll hydro is implementing integral corrosion protection consistently: the area of the bonnet connection has overall protection. The new connection concept is extremely easy to assemble and completely does away with additional, easily-to-lose parts. The functional principle of the connection is so simple and intuitive that no operating or installation instructions are necessary. The range will be continually enhanced.

# The steady renewal of the “Auer Ring” long-distance drinking water system in the Western Ore Mountains in Saxony – an interim report

By André Clauß

## 1 Choice of material

The difficult rocky terrain of the Westerzgebirge, or Western Ore Mountains, with large geodetic height differences demand care in the choice of pipe material. After weighing up all the pros and cons, the Westerzgebirge waterworks association opted for the use of DN 400 ductile iron pipes with restrained push-in joints. In a few particular sections it was planned to use pipes with cement mortar coating. Because of the low buffering capacity of the water and the technically unavoidable stagnation points in a ring pipe system the pipes lined with cement mortar in the factory needed to be conditioned in sections before being put into operation. In this way the possible influences on pH value due to stagnating water are excluded.

## 2 Introduction

The Zweckverband Wasserwerke Westerzgebirge (ZWW) water supply association located in South-West Saxony was formed on 01 April 1993 by 39 towns and communities of the rural district of Aue and Schwarzenberg and entrusted with the tasks of supplying drinking water and wastewater treatment. Currently around 171,500 residents are served by the ZWW. The territory covered by the ZWW is divided into three drinking water and two wastewater supervisory areas (**Figure 1**). At the end of 2013 the rate of connection to the drinking water network was a remarkable 98.9 %. The length of the piping network for drinking water totals 1,717 km. Altogether ZWW has an elevated storage tank capacity of approximately 71,000 m<sup>3</sup>. In 2013 4,554,160 m<sup>3</sup> of drinking water was able to be supplied to ZWW customers.

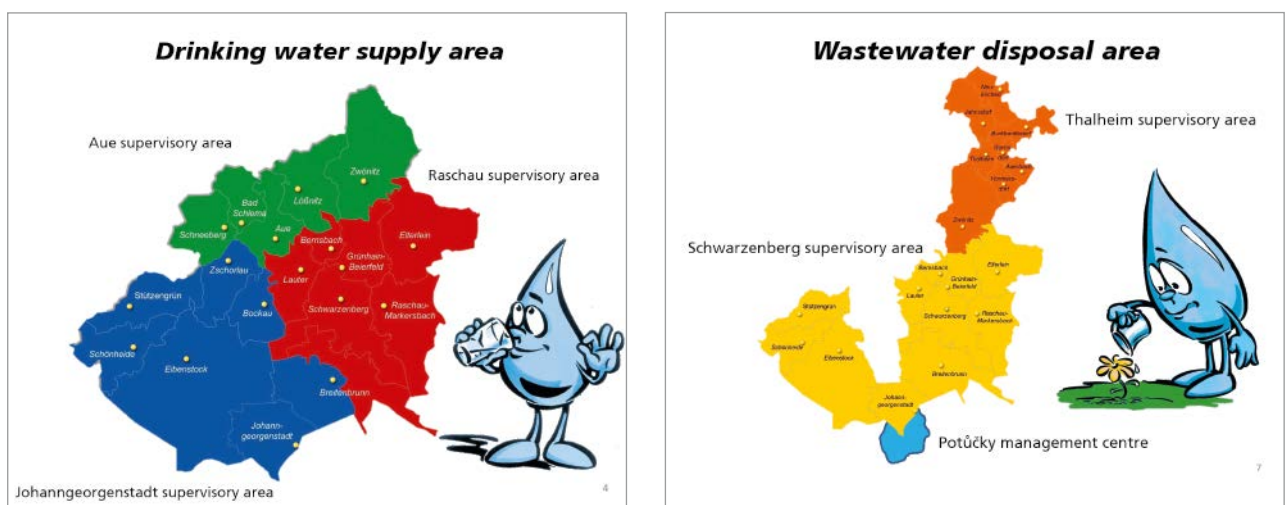

**Figure 1:** Drinking water supply and wastewater disposal area of the Westerzgebirge waterworks association (ZWW)



### 3 Project

The “Auer Ring” long-distance water pipeline system is one of the core elements of the drinking water supply in the Western Ore Mountains region. Ten towns and communities are connected over a total length of around 22 km; they are supplied with purified reservoir water from the Sosa reservoir dam (Figure 2). The long-distance water system was laid in the context of the construction of the Sosa reservoir dam in around 1950. At that time engineers were predominantly using unprotected metallic pipes (grey cast iron or steel) or concrete pipes in dimensions DN 350 to DN 800. The latter were mainly used in the low pressure ranges, in sections located geodetically higher.

Because of the high operating pressures of up to 22 bars in places and also because of the materials used, there were often a number of pipe bursts recorded each year. The DN 450 concrete pipelines in particular proved to be critical. Usually the sockets were leaking or the concrete was corroded.

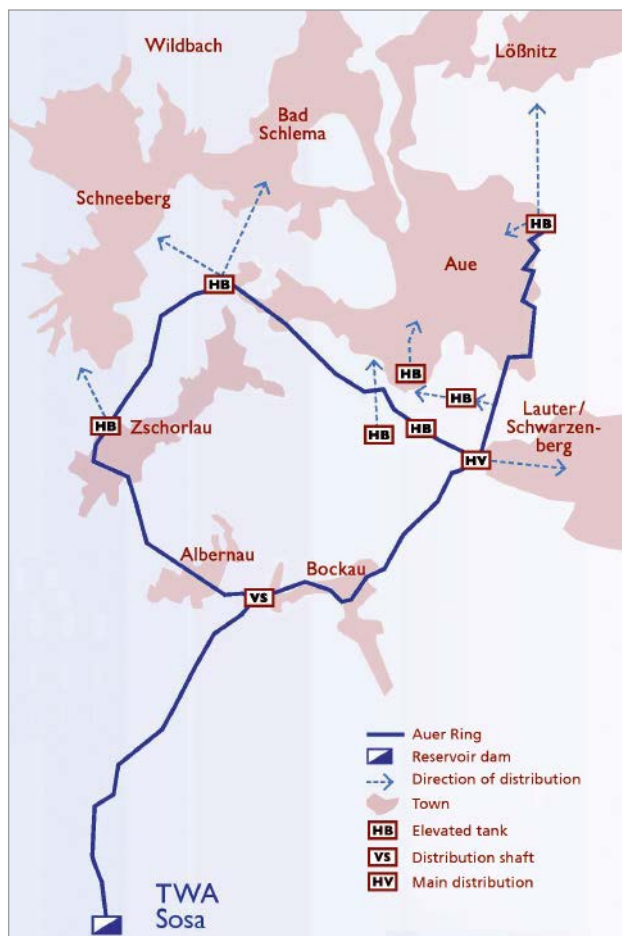

**Figure 2:** Summary plan showing the “Auer Ring” long-distance network

### 3.1 Planning

The clean water reservoir in the Sosa waterworks with its water level of 602 m above sea-level determines the pressure. Three additional elevated tanks are connected to the ring itself, with a storage volume of between 4,000 m<sup>3</sup> and 10,000 m<sup>3</sup>. They are arranged approximately on the same contour at around 565 m above sea-level.

So that the “Auer Ring” can continue to fulfil its function without restriction in the future, in recent years the Westertzgebirge waterworks association has invested about six million euros in the supply system. Extensive hydraulic calculations and simulations in combination with a basic analysis of water requirements resulted in a pipeline which, at DN 400, is ideally designed for the whole ring. This was confirmed by a cost comparison calculation. Because of the existing dead pressures of up to 22 bar and the sometimes extreme pressure shock amplitudes of up to 33 bar, the Westertzgebirge waterworks association decided in favour of using pipes and fittings in ductile cast iron in accordance with EN 545:2010 [1] with BLS® positive locking and restrained push-in joints (Figure 3). The wall thickness of the BLS® pipes used corresponds to wall thickness class K 9 as per EN 545:2006 [2]. Hence it deviates from the minimum wall thicknesses stated in Table 17 of EN 545:2010 [1]. The minimum wall thicknesses and pressures (C class = PFA) stated here only apply for ductile iron pipes with non-restrained push-in joints (e.g. TYTON® push-in joints).



**Figure 3:** Sectional view of BLS® push-in joint with cement mortar coating

Pipes and fittings according to EN 545 [1], [2] are lined as standard with cement mortar based on cements to EN 197-1 [3] for application areas according to DIN 2880 [4]; Annex E to EN 545 [1] also permits other types of cement. In this specific case, however, there was no need to choose any alternative types of cement.

According to the manufacturer's specifications, pipes of nominal size DN 400 with BLS® push-in joints and a minimum wall thickness of 6.4 mm can be used for a PFA of 30 bars. The safety factor for joint failure according to EN 545 [2] is 1.5 + 5 bar (type test pressure). PFA is to be understood as the maximum hydraulic pressure that can be withstood by the pipeline (EN 805 [5]). The maximum allowable operating pressure that a component is capable of withstanding from time to time due to pressure surges for example (PMA) is calculated as follows:

$$\begin{aligned} \text{PMA} &= 1.2 \cdot \text{PFA} \text{ [bar]} \\ &= 1.2 \cdot 30 \text{ bar} = 36 \text{ bar} \end{aligned} \quad (1)$$

The maximum allowable test pressure of a component on the installation site is determined as follows:

$$\begin{aligned} \text{PEA} &= \text{PMA} + 5 \text{ bar} \\ &= 36 \text{ bar} + 5 \text{ bar} = 41 \text{ bar} \end{aligned} \quad (2)$$

In the present application, the pipeline material selected has very high safety reserves. The piping system is equipped throughout with BLS® restrained push-in joints. Therefore there was no need for concrete thrust blocks on bends and branches or at pipeline ends for pressure testing. Also this system makes it possible to dismantle individual components without problem. These properties are advantageous for, among other things, conditioning the cement mortar lining and during pressure testing.

### 3.2 Installation work

So far six individual sections have been completed. Depending on the degree of difficulty and the location, the lengths of the individual construction stages are between 0.5 km and 2.8 km. Altogether the Westertzgebirge water supply company has managed to replace approximately 10.8 km of DN 400 GGG long-distance pipeline. At the same time it was possible to take advantage of synergies by replacing some 3.1 km

of local network pipelines. For the main part the project was able to use the existing pipeline route. At certain points, however, the pipeline takes alternative routes because it is too close to built-up areas or because of logistic advantages, above all for cross-country sections. It is important, particularly for subsequent operation, that the pipeline remains accessible without restriction.

Where the new DN 400 pipeline was laid along the same route, the old DN 350 to DN 500 steel, grey cast iron or reinforced concrete pipes were first of all dug up and removed (**Figures 4 and 5**). Depending on the material of the old pipeline, the pipe trench was opened up over a length of up to 12 m or 14 m, the old material was salvaged and then the trench bottom was prepared. After this, the assembly engineers laid the new DN 400 ductile iron pipes in the pipe trench and assembled the BLS® restrained push-in joint with the V 302 laying tool.



**Figure 4:**  
DN 450 concrete pipes removed from the old pipeline



**Figure 5:**  
DN 350 steel pipes with handmade jointing elements removed from the old pipeline

In places where the local PE network pipeline ran parallel with the long-distance pipeline, sand had to be used as a pipe bedding anyway, so the standard “zinc with protective finishing layer” was sufficient coating for the long-distance pipeline. Particularly in more remote sections, site logistics proved to be a major challenge as there are only a few intersecting roads running to the route of the pipeline; otherwise construction roads had to be built at some expense. Therefore it made sense to dispense with sand bedding by using cement mortar coated pipes (**Figures 6 and 7**).



**Figure 6:**  
The route of the cement mortar coated DN 400 BLS® pipes



**Figure 7:**  
Installation of DN 400 ductile iron pipes with the help of shoring elements

In order to optimise the hydraulic conditions, intermediary high points with a height difference of up to 5 m were levelled. The enormous volumes of excavated soil which this produced further exacerbated the logistic challenges, which once again were able to be overcome by the use of cement mortar coated pipes. After assembly the push-in joints were covered with protective cement mortar sleeves.

At the remaining high and low points, laterally offset venting and draining valves were installed (**Figure 8**). All flanged tees with an eccentric branch were best suited for this (**Figure 9**). The air valves are housed in shafts for ease of maintenance.



**Figure 8:**  
Laterally installed air valves

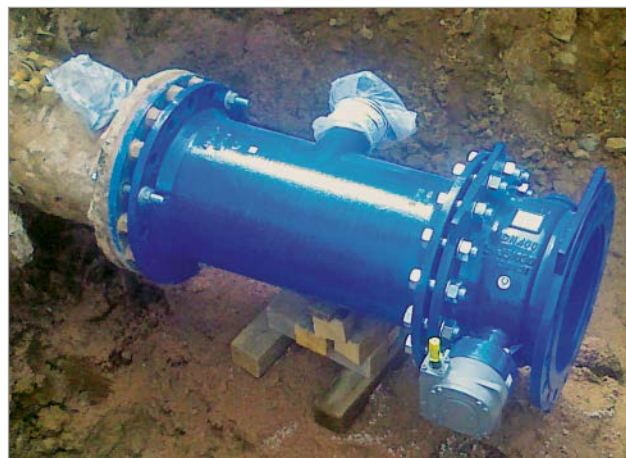

**Figure 9:**  
Eccentrically positioned DN 400/100 branch for lateral air valves

Branch pipelines were installed at selected points in the “Auer Ring”. The Westertzgebirge waterworks association favoured butterfly valves over gate valves for this. Bypasses with flushing devices were installed to make commissioning of the pipeline system easier (**Figure 10**).

If pipe cutting is necessary on site, this involves extra expense for supervision. Only selected DVGW-certified companies are able to produce welding beads for BLS® push-in joints correctly under construction site conditions (**Figure 11**). They are welded using a copper gauge. Post-treatment with corrosion protection coating has to be performed according to the manufacturer’s specifications.



**Figure 10:**  
DN 400 valve intersection with DN 100 bypass



**Figure 11:**  
Applying the welding bead for the BLS® system

### 3.3 Commissioning

The water to be transported by the “Auer Ring” long-distance piping system is very soft with a low buffering capacity. The acid capacity  $K_{S\ 4,3}$  is less than 1.0 mmol/l and the pH value is around 8.3. With the existing ring circuit system stagnation points cannot be excluded. In specific terms, stagnation times of up to six hours must be assumed. The ductile iron pipes to EN 545 [1], [2] used for this project are lined with a mortar based on blast furnace cement. The calcium hydroxide  $\text{Ca}(\text{OH})_2$  produced during the hydration of the cement raises the pH value of the pore water in the mortar considerably. Depending on the composition of the water to be transported, its pH value may even rise above the limit value of 9.5 set by the drinking water regulations.

According to DVGW worksheet W 346 [7] the water in question is to be classified as type  $W_{KSII}$ . Accordingly, counter-measures may be necessary in order to avoid high pH values. As a guide, therefore, a lab test was conducted by adding a sample of pipe to the specific water in a beaker. After 24 hours the pH value increased to 10.9. Therefore the Westertzgebirge water supply company decided to treat the cement mortar lining of the pipes before commissioning in accordance with DVGW worksheet W 346 [7]. Four processes were considered here:

1. pre-carbonation by flushing with harder water,
2. pre-carbonation with soft water modified by additives,
3. treating the cement mortar lining on site with  $\text{CO}_2$ ,
4. treating the cement mortar lining in the factory.

Options 1 and 2 were eliminated because of the lack of availability of harder water and/or sufficient flushing water containers. As a rule they are only appropriate for small nominal sizes and shorter pipe lengths. Option 4 was not practical either. The Westertzgebirge water supply company opted for using the tried and tested process of treating the lining on-site with gaseous carbon dioxide. For this the lining of the pipes has to be dry and, as far as possible, in its condition as delivered. This meant that the greatest possible care was needed during storage, transport and installation of the pipes.

Once the pipeline had been laid, the ends were sealed to be gas-tight and first tested for tightness with air. The negative pressure testing process as per DWA-A 139 [8], for example, is suitable for this. However, this does not replace the pressure testing before commissioning as required by EN 805 [5]. After tightness testing with air, the pipeline is flushed with CO<sub>2</sub> gas from its lowest point. When the gas escaping from the ends of the pipeline reaches a CO<sub>2</sub> concentration of more than 90 % by volume, the pipeline ends are sealed and a pressure of 4 bars is built up. Ductile iron pipes are equally suitable for gases and water in this pressure range.

The calcium hydroxide Ca(OH)<sub>2</sub> of the cement mortar which is soluble in water as the pH value rises reacts with the gaseous carbon dioxide CO<sub>2</sub> and is converted to insoluble calcium carbonate CaCO<sub>3</sub>, whereby the density of the mortar increases and CO<sub>2</sub> is used up (**Equation 3**).

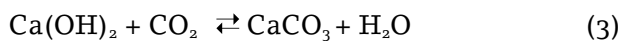

This causes the gas pressure on the inside of the pipe to drop. So that sufficient carbon dioxide can continue to flow, the connection pipeline remains open to the CO<sub>2</sub> source, which is usually a bundle of cylinders (**Figure 12**) or vaporiser system (**Figure 13**). A constant gas pressure must be ensured in the pipeline. If necessary the source of CO<sub>2</sub> may need to be replaced. The pipeline is now the equivalent of a gas container. It is essential that the applicable safety and accident prevention regulations are observed.

During the conditioning measures, the pressure inside the pipe is to be monitored and recorded. If the CO<sub>2</sub> supply is interrupted, then the pressure inside the pipe will fall due to the consumption of CO<sub>2</sub> as a result of the carbonation of the Ca(OH)<sub>2</sub>.

The conditioning of the pipes is finished when the pressure drop due to the CO<sub>2</sub> consumption is less than 0.1 bar/h. At this point the carbon dioxide can practically no longer find a reaction partner. A lasting, barely soluble protective coating is formed on the surface of the cement mortar. It behaves neutrally with respect to the water to be transported: its pH value is no longer affected, or only insignificantly so.



**Figure 12:**  
Bundle of cylinders as the source of CO<sub>2</sub>



**Figure 13:**  
Vaporiser system as the source of CO<sub>2</sub>

The treatment of the cement mortar lining as described in accordance with DVGW worksheet W 346 [7] has no effect on the durability and working life of the lining. In fact the natural conditioning process of young cement mortar linings is accelerated. Depending on weather, this treatment takes 4–7 days; in exceptional cases however a longer time may be needed.

After the CO<sub>2</sub> treatment described, tightness testing is carried out as per EN 805 [5], usually accompanied by disinfection. It is important to note here that, according to DVGW worksheet W 346 [7], hydrogen peroxide and sodium hypochlorite (chlorine bleaching agent) only have a moderate disinfecting effect with soft water. With water of this kind, chlorine dioxide and hydrogen peroxide with 1 % phosphoric acid work considerably better as disinfecting agents [9].

## 4 Final comment

The expectations invested in the selected pipe material in matters of cost effectiveness and technical security were entirely met. In close collaboration between client, planning engineers, construction companies and pipe suppliers, a challenging structure was replaced in sections over short construction times. Working in this way, the Westerzgebirge water supply association will certainly be able to tackle the remaining sections (**Figure 14**).



**Figure 14:**  
Construction site panorama with the old mining installations in the Western Ore Mountains

## Bibliography

- [1] EN 545: 2010
- [2] EN 545: 2006
- [3] EN 197-1: 2014
- [4] DIN 2880: 1999-01
- [5] EN 805: 2003
- [6] Notification of the new version of the German drinking water regulations dated 2 August 2013  
Federal Law Gazette Part I no. 46 dated 07.08.2013
- [7] DVGW worksheet W 346: 2000-08
- [8] DWA worksheet A 139: 2010-01
- [9] E-Book 10.2015, chapter 21  
download: [www.eadips.org/e-book-e/](http://www.eadips.org/e-book-e/)

## Author

Dr.-Ing. André Clauß  
Zweckverband Wasserwerke Westerzgebirge  
Am Wasserwerk 14  
08340 Schwarzenberg/Germany  
Phone: +49 (0)3774/144-155  
E-mail: [andre.clauss@wasserwerke-westerzgebirge.de](mailto:andre.clauss@wasserwerke-westerzgebirge.de)

**Ductile iron pipe systems can be shown to produce true sustainability!**

## Kanzenbach power station (Tyrol) with a high boost in output – increased security provided by “leak-before-break” fracture mechanics design of turbine pipes

*By Christian Auer, Andreas Hammer, Friedrich Karau, Sven Kunow,*

*Anton Rass, Werner Rudig and Oswin Schüller*

### 1 Introduction

While in the past ductile iron pipes were mainly used for the transport of drinking water and wastewater, these days new areas of use are opening up such as penstock pipelines for hydroelectric power stations. In particular as a result of government incentives for renewable energy, movement can be seen in all areas – wind power, solar energy and not least the use of water power. With the developments in existence today, a lot of resources are already being exploited in the Alpine region but there are still considerable reserves to be utilised by modernising and increasing the output of existing plants, as has happened with the extension of the TIWAG (Tiroler Wasserkraft AG) installation in the district of Flauring located in the Tyrolean Kanzenbach valley. The latest turbines, generators and control technology are essential conditions for better efficiency. But, with further development, the turbine pipelines can also produce better yields and above all contribute to increased safety. Because of the energy stored in the reservoir or water tower, the failure of a pipe, on a steep slope for example, can have catastrophic effects. Therefore safety considerations take first place for the pressure pipelines of hydropower stations.

Hence early recognition of the beginnings of pipe damage which, particularly with high pressure applications, could be a considerable risk is essential. If a crack appears in the pipe then this has to develop into a through-wall crack before it comes to the pipeline actually bursting. This is referred to as “leak-before-break” behaviour of the pipeline, i.e. the fault goes through the wall and leaks become detect-

able before the pipe finally fails. Hence the defect can be eliminated by repairing or replacing the pipe in good time before things become critical. Complicated leakage warning equipment only really makes sense under these conditions in areas where safety is critical.

However, particularly in challenging locations such as in the high-Alpine topography in the area of turbine pipelines, the replacement of a defective pipeline is very costly. For this reason attempts are made right from the planning stage to design these pipelines in such a way that an unstable crack development does not happen. However as yet there are no standard specifications or design bases for this and attempts are often made to manage with other known parameters such as elongation at fracture  $A_5$ . Sometimes planners also rely on determining the impact energy consumed, as required in American standards ANSI/AWWA C 151-09/A21.51-09 [1] for example. But impact energy consumed is only an approximation as well and it merely describes behaviour under an impact and hence short-lived load. With a pressure pipe, however, crack formation and crack growth are processes which are many orders of magnitude longer lasting than the force impact of the notched bar impact test.

## 2 Turbine pipelines – a domain for the ductile iron pipe system

In 1997 Vorarlberger Kraftwerke AG put a turbine pipeline consisting of DN 1400 ductile iron pipes into operation at the “Klösterle” hydropower station for which the “leak-before-break” principle was implemented in practice for the first time [2].

For the new turbine pipeline at Kanzingbach as well, the owner and operator TIWAG asked for the “leak-before-break” safety concept, which was included in the criteria for selecting the pipe material. This choice is influenced by a number of factors.

### 2.1 Safety

Ductile cast iron has always been considered as a highly flexible material because of its particular structure. A large number of the properties of ductile iron pipes for the transport of drinking water or wastewater are defined in the familiar standards EN 545 [3] and EN 598 [4] and are routinely checked by pipe manufacturers. When it comes to additional unplanned loads due to violent impacts not caused by operation-related events, such as landslides, rockfalls or earthquakes the ductile iron pipe has great reserves. What is more, with the centrifugal casting process the wall thickness of iron pipes can be almost arbitrarily adapted to suit the pressures occurring.

### 2.2 Handling ductile iron pipes in Alpine terrain

For one thing, it saves having to transport bedding material to areas which are often difficult to access. The excavation material set aside on site is quite sufficient for this purpose. For another thing, the proven joint technology is an advantage when using ductile iron pipe systems on steep slopes: with the so-called open-close method the pipe trench is only opened up for the length of one pipe and then filled again once the joint has been assembled. This means that the risks of a change in the weather can be kept within limits.

Ductile iron pipes are supplied with a cement mortar coating to EN 15542 [5] (**Figure 1**). The protection works in two ways: mechanical protection and protection against corrosion. The pipe trench can be backfilled with stony and compressible excavation material.

Tiroler Wasserkraft AG, as the largest operator of hydroelectric power stations in the Austrian Tyrol, also places emphasis on safety and ease of handling. It also defines the toughness of its pipe materials using the criteria of fracture mechanics and sets down certain requirements in the project described.

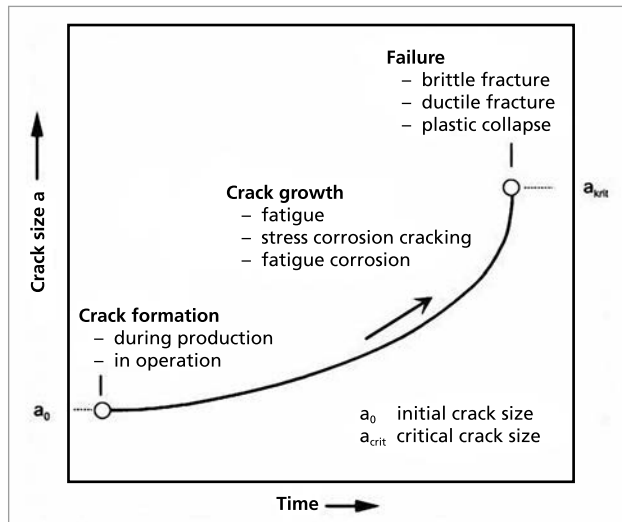

**Figure 1:** Delivery of ductile iron pipes for the turbine pipeline of the new hydropower station at Kanzingbach (Tyrol)



### 3 Elastic-plastic fracture mechanics

Elastic-plastic fracture mechanics, also known as yielding fracture mechanics, describes crack propagation under static loading taking account of plastic deformation, as it occurs in all ductile materials. Before a crack which forms during production, installation or operation reaches a critical dimension, it grows during its operating



**Figure 2:**  
Progress of a crack over time

time under dynamic loads (cyclical crack growth, fatigue), corrosion fatigue cracking and/or stress corrosion. The progress of a crack over time is illustrated in **Figure 2**.

**Figure 3** shows a typical “leak-before-break” diagram with the stages of crack formation.

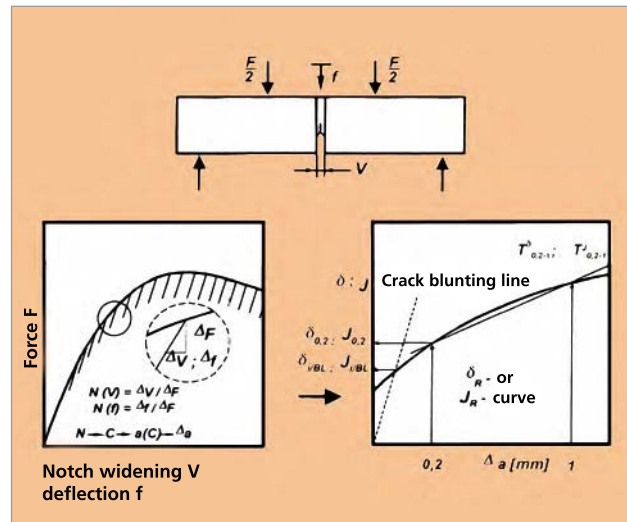

**Figure 4:**  
Determination and definition of characteristic fracture mechanics values of the J-integral concept [7]

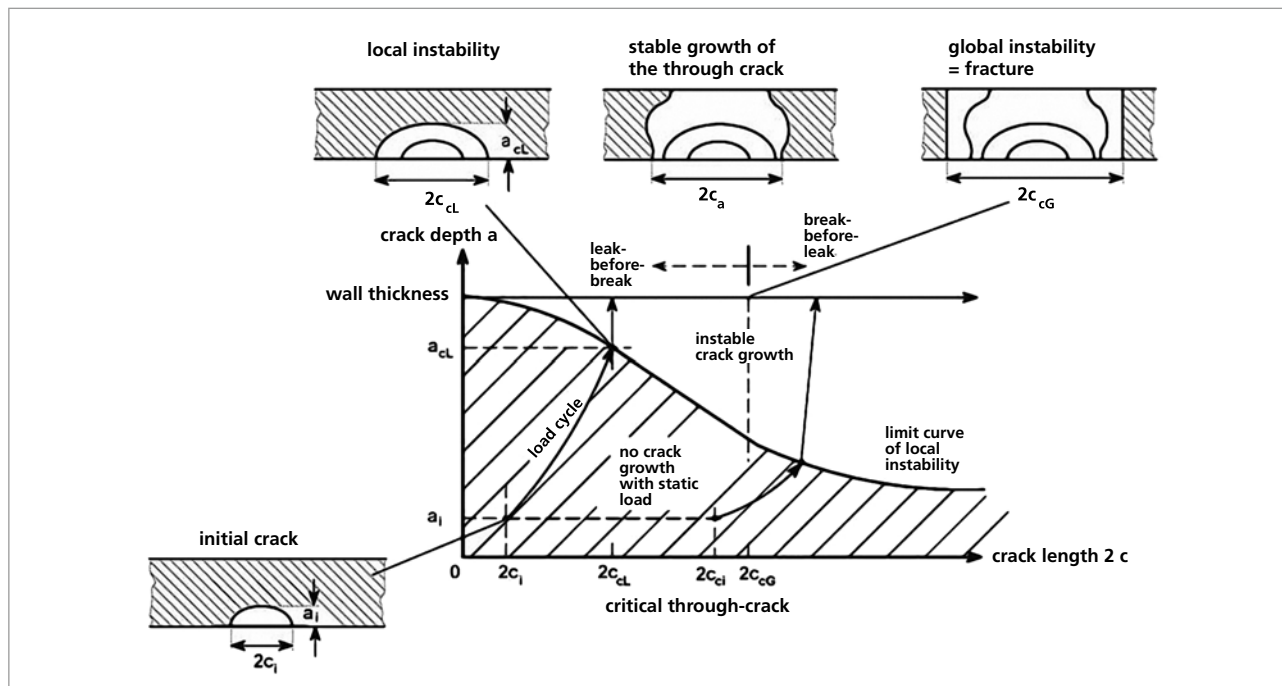

**Figure 3:**  
Characteristic “leak-before-break” diagram: fatigue fracture under alternating stress and critical crack sizes for a tough material and a defined load

Source: Westphal, Hahn, 1989

Static crack propagation is determined with the help of crack resistance curves. Fracture toughness  $J_{0.2}$  here is the energy in the area of the crack tip which describes the propagation of the crack over a length of 0.2 mm. It represents the critical crack size and hence the limit value of the design. This description has been very much simplified; detailed information on this can be found e.g. in [6]. The method of crack resistance measurement and the resulting diagram are shown in **Figure 4**.

As illustrated in **Figure 4**, a frequently used test procedure uses the bending load, in this case with a 4-point bend. But a combined tensile and bending load using a CT specimen (CT = compact tension) is also possible. A cube-shaped specimen is given a V-shaped notch in the same way as with the notched bar impact test. In addition a crack is introduced into this specimen in order to record crack resistance curves by dynamic loading. The length of this is determined before the test as it has a random length which can differ from one specimen to the next. By stressing this specimen in the 4-point bending test (**Figure 4, top**) the widening of the notch and/or the deflection is determined (**Figure 4, bottom left**). These results are used to calculate the physical work  $J$  required for widening the crack  $\Delta_a$  (**Figure 4, bottom right**). The  $J_{0.2}$  value which is of interest in these investigations can then be read off at  $\Delta_a = 0.2$  mm.

When designing pipelines according to the “leak-before-break” criterion, the ratio of the permissible through-crack to the wall thickness still also plays an important role. The length of the through-crack here can be equated with the longest crack length not detectable in production. The greater this ratio is, the higher  $J_{0.2}$  must also be in order to achieve a stable leak. **Figure 5** shows this dependency for different application cases.

#### 4 Investigations carried out

For the turbine pipeline of the Kanzingbach hydroelectric power station, owner and operator TIWAG also asked for the safety concept as presented above, namely “leak-before-break”. This requirement is associated with a further development of the well-known “ductile cast iron” material, the aim of which was yet to be defined.

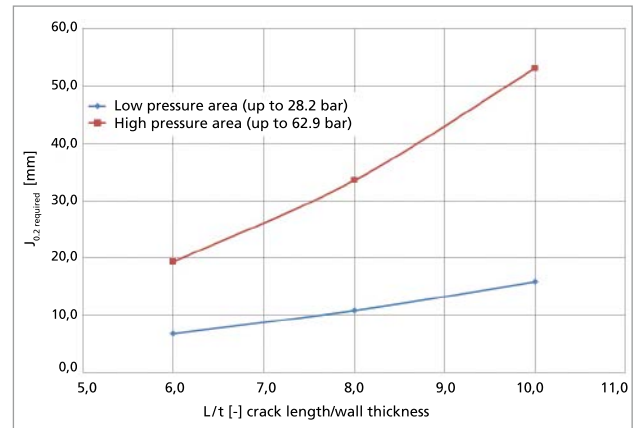

**Figure 5:** Required fracture toughness  $J_{0.2}$  depending on the ratio of the through-crack length to the wall thickness for two application areas (Source: TIWAG)

After some preliminary talks with TIWAG a requirement was finally formulated which made provision for tolerable through-crack lengths to the extent of six times the wall thickness. This results in fracture toughness values of  $KJ_{0.2} = 1,900$  N/mm<sup>3/2</sup> and crack resistance energies of  $J_{0.2} = 19.3$  kJ/m<sup>2</sup>.

The test centre for material and mechanical engineering in Innsbruck (V.A.M.) determined the fracture toughness values direct on specimens taken from the pipes and fittings. To do this, a defined crack was introduced into the test specimens with a resonance test system (“pre-cracking”). Then the fracture toughness and the crack resistance curve were determined on a 3-point bending test specimen using the partial unloading process (also known as the compliance method) in accordance with ISO 12135 [8].

The required properties were achieved in the course of joint research and development work by the two pipe manufacturers TIROLER ROHRE GmbH – TRM and Duktus Rohrsysteme Wetzlar GmbH together with the client TIWAG and the V.A.M. test centre in Innsbruck. The development included a modification of the material. In practice this means that special types of pig iron and scrap had to be used for the new composition. In this way it was possible to produce the desired ferritic structure with its extremely fracture-tough properties.

By the end of the research work the material conventionally used for ductile iron pipes according to EN 545 [3] (similar to GJS 450-10 as per EN 1563 [9], [10]) can be compared with

the material modified for the requirements of TIWAG on the basis of the different mechanical and technological properties. **Table 1** shows the comparison at room temperature. In addition the impact bending energy used in the temperature range between  $-40\text{ }^{\circ}\text{C}$  and room temperature was determined. The measurement results are plotted in the graph in **Figure 6**.

At first glance the large differences between the two materials are apparent. While GJS 450-10 is already exhausted or overstressed, the modified material clearly exceeds the elongation at fracture requirements  $> 10\%$ , which however is at the expense of tensile strength and technical yield strength. Also the impact energy consumed is considerably improved with the modified material over the entire temperature range tested.

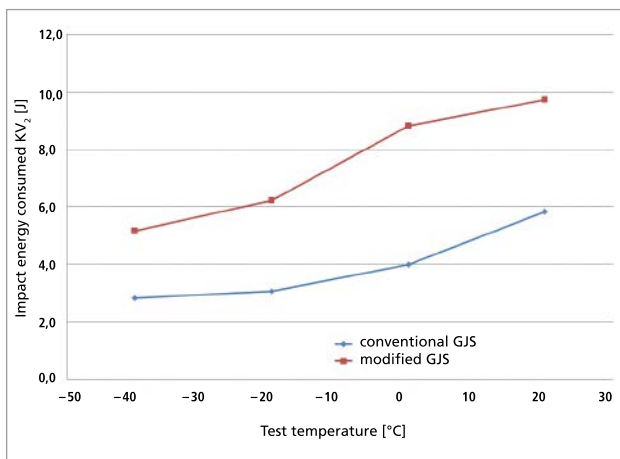

**Figure 6:** ISO-V impact energy consumed in the temperature range  $-40\text{ }^{\circ}\text{C}$  to room temperature

However the tests also show that an assessment about the impact energy consumed using elastic-plastic fracture mechanics alone is not possible because the material GJS 450-10 would be considerably undervalued here. Hence the impact energy consumed is to be assessed very critically as a measurement parameter for the sustained loading of the pipe.

After completion of the metallurgical and production technology development work, improved material properties could be achieved: the pipes and fittings in ductile cast iron standardised for water pipelines in EN 545 [3] must have breaking elongation values of at least  $12\%$ , if  $R_{p0.2} \geq 270\text{ MPa}$ . By comparison, the material optimised in terms of fracture mechanics has values of up to  $20\%$  and achieves the required fracture toughness values while observing the mechanical properties required in EN 545 [3] (tensile strength  $\geq 420\text{ MPa}$  and  $0.2\%$  yield strength  $\geq 270\text{ MPa}$ ).

## 5 Pipeline construction

Before the construction of the powerhouse the  $4.5\text{ km}$  long pressure pipeline had to be installed. The DN 600 ductile iron pipes used for this were developed by the traditional Tyrolean manufacturer TRM together with Duktus Rohrsysteme Wetzlar GmbH and delivered by TRM. In the upper area of the route – apart from about  $300\text{ m}$  – the pipeline runs along existing pasturing pathways. Here restrained push-in joints (PFA = 25 bar) from the BLS®/VRS®-T system were used, meaning that the construction of concrete thrust blocks was not necessary. In the lower lying section, in which numerous pipe bends were also installed, the production of permanent anchors in the form of concrete

**Table 1:**

Results of the tensile test and fracture mechanics tests on GJS 450-10 and the modified material

	GJS 450-10	Modified material
Tensile strength $R_m$ [MPa]	420*	429**
Technical yield strength $R_{p0.2}$ [MPa]	270*	279**
Breaking elongation $A_5$ [%]	10*	17,9**
Impact energy consumed $KV_2$ [J]	5,8**	11,8**
$J_{0.2}$ [kJ/m <sup>2</sup> ]	14**	23**
* Minimum value as per EN 545 [3] ** Measured value		

thrust blocks was unavoidable. In this area of the route the client used ductile iron pipes with the conventional TYTON® push-in joints (Figure 7).

The old route was deliberately not chosen for the new pipeline. This meant that the old power station could stay in operation and produce power for the entire construction time of one and a half years. However, because of the difficult topographical conditions this entailed some considerable challenges in some cases. During the summer pasturing period between 15 June and 15 September no pipes could be laid in this area. But because of the very late

onset of winter the work could nevertheless be continued on the pipe and cable route until the middle of December 2014.

A further challenge for the installation team commissioned was the rocky subsoil in the higher grazing ground. The advantage of a pipe trench in the rock (Figure 8) lies above all in the fact that the stability of a pressure pipeline installed in it is distinctly increased. However, producing it was anything but simple.

The construction crew used an excavator with a cutter head (Figure 9) as well as other excavators which removed the material cut out and which were used for the installation of the pipes.



Figure 7: Laying the pipes with TYTON® push-in joints in front of the intake structure with a Y-pipe



Figure 8: Construction work in the rock



Figure 9: Using the cutter-head excavator



**Figure 10:**  
Parallel installation of DN 200 and DN 600 ductile iron pipes

In this way it was not unusual to have six to eight excavators in use along the route at the same time in order to keep the installation work within the narrow timeframe set. Altogether the cutting work for the pipe route extended over a length of 2 km.

A not inconsiderable synergy effect was exploited in favour of the community during the installation of the pipes. There was an old, pressureless pipeline which ran from an elevated tank to the drinking water source on the Flaurlinger Alm, which TIWAG would have to have replaced anyway. For this reason a small DN 200 pressure pipeline – also in ductile cast iron – was also installed in the pipe trench (**Figure 10**), giving the community of Flaurling the option of having a drinking water power plant, which is already being implemented today.

Great value was placed not only on the durability and robustness of the new small power station but also on its implementation being as environmentally compatible as possible: about 150 m<sup>2</sup> of wetland has been established in the area of the powerhouse. This wetland has been designed according to ecological viewpoints and

meanwhile is providing a habitat above all for amphibians but also for other animal and plant species. No protected areas have been disturbed by the implementation of the project. The parts of the old plant are being dismantled and currently a so-called “conveyancing operation” is in preparation. Added to this is the fact that one of the strict specifications for aquatic ecosystems is being met concerning residual water output into the residual flow stretch of the Kanzingbach. This represents a striking improvement as compared with the previous state of affairs. In concrete terms, 15 % of the naturally occurring water, but at least 100 L/s in low water times, is now being sent to the residual water stretch. Regulation of the inflow of water is fully automatic.

## 6 Schedule and conclusion

The construction work was started at the beginning of October 2013, whereby the check dam structure for water catchment was still able to be completed in the same year. The construction companies commissioned were able to begin installation of the pressure pipeline in

Spring 2014, once nature had thawed out in the Flaurling valley. After some rapid progress with construction in the following months, the toping-out ceremony took place at the beginning of October 2014. With the formal commissioning on 11 June 2015 the construction project came to a worthy conclusion after a construction time of around a year and a half.

With the replacement of the two old power stations with a new one, TIWAG is able to use the water of the Kanzingbach more efficiently and ensure the power supply of at least 4,000 households. The new hydroelectric power station makes a contribution to the ecological, efficient and sustainable expansion of home-grown water power. Small water resources are worth careful handling!

### Bibliography

- [1] ANSI/AWWA C 151-09/A21.51-09: 2009
- [2] Fussenegger, F., Mathis, R., Titze, E., Rammelsberg, J. and Schütz, M. GUSSROHR-TECHNIK [CAST IRON PIPE TECHNOLOGY] Issue 32 (1997), p. 58 ff. Download: [www.eadips.org/jahreshefte-d/](http://www.eadips.org/jahreshefte-d/)
- [3] EN 545: 2010
- [4] EN 598: 2007+A1:2009
- [5] EN 15542: 2008
- [6] Homepage: <http://bruchmechanik.info/bruchmechanik-themen/grundlagen/kenn-werte-der-bruchmechanik/>
- [7] Pusch, G. Konstruieren + Gießen [construction + casting], Issue 33 (2008), no. 4, p. 2 ff.
- [8] ISO 12135: 2002-12
- [9] EN 1563: 2011
- [10] prEN 1563: 2015

### Authors

Ing. Christian Auer  
TIROLER ROHRE GmbH – TRM  
Innsbrucker Strasse 51  
6060 Hall i. T./Austria  
Phone: +43 (0)5223/503-115  
E-mail: christian.auer@trm.at

Dipl.-Ing. Andreas Hammer  
TIWAG-Tiroler Wasserkraft AG  
Engineering Services division  
Eduard-Wallnöfer-Platz 2  
6020 Innsbruck/Austria  
Phone: +43 (0)50607/21392  
E-mail: andreas.hammer@tiwag.at

Dr. rer. nat. Friedrich Karau  
Duktus Rohrsysteme Wetzlar GmbH  
Development and Technology  
Sophienstraße 52-54  
35576 Wetzlar/Germany  
Phone: +49 (0)6441/49-1255  
E-mail: friedrich.karau@duktus.com

Dipl.-Ing. Sven Kunow  
Duktus Rohrsysteme Wetzlar GmbH  
Development and Technology  
Sophienstraße 52-54  
35576 Wetzlar/Germany  
Phone: +49 (0)6441/49-1266  
E-mail: sven.kunow@duktus.com

Ing. Anton Rass  
V.A.M. Innsbruck – Test centre for material and mechanical engineering  
Anichstraße 26-28  
6020 Innsbruck/Austria  
Phone: +43 (0)512/59717-260  
E-mail: anton.rass@vam-innsbruck.at

Ing. Werner Rudig  
TIWAG-Tiroler Wasserkraft AG  
Hydropower Planning Department  
Eduard-Wallnöfer-Platz 2  
6020 Innsbruck/Austria  
Phone: +43 (0)50607/21354  
E-mail: werner.rudig@tiwag.at

Ing. Oswin Schüller  
TIWAG-Tiroler Wasserkraft AG  
Plant and Testing Technology Team  
Eduard-Wallnöfer-Platz 2  
6020 Innsbruck/Austria  
Phone: +43 (0)50607/21245  
E-mail: oswin.schueller@tiwag.at

## Trenchless through the Badrina biotope – enthusiastic visitors follow the pipe pulling-in process at the site open day

By Uwe Hoffmann and Stephan Hofmann

### 1 Introduction

The Delitzsch-Rackwitzer water supply association (DERAWA) was faced with one of its largest investment projects in Badrina: in order to stabilize the raw water supply for Delitzsch and its surrounding communities in Saxony it was necessary to replace an old pipeline which in part runs through the Badrina biotope (**Figure 1**). The outstanding feature in Badrina is the oligotrophic (low in nutrients and humus) to mesotrophic (medium level of nutrients), calcareous standing water. Bodies of water of this habitat type are very rare in the natural environment. The ponds, left in their natural state, consist of bodies of clear water relatively low in nutrients which have populations of stonewort spread over large areas. They are in a good state of preservation. Although there is direct access from the road, anthropogenic interference is low. However use as fishing or angling waters or driving over the land with heavy machines would massively endanger the present favourable state of preservation [1]. The biotope in Badrina is part of the "Natura 2000" network [2], the official name of a coherent network of protected areas which has been established within the European Union in accordance with EEC Directive 92/43 (fauna/flora habitat directive, or FFH directive). Its aim is to protect endangered native plants and animal species and their natural habitats in the countries of Europe. The network of protected areas also includes those areas designated in EEC Directive 79/409, known as the wild birds directive [3].



**Figure 1:**  
The Badrina biotope

### 2 The initial situation

The Delitzsch water supply association draws its raw water from the Prellheide North and South well catchment areas and from the Spröda district. A 16 km long DN 500 steel transport pipeline was laid specifically for this purpose in the 1970's. The pipeline stretches from Badrina, a district of Delitzsch, to Scholitz through sensitive biotopes such as wetland meadows and reed-beds. Unfortunately over recent years it has often been necessary to carry out repair work because the steel pipeline has been afflicted by corrosion damage. The susceptibility of the 40-plus year old pipeline to faults and failures had been steadily increasing. Therefore the replacement of the section of pipeline in the Badrina biotope was looming for DERAWA. It was the largest and most expensive investment for many years. It cost around half a million euros to put the new pipeline in the ground in place of the old one [4].

The local supply company depends on this pipeline for the supply of drinking water to the 48,000 inhabitants in its service area as well as the industrial, business, commercial and agricultural concerns and public institutions established there.

### 3 Planning

The planning of this measure took DERAWA more than a year. Four nature reserves appear on the construction plans for the 480 m long pipeline, so the planners decided on trenchless installation using the HDD technique with DN 500 ductile iron pipes with BLS® restrained push-in joints and cement mortar coating to EN 15542 [5]. Because of the local circumstances described, the only method to use was the environmentally friendly horizontal directional drilling process according to DVGW worksheet GW 321 [6], in this case with gyro-compass control. This uses navigation software and a ring laser gyroscope to direct and control the drill so that it stays on the reference line with centimetre precision between the starting pit and the target pit. This special version was used because of the ban on entering the biotope; the directional drilling technique normally used involves controlling the laying process with magnetic tracking systems along the route. In this case the path between starting and target pit was controlled on the computer monitor only. The Badrina soil was pushed out metre by metre by a bentonite suspension – a mixture of natural clay and water – discharged under high pressure from the tip of the drill head. The suspension supports the drill hole and is later recycled. Because of the restricted space available, the pipeline was assembled using the single pipe technique on an angled assembly ramp; an advantage when there is a lack of space around the starting pit. Contrary to some initial concerns regarding the time that assembly would take using cement mortar coated shrink-on sleeves, after a short familiarisation period some very short assembly times were achieved. So, despite the single-pipe assembly, the pipeline was able to be pulled in within a few hours. A robust and resistant joint protection with shrink-on sleeves keeps both the directional drilling suspension and the groundwater of the biotope away from the joint gap.

A time window of around 48 hours reserve supply was available at the waterworks until the reconnection of the new pipeline.

### 4 Construction work

For the directional drilling, the Beermann Bohrtechnik GmbH company from Zeitz used drilling equipment with a traction force of 1,000 kN. The first 200 mm drilling was completed within a day and the six workers from the drilling company did not come up against any obstacles. In the second run, the diameter was increased to 750 mm and finally widened to 920 mm. Using heavy-duty equipment, the string of new, 6 m long DN 500 pipes were pulled through this borehole. The single-pipe assembly of the DN 500 BLS® pipes was carried out by the construction company Josef Pfaffinger Leipzig Baugesellschaft mbH. An assembly ramp was used to introduce the pipes into the borehole at a target entry angle of 11° (**Figure 2**). The excavation pit was approximately 15 m long. Before pulling in, the joint of the ductile iron pipe was protected with a shrink-on sleeve and a sheet steel cone.

The pipes were assembled quickly and without complication with the help of an excavator standing ready on site. The BLS® push-in joints were “locked” using the traction of the drilling equipment. The operation of pulling in the pipes was commenced on 16.09.2015 at about 2.30 pm and it was finished at 3.00 am the next morning without any particular incidents. After a brief orientation phase, assembly times of around 9 minutes were able to be achieved. The pipe pulling was monitored with a tensile force gauge (**Figure 3**).

Once the pipes had been successfully pulled in the new pipeline was connected up to the existing system with PN 10 ductile cast iron fittings. The starting and target pits were dismantled and the whole job was finished by the end of October.

### 5 Site open day in Badrina

Together with the water supply company, the pipe manufacturer used this particular project as an opportunity to invite interested parties, planners and clients from the surrounding communities to a site open day on 16.09.2015. After a tour of the waterworks in Delitzsch the visitors could see for themselves just how uncomplicated, fast and perfect the trenchless installation of ductile iron pipes can be. The guests followed the assembly of the BLS® push-in joints and the subsequent pulling-in process with great interest. There was a high degree of





**Figure 2:**  
Assembly ramp for single pipe assembly



**Figure 3:**  
Traction head with tensile force gauge

enthusiasm, especially since most of the visitors were aware of how much depends on the successful installation of the main Delitzsch-Rackwitz water supply pipeline.

Thanks to the flexible BLS® push-in joints the pipeline could be installed through the Badrina biotope safely and rapidly using the trenchless laying technique. And nobody went in to disturb the sensitive ecosystem.

## 6 Project data

- HDD single pipe assembly, DN 500, BLS®
- External pipe protection: cement mortar coating to EN 15542 [5]
- Joint protection:  
shrink-on sleeve and sheet steel cone
- Length of pipeline: 432 m
- Maximum tensile force of the drilling machine: 1,000 kN
- Permissible tensile force for DN 500 ductile iron pipes: 860 kN
- Maximum tensile force measured: 60 kN
- Average assembly time for the completion of a DN 500 BLS® push-in joint using a shrink-on sleeve and sheet steel cone: 12 min

## 7 Conclusion

It is precisely in complicated situations with obstacles and particular requirements that the trenchless HDD technique in combination with ductile iron pipes has proved its worth time and again. The robustness of the pipes, maximum security against the internal pressures occurring and the high external load capacity are guarantees of high operational reliability and a long working life. The new pipeline of ductile iron pipes should now last for at least the next 50 years.

## Bibliography

- [1] Managementplan für das Gebiet Nr. 210, Vegetationskunde und Landschaftsökologie (IVL)  
[Management plan for area no. 210, Vegetation and landscape ecology], Leipzig 2010
- [2] Tables of European protection areas (Natura 2000) and protected landscapes  
Source: Wikipedia 2011-07-10
- [3] EUR-Lex 128076 – EU: 1992-05-21
- [4] Jacob, C.  
Badrinaer Biotop entscheidet über Wasserversorgung der Region  
Article in the Leipziger Volkszeitung 2015-09-10
- [5] EN 15542: 2008
- [6] DVGW worksheet GW 321: 2003-10

## Authors

Uwe Hoffmann  
Duktus Rohrsysteme Wetzlar GmbH  
Dessauer Straße 225  
06886 Lutherstadt Wittenberg/Germany  
Phone: +49 (0)172/7221174  
E-mail: uwe.hoffmann@duktus.com

Dipl.-Ing. Stephan Hofmann  
Duktus Rohrsysteme Wetzlar GmbH  
Sophienstraße 52-54  
35576 Wetzlar/Germany  
Phone: +49 (0)6441/49-2924  
E-mail: stephan.hofmann@duktus.com

## Client, planning and site management

Andreas Schütz  
Delitzsch-Rackwitzer Wasserversorgung  
Bitterfelder Straße 80  
04509 Delitzsch/Germany  
Phone: +49 (0)34202/3408-61  
E-mail: wasser@zv-derawa.de

## Construction companies

Josef Pfaffinger Leipzig Baugesellschaft mbH  
Sven Fischer  
Föpplstraße 1  
04347 Leipzig/Germany  
Phone: +49 (0)341/24542-30  
E-mail: leipzig@pfaffinger.com

Beermann Bohrtechnik GmbH Frank Sauer  
Heinrich-Niemeyer-Straße 50  
48477 Hörstel-Riesenbeck/Germany  
Phone: +49 (0)171/4223795  
E-mail: info@beermann-bohrtechnik.de



**EADIPS®** European Association for  
**Ductile Iron Pipe Systems**  
**FGR®** Fachgemeinschaft Guss-Rohrsysteme



Sustainably superior –  
ductile iron pipe systems

Ductile iron pipe systems for  
drinking water supply and  
sewerage applications

Duktile Guss-Rohrsysteme  
für die Trinkwasser- und  
Abwasserentsorgung

- Pipes / Rohre
- Fittings / Formstücke
- Valves / Armaturen

[www.eadips.org](http://www.eadips.org)

## Torrent bed-load barrier on the Schnanner Bach

*By Werner Siegele and Christoph Aigner*



**Figure 1:**  
Arch dam on the Schnanner Bach – the three openings marked in yellow are each fitted with an inflatable weir system

### 1 Previous history

The Rosanna is a stream which rises in the Verwall mountains (in the Tyrol, close to the border of Vorarlberg) and flows into the River Inn. One of its tributaries is the Schnanner Bach. The existing arch dam on the Schnanner Bach was built to protect the town of Schnann against flooding. In the case of a mudslide, a very large amount of bed-load material often gets into the stream. However, as little deadwood and coarse material occurs in this area, the opening in the barrier does not close by itself with the result that only a small amount of bed-load is

held back. Hence the material passes the barrier and is transported to the area where the stream flows into the Rosanna. This transport of bed-load can take on such proportions that the drag forces produced by the flow of water in the Rosanna are not sufficient to transport the material further. In the past this has led to flooding in the town of Schnann on many occasions and so to corresponding resentment among the townspeople affected. Therefore the torrent and avalanche containment department of the Austrian Ministry for Agriculture and Forestry developed the prototype of a bed-load barrier for flood protection.

## 2 Requirements

Because of these problems, Michael Posch from the torrent and avalanche containment department for the district of Pettneu and the state of Tyrol was appointed project manager with the task of finding a solution.

More bed-load material needed to be retained in the area of the barrier and a backing up of the stream on account of too high an accretion avoided. As soon as the receiving waters are free again, the retained material should be released and transported away as cost effectively as possible.

## 3 Possible solutions

In collaboration with civil engineers Matthias Luxner and Engelhart Gstrein from Imst, different possibilities were discussed for holding back bed-load by a flap or gate which would be opened in a controlled way after a mudslide. However, since the blocking of such devices cannot be excluded, another system needed to be found.

The idea arose of using a special inflatable weir system and of developing a prototype for this application. Experiences with inflatable weirs for other applications had shown that the membrane can withstand the friction caused by the bed-load very well.

A flow model was also recreated at the University of Innsbruck in order to simulate the situation in the area of the outflow.

## 4 A summary of the system

The arch dam has four openings one on top of the other (**Figure 1**). The top three are closed by inflatable weirs. The normal flow of water of the stream is channelled through the bottom opening.

For filling the tubes of the weir system, there is a 30 m<sup>3</sup> water tank above the bed-load dam on the right. The difficult conditions of the terrain require a reinforced concrete container. With this arrangement, the valves of the pipelines simply have to be opened in order to fill the weirs.

The tubes can be filled from the high-level tank by water pressure of up to 4 bar.

This container can be filled by a pump from the pumping house. The pumping house acts as a control and switchgear station and is located below the dam. Cast iron pipelines connect the pump with the high-level tank and the tank with the inflatable weir system (**Figure 2**).



**Figure 2:**  
System diagram

The piping system also has an important role to play in this project. The pipes must be able to be supported by, but clear of, the barrier wall and be in UV-resistant material. Because the site is so difficult to access, they must be easy to install.

Therefore the decision went to ductile cast iron. With its robustness and the VRS<sup>®</sup>-T push-in joint system it resists even extreme attacks, such as rockfalls. Its mechanical resistance is a pre-condition for secure operation (**Figures 3 and 4**). **Table 1** contains the project data for the torrent bed-load barrier on the Schnanner Bach. Because of the high safety requirements, the pipe manufacturer's employees produced some special adaptors and they also supported the assembly team with their know-how.

For the pre-assembly of the membranes, a 1:1 model in wood was prepared in the torrent and avalanche containment building yard. The membranes were mounted on this and then the entire thing was transported to the site and installed.



**Figure 3:**  
Ductile iron pipeline from the high-level tank to the barrier



**Figure 4:**  
Ductile iron pipelines in the weir area

**Table 1:**  
Project data for the torrent bed-load barrier on the Schnanner Bach

Project name	Torrent bed-load barrier on the Schnanner Bach		
Place	Schnann am Arlberg (Tyrol)		
Client	District of Pettneu		
Construction company/developer	Torrent and avalanche containment department of the Austrian Ministry for Agriculture and Forestry		
Planning	Engelbert Gstrein & Mathias Luxner		
Total construction time	Approx. 1 year		
Main pipelines	150 m	DN 200	10 bar
Joining elements	VRS®-T push-in joints		
Coating	PUR-Longlife		
Lining	Cement mortar lining		
Particular requirements	High mechanical impacts, robustness		

## 5 Operation

The entire area where the Schnanner Bach flows out into the receiving waters and the bed-load stretch is video-monitored. The system is activated as soon as build-ups are observed due to too heavy a transport of bed-load.

Because of the natural height difference, the inlet pressure in the pipes between high-level tank and inflatable weir is up to 4 bar.

To start with, the weirs are gently filled at a pressure of only 0.3 bar. There is a tilt sensor installed in the tube which measures the increasing pressure of the bed-load, meaning that the pressure on the weirs can automatically be increased further.

If material which has already been washed into the receiving waters has been transported further thereby making room in the outflow area, the inflatable weirs can be drained again and the openings released.

The surge thus released should carry bed-load with it again, thereby avoiding expensive dredging and transport work. Also erosion of the receiving waters is prevented in this way.

When the tubes are emptied, the water they contained is routed into a cellar beneath the pumping house. This can take a volume of 10 m<sup>3</sup>. From there the water is pumped back up to the high-level tank.

The system is controlled with a tablet PC. All commands are also logged in the control and switchgear station so as to be able to derive improvements for future operation from them. In case of failure there is also an emergency generator available in the switchgear station. Manual operation of the valves is also possible.

## 6 Prospects

By equipping the bed-load barrier with the inflatable weir system and the associated control system, considerably better protection of the town of Schnann is expected next time there is a mudslide. However for this the ecology of the stream requires the flow water to be able to pass, as is now the case under normal flow-off with the inflatable weirs opened.

The long-term aim of the torrent and avalanche containment department is a self-emptying barrier. To this end, experience must be gathered in operation and taken into account with future mudslides. If possible, the degree of automation can also be increased here still further.

### Authors

Ing. Werner Siegele  
TIROLER ROHRE GmbH – TRM  
Innsbrucker Straße 51  
6060 Hall in Tirol/Austria  
Phone: +43 (0)5223/503-108  
E-mail: werner.siegele@trm.at

Dipl.-Ing. Christoph Aigner  
TIROLER ROHRE GmbH – TRM  
Innsbrucker Straße 51  
6060 Hall in Tirol/Austria  
Phone: +43 (0)5223/503-110  
E-mail: christoph.aigner@trm.at

---

**Investing in ductile iron pipe system pays for itself in low installation and operating costs with, at the same time, an extremely long operating life!**

## Guaranteed snow for the ski jumping hill in Planica

By Romana Bohm

### 1 Introduction

Beautiful powdery snow, radiant sunshine and a deep blue sky – that’s the winter idyll pure and simple. Sadly, though, it seems that we can rely on natural snow less and less these days. Therefore a popular winter sports resort relies more and more on the production of technical snow. A reliable supply of water is the basic condition for the functioning of a snow-making system. Meanwhile this has also become a topic in the field of Nordic skiing and even for ski-jumping and ski-flying guaranteed snow is something that people no longer want to do without.

Planica is a resort and also the name of a valley in North-West Slovenia which extends southwards from the village of Rateče, not far from the well-known winter sports centre of Kranjska Gora.

### 2 In Planica ski-jumpers are becoming ski-flyers

The “Letalnica Bratov Gorišek” ski-jumping hill in Planica, constructed in 1969, was for a long time the largest and is currently the second largest ski-jumping hill in the world. After its reconstruction in 2013 jumps of up to 250 m are possible on the hill. For the World Cup ski-jumping and World Championship ski-flying events which take place in Planica, guaranteed snow has highest priority. Since the reconstruction the dream in Planica is that a flight of more than 251.5 m can be achieved. In 2011, ski-flyers landed in a new dimension. In Vikersund in Norway they blasted tonnes of rock out of the mountain to produce the mightiest ski-flying hill in the world.

In summer 2011 work was started on the basic reconstruction of the ski-jumping centre in the “Valley of ski-jumps” at Kranjska Gora. The central objective was to bring the world record back to Planica on the “Letalnica Bratov Gorišek”. The planning for the reconstruction was controlled by Slovenian architect Janez Gorišek, who was involved in the Olympic Games in 1956 and later played a part in building the ski-jumps in Planica (SLO), Oberstdorf (D) and Vikersund (N).

### 3 Choice of material for snow-making on the ski-flying hill

The company TIROLER ROHRE GmbH – TRM has been active in the field of snow-making equipment for decades and supplies robust, reliable and easy-to-handle piping systems which can withstand pressures of up to 100 bar. The VRS®-T restrained push-in joint developed by TRM provides for absolute tightness, even under very high loads. The technical advantages of ductile iron pipes and fittings and their long working life were convincing for the client. The water pipeline for the snow-making system on the “Letalnica Bratov Gorišek” ski-jumping hill is 292 m long. Of this, 105 m are in DN 125 in the lower section (**Figure 1**), 82 m in DN 100 in the middle section and 105 m in DN 80 in the top section (**Figure 2**). Pressures are up to 40 bar.

The greatest difficulty for the KLIMA PTUJ construction company carrying out the work was the extreme steepness of the slope of the ski-jump (up to 60°) with a height difference of 150 m (**Figures 2 and 3**). For this reason an auxiliary hoist was needed for transporting the pipes. The rapid and uncomplicated installation of the ductile iron pipes with VRS®-T push-in



**Figure 1:**  
90° bends incorporated in the restrained design VRS®-T DN 125 ductile iron pipeline in the run-out area of the ski-jumping hill

joints was particularly important in the vertical position in the steep slope. The capacity of the joints to be deflected as much as 5° meant that the pipeline could be ideally adapted to the contours of the terrain and it also saved having to use fittings. The restrained VRS®-T push-in joints also made it possible to install the pipeline above ground. The complete pipeline has been coated with a special UV-resistant external protection developed in the Tyrol.

#### 4 Prospects

The operator and the pipe supplier TIROLER ROHRE GmbH – TRM have designed the pipeline in such a way that it can be used for decades without problem. So far 28 ski-flying world records have been set on the “Letalnica bratov Gorišek” hill in Planica. The snow-making equipment with ductile iron pipes offers guaranteed snow and hence guarantees yet more sporting highlights.



**Figure 2:**  
DN 80 ductile iron pipes – pipeline construction in the area of the starting position



**Figure 3:**  
Ductile iron pipes with restrained VRS®-T push-in joints are part of the snow-making equipment of the Planica ski-jumping hill

#### Author

Romana Bohm [mag.]  
TIROLER ROHRE GmbH – TRM  
Innsbrucker Straße 51  
6060 Hall in Tirol/Austria  
Phone: +43 (0)5223/503-102  
E-mail: romana.bohm@trm.at



## District heating pipeline with water from Lake Geneva in La Tour-de-Peilz (CH)

By Vincent Voyame and Andreas Schütz

### 1 Introduction

With a sustainable energy supply and a reduction in CO<sub>2</sub> emissions in mind, the idea of using heat or cold from lakes is becoming increasingly attractive. In Switzerland around 65 % of the energy used for heating buildings still comes from non-renewable fossil energy sources. Since it is precisely on the larger lakes such as Lakes Constance, Zurich, Lucerne or Geneva that the larger towns and cities also lie, the use of the enormous heating potential of the deep lakes at the edge of the Alps strongly suggests itself. Isolated plants are already in operation, as in Zürich, Lausanne or St. Moritz. But the volumes of heat used to date are small. Also, older heat pumps often have poor efficiency levels. This means that too much energy is used for driving the pumps – for the most

part electrical power but also by combustion engines in the larger plants – for the useful heat actually gained.

### 2 CAD LA TOUR-DE-PEILZ district heating project

The aim of the CAD LA TOUR-DE-PEILZ district heating project is, in the end, to use the energy of the water from Lake Geneva to cover the heating and hot water requirements of around 3,000 households. The technology behind this district heating system combines pumping stations with a network of pipelines and individual heat pumps (**Figure 1**), whereby the energy of the water from Lake Geneva can be used. The water will be taken 500 m from the lake bank and drawn down to a depth of

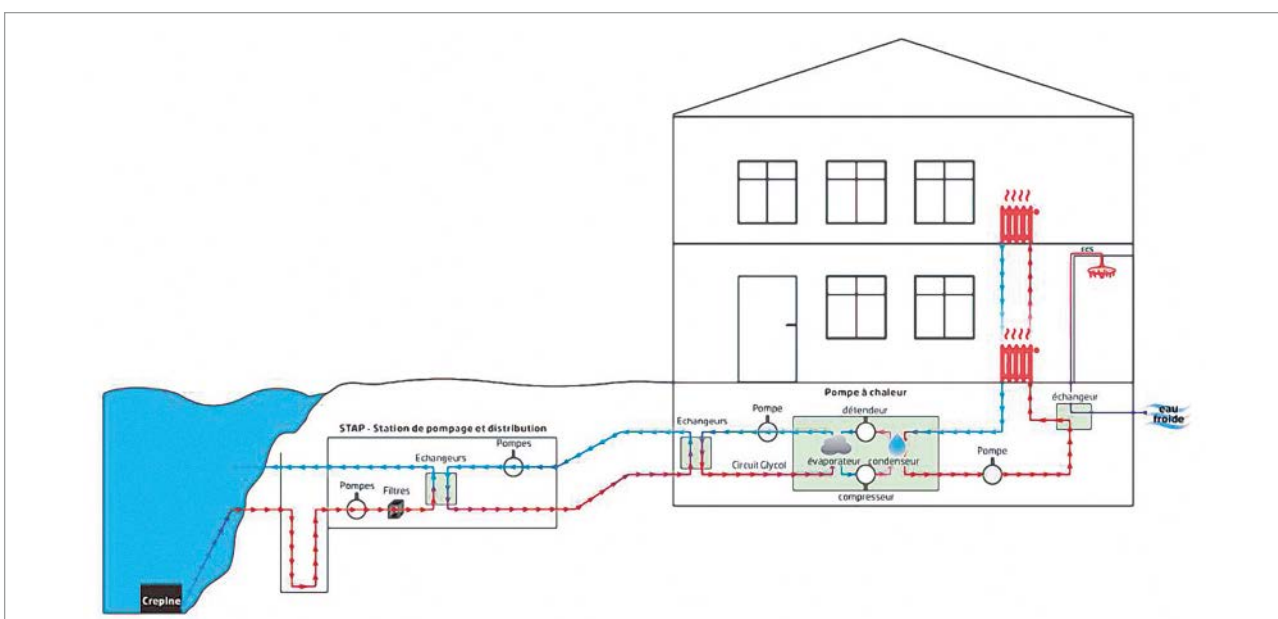
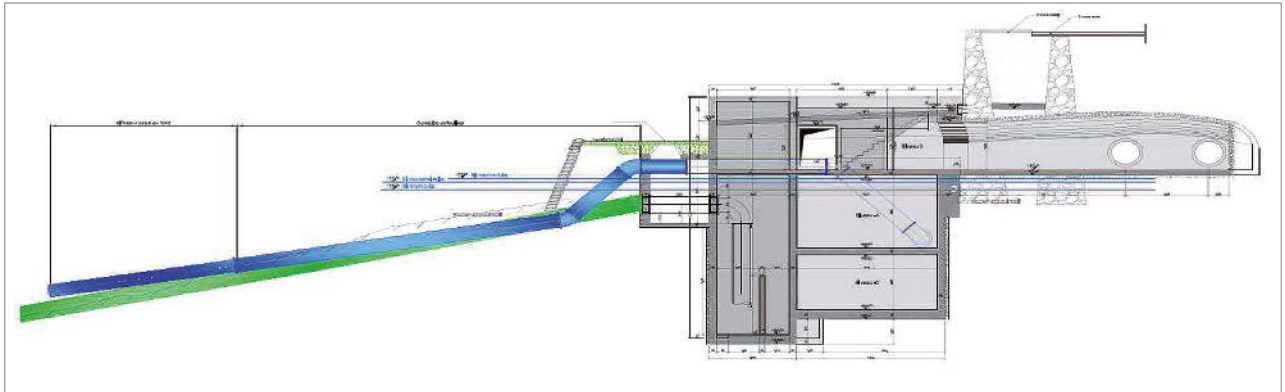

Figure 1:  
The principle of the heat exchanger



**Figure 2:**

Water is carried to a distance of 500 m from the bank of the lake to a depth of 70 m

70 m, where the temperature is stable (**Figure 2**). At a temperature of 6 °C it enters the pumping circuit and delivers 3 K to the distribution network between the pumping station and the buildings connected to the circuit. By alternating compression and expansion the high-performance heat pumps use the energy taken from the lake for heating and for the production of domestic hot water for consumers.

### 3 Great potential for expansion

By the end of 2015 around 15 buildings will be connected to CAD LA TOUR-DE-PEILZ. The network has been designed so that it will grow with the increasing needs of its clients over the course of time, so that in the end it will be supplying more than 300 buildings. By the time the potential is completely taken up, the pumping station will enable a throughput of 3,600 m<sup>3</sup> water per hour to be handled, thereby producing 35,000,000 kWh/a. That corresponds to the average consumption of 3,000 households. By using renewable energies the system will prevent the emission of 10,000 tonnes of CO<sub>2</sub> per year. With an investment of 23.5 million Swiss francs for the first stage, CAD LA TOUR-DE-PEILZ will be one of the largest district heating plants in Europe with this technology. The major technical data on the system are:

- buildings connected: ~ 300
- length of the network: 15 km
- volume of water from the lake: 3,600 m<sup>3</sup>/h
- connected output: 18,500 kW
- energy produced: ~ 35,000,000 kWh/a
- equivalent energy in terms of fuel oil: ~ 3,745,000 litres of fuel oil per year
- CO<sub>2</sub> reduction: ~ 10,000 tonnes of CO<sub>2</sub> per year

### 4 Solution with energy-efficient vonRoll iron pipes

For the construction of piping for district heating, high operational reliability, cost-effective operation and a long working life for the pipeline are decisive criteria for the choice of an appropriate piping system. The von-Roll DUCPUR cast iron pipe with its tried and tested vonRoll HYDROTIGHT thrust resistance system meets these high requirements and was therefore favoured by the project management. The polyurethane-lined pipe, which is produced according to standards EN 545 [1] and EN 15655 [2], has a surface roughness factor of  $k < 0.01$  mm and is thus considered hydraulically smooth in operation. This is a condition required for minimum pressure losses. In addition, because of the thin PUR coating, the hydraulic cross-section of the pipe is comparatively large. Hence this pipe is predestined for a pumping operation where a high energy-related efficiency is crucial as it has a direct influence on the operating costs of the system. Pipes of nominal sizes DN 200 to DN 700 were used in the project.

The district heating pipeline is a closed-circuit system consisting of double pipelines for forward and return flow with inlet and outlet pipelines to the heat exchangers in the buildings. The inlets and outlets of the building connections have been provided with shut-off valves in each case.

As the entire system is several kilometres long, shut-off butterfly valves (**Figure 3**) or gate valves, also coated with epoxy powder, have also been used for isolating sections of the circuit.



**Figure 3:**  
Ready-assembled DN 400 vonRoll shut-off butterfly valves



**Figure 5:**  
DN 700 double pipeline with external thrust resistance (Figure 2806)

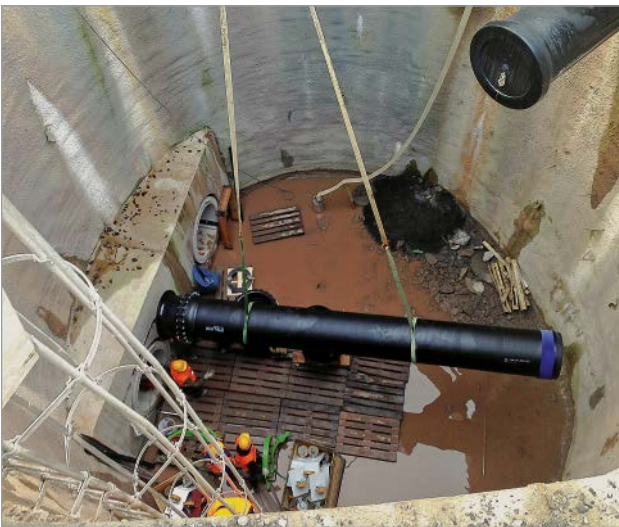

**Figure 4:**  
DN 700 DUCPUR pipe ready for pulling in (concrete micro-tunnel)

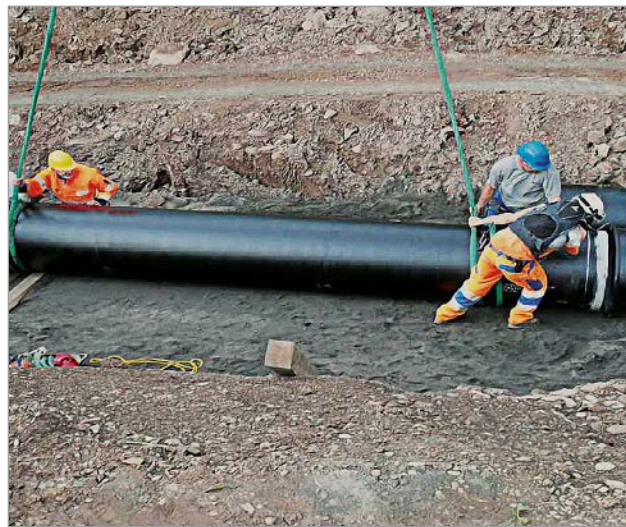

**Figure 6:**  
The vonRoll DUCPUR ductile iron pipes had to be installed by helicopter in some places

Because the space available was restricted in some places, the route of the pipeline was very challenging. So, after the water extraction point on the bank of the lake and directly behind the pumping station, the pipeline had to be run underneath the railway line using the micro-tunnelling process. The DN 700 restrained DUCPUR pipes were pulled into the two tunnels via an 8 m deep shaft using castors (**Figure 4**).

Using the conventional open installation technique, the trench width for the double pipelines (**Figure 5**) was optimised in such a way that installation was possible with one installation unit. Because access to the pipeline route was restricted in some places, a helicopter had

to be used for the transport and installation of the pipes and of components at particularly exposed places (**Figures 6 and 7**).

## 5 Stray current risk when laying pipes underneath a railway line

In the context of the project, the transport pipeline had to run beneath a railway line. In the area of influence of direct-current railways metallic structures in the ground are at risk from stray currents. These stray currents occur because of the reverse current between drive wagons and input rectifier which produces a drop in longitudinal voltage in the rails. These stray currents can considerably endanger a



**Figure 7:**  
flown in by helicopter

longitudinally conductive piping system, i.e. if the electrical resistance of a joint between two pipes is low. The effective interruption of the longitudinal electrical conductivity from pipe to pipe in pipelines of ductile cast iron with pore-free coatings is therefore an important aspect for the aim of achieving as long a working life as possible under these limiting conditions. The new SVGW guideline W4-3 [3] recommends using ductile iron pipes with reinforced coating or, depending on the external protection system, using additional protection with electrically isolating socket joints. Also, in edition no. 06 of Aqua and Gas there is a technical report by the Swiss corrosion protection association (SGK) on corrosion protection concepts for water pipelines [4] which looks at this subject. Potential differences due to different soil conditions necessarily result in a flow of current and hence to accelerated corrosion damage to insufficiently protected metal structures. By using pore-free coated cast iron pipes with electrically isolating socket joints to interrupt the longitudinal conductivity, the possibility of the formation of galvanic elements is greatly reduced. In a series of tests by the SGK lasting three months, the longitudinal electrical conductivity of restrained cast iron pipe systems was recorded using measurement technology equipment. With their high resistance values, vonRoll pipe systems are able to limit possible stray currents [4]. Profiles of the constructions are shown in **Figures 8 and 9.**

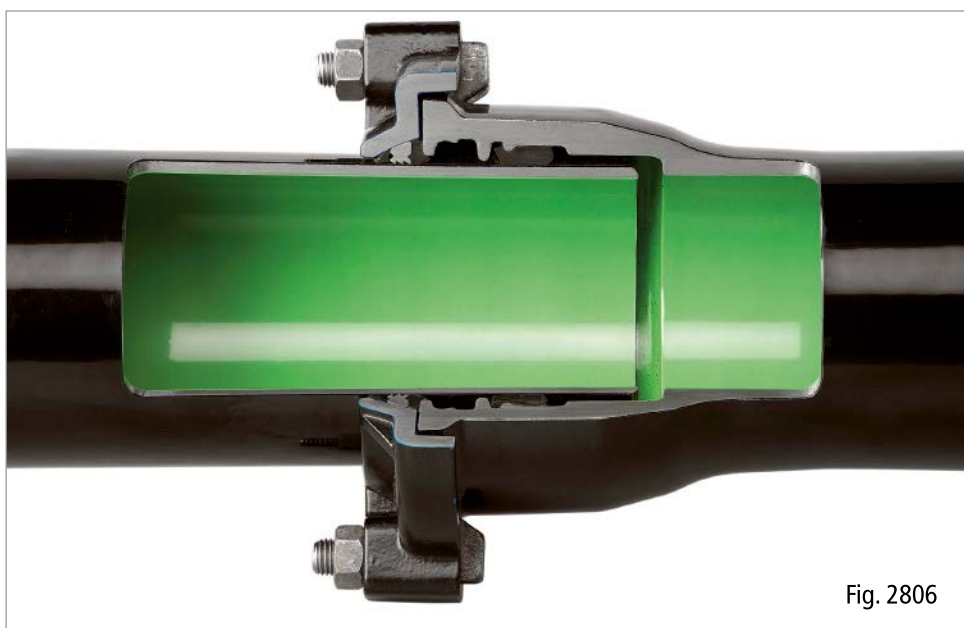

Fig. 2806

**Figure 8:**  
External vonRoll  
HYDROTIGHT thrust  
resistance system  
with high electrical  
resistance for reducing  
longitudinal electrical  
conductivity



Fig. 2807

**Figure 9:**  
Internal vonRoll  
HYDROTIGHT thrust  
resistance system  
with high electrical  
resistance for reducing  
longitudinal electrical  
conductivity

## 6 Conclusion

The pore-free and smooth PUR lining and the large hydraulic cross-section result in a good hydraulic performance for the transport of lake water, significantly reducing the energy consumption of the pumps used. In combination with the vonRoll HYDROTIGHT restrained push-in joints with high electrical resistance, the pore-free PUR coated system is effectively protected against galvanic corrosion and stray currents – a secure investment in the future.

## Bibliography

- [1] EN 545: 2010
- [2] EN 15655: 2009
- [3] SVGW guideline W4-3: 2013
- [4] Aqua & Gas no. 06 Galvanische Elemente: Ihre Gefahren und mögliche Schutzmaßnahmen an Wasserleitungen [Galvanic elements: their risks and possible protection measures on water pipelines] 2013, p. 34 ff.

## Authors

Dipl.-Ing. Vincent Voyame  
vonRoll hydro (suisse) ag  
Von Roll-Strasse 24  
4702 Oensingen/Switzerland  
Phone: +41 (0)62/38812-20  
E-mail: vincent.voyame@vonroll-hydro.ch

Dipl.-Ing. Andreas Schütz  
vonRoll hydro (suisse) ag  
Von Roll-Strasse 24  
4702 Oensingen/Switzerland  
Phone: +41 (0)62/38812-38  
E-mail: andreas.schuetz@vonroll-hydro.ch

## Client

Groupe E SA  
Route de Morat 135  
1763 Granges-Paccot/Switzerland  
Phone: +41 (0)26/3525121  
E-mail: info@groupe-e.ch

## Construction company

YERLY INSTALLATIONS SA  
Z.I. In Riaux 35  
1728 Rossens/Switzerland  
Phone: +41 (0)26/4260070  
E-mail: yerly@yholing.ch

## The planning of pre-insulated cast iron pipelines

By Stephan Hobohm and Karl-Wilhelm Römer

### 1 Introduction

Ductile iron pipes which have been pre-insulated in the factory have been available since the middle of the 1980's. Initially there were also efforts to use these pipes – developed as a system for protecting exposed water pipelines against frost – in district heating pipelines [1]. They did not catch on in this market despite the undisputed technical advantages. By contrast, the pre-insulated pipe system enjoys increasing popularity for frost protection. This is due above all to its really good ease of planning, handling and above-average cost effectiveness.

### 2 The construction of the system

The pre-insulated pipe system consists of socket pipes and fittings (double socket bends, all-socket tees) in ductile cast iron to EN 545 [2] (water) or EN 598 [3] (wastewater). The pipes and fittings are coated with thermal insulation in CFC-free polyurethane (PUR) foam with an average overall gross density of 60 to 80 kg/m<sup>3</sup>. On exposed pipelines, this foam is protected against external influences with folded spiral-seam tubing to EN 1506 [4] in galvanised sheet steel or stainless steel or, for buried pipelines where there is a risk of freezing, with an outer casing in HDPE to EN 253 [5] (**Figure 1**). In the area of push-in joints the gap that is left is filled with a slit ring or a soft polyethylene spiral bandage and then covered with a sheet metal collar in the case of the folded spiral-seam outer tubing or with a shrink-on PE bandage for buried pipelines (**Figure 2**).

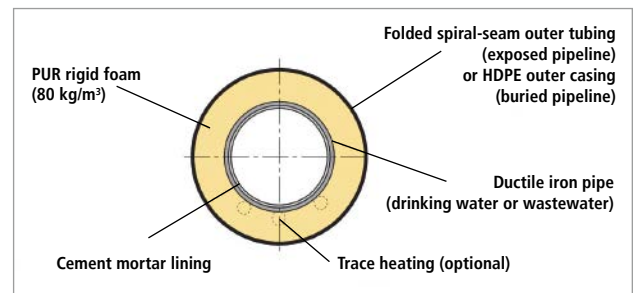

**Figure 1:**  
Cross-section of the pre-insulated pipe system

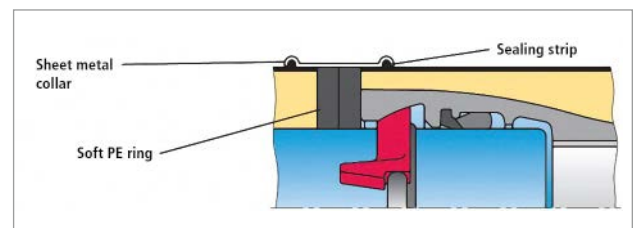

**Figure 2:**  
Subsequent insulation of a pre-insulated pipeline with folded spiral-seam tubes

### 3 How it works

Insulation slows down the heat loss of the transported medium. This means that even quite long stagnation times, especially with smaller diameters, can be endured without the pipeline freezing. The precise lengths of time essentially depend on the ambient temperature, the temperature of the water and the thickness of the insulating layer. **Table 1** gives an initial overview of possible stagnation times. It should be borne in mind here that the times stated relate to an initial temperature of the medium of + 8 °C. Note: halving the initial temperature also entails an approximate halving of the possible stagnation times.

**Table 1:**

Possible stagnation times in a completely filled pipeline above ground – initial temperature 8 °C

Medium pipe DN	Insulation thickness $s_D$ [mm]	Outside temperature – 20 °C		Outside temperature – 30 °C	
		to 0 °C [h]	to 25 % Eis [h]	to 0 °C [h]	to 25 % Eis [h]
80	41,0	10	21	7	14
100	41,0	12	28	9	19
125	40,5	16	39	11	26
150	40,0	20	49	14	32
200	46,5	31	80	22	53
250	63,0	51	135	36	90
300	62,0	62	167	44	111
400	65,5	89	241	63	161
500	89,0	150	410	106	273
600	82,5	172	472	120	315
700	81,0	199	> 500	140	366
800	79,0	224		157	415

**Table 2:**

Possible stagnation times in a buried pipe completely filled – initial temperature 8 °C

Medium pipe DN	Insulation thickness $s_D$ [mm]	max. depth of frost 1.4 m			
		0.3 m cover		0.5 m cover	
		to 0 °C [h]	to 25 % ice [h]	to 0 °C [h]	to 25 % ice [h]
80	41,0	24	68	32	102
100	41,0	31	94	41	142
125	40,5	40	130	53	196
150	40,0	49	169	64	254
200	46,5	76	292	100	440
250	63,0	125	> 500	164	> 500
300	62,0	151		199	
400	65,5	214		282	
500	89,0	447		> 500	
600	82,5	> 500		> 500	
700	81,0				
800	79,0				

Hence lower initial temperatures of the medium reduce the possible stagnation times. Conversely, a greater thickness of the thermal insulation layer or higher external temperatures can extend the possible stagnation time. Nevertheless, if the possible stagnation times are not sufficient, pre-insulated pipes with integral trace heating can be used. By installing heating cables between pipe and thermal insulation the heat loss can be compensated to the extent that a drop in the temperature of the medium is prevented.

As can be seen from **Table 2**, the risk of freezing is considerably lower with a buried pipeline. The possible stagnation times here are many times higher than with an exposed pipeline.

## 4 Planning

When designing a pre-insulated pipeline the following factors, among others, are to be taken into account:

### 4.1 The type of medium

The pre-insulated pipe system is suitable for drinking water, untreated water and wastewater pipelines, but also for extinguishing and process water pipelines. The linings are to be selected accordingly (mortar based on blast-furnace cement for drinking water, untreated water and extinguishing water pipelines; high-alumina cement for wastewater, if applicable also for untreated water; special linings for other application cases). Medium and initial temperature influence the achievable stagnation times: if the initial temperatures are higher than or equal to + 8 °C, **Tables 1 and 2** can be applied – the stagnation times stated are on the safe side. In the case of lower temperatures, different considerations should be applied. As a rule of thumb: half the initial temperature = half the possible stagnation time. More precise calculations can be obtained from the technical departments of the cast iron pipe manufacturer. With drinking water pipelines the pre-insulated pipe system can be used in order to avoid an unacceptable temperature increase during the summer months.

### 4.2 The location of the pipeline

A distinction is to be made here between buried pipelines and exposed pipelines (pipelines laid above ground, e.g. across bridges). **Table 1** shows the possible stagnation times for an exposed pipeline. The temperature drop here is caused not only by very low outside temperatures but also by the wind. Buried pipelines in an area subject to frost, on the other hand, are at considerably lower risk because the earth has an insulating effect here (**Table 2**). If freezing of the pipeline cannot be excluded (the possible stagnation times are exceeded), the first thing to think about is increasing the thickness of the insulating layer, taking account of the external diameter.

### 4.3 The external diameter

The catalogues of cast iron pipe manufacturers usually state the standard external diameter  $D_a$  of the pre-insulated pipe (**Table 3**). However, the external diameter of the outer casing can vary depending on the type of joint of the pipe or fitting (**Figure 3**). In nominal sizes DN 80 to DN 150, for example, there are differences between pre-insulated pipes with TYTON® or BLS® push-in joints. It is essential that these differences are taken into account when designing a wall penetration or the size of brackets for pipe suspension.

**Table 3:**  
Technical data for a pre-insulated pipe with BLS® push-in

DN	Dimensions [mm]				Weight [kg] ~ <sup>1)</sup>	
	$\varnothing D_a$	$\varnothing d_i$	L	$s_b$	exposed pipe	buried pipe
80	180	98	207	41,0	121	110
100	225	118	215	53,5	149	140
125	250	144	223	53,0	180	171
150	280	170	230	55,0	212	204
200	355	222	240	66,5	300	288
250	400	274	265	63,0	383	378
300	450	326	270	62,0	476	471
400	560	429	290	65,5	705	715
500	710	532	300	89,0	986	1,003
600	800	635	280	82,5	1,266	1,314
700	900	738	302	81,0	1,632	1,698
800	1,000	842	314	79,0	2,004	2,082

<sup>1)</sup> total weight, other nominal sizes, insulation layer thicknesses and trace heating on request.



**Table 4:**  
Possible external diameter of pre-insulated pipes

Possible nominal external diameter of pre-insulated casing tubes in mm																
180	200	225	250	280	310	355	400	450	500	560	630	710	800	900	1,000	1,100

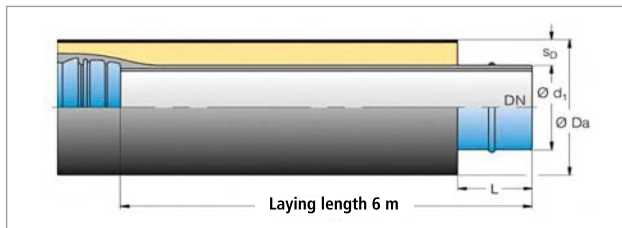

**Figure 3:**  
Dependency of external diameter  $D_a$  of a pre-insulated pipe on the type of push-in joint

Depending on the external conditions and the stagnation time required, the external diameter of the casing tube and hence the thickness of the insulation layer can be gradually enlarged. The possible external diameters correspond to EN 1506 [4] or EN 253 [5]. Table 4 shows a selection of possible nominal external diameters. When choosing the diameter of the casing tube, the external diameter of the socket is to be taken into account. The cast iron pipe manufacturer's application engineers can help with the determination of longer stagnation times.

#### 4.4 Heating

If, for reasons of space, the external diameter cannot be increased, the integration of trace heating has to be considered. It is crucial that this is taken into account in the planning phase. The subsequent installation of heating cables is not possible.

For trace heating, up to three self-regulating heating cables are affixed to the pipe carrying the medium and then the whole thing is covered in foam in the casing pipe. The cables protrude some 15 cm to 20 cm at the ends of the thermal insulation and are later connected together once the pipe has been assembled using press-fit connectors and shrink-on sleeves. Depending on the wattage (usually between 10 W/m and 30 W/m) and electrical protection, a heating circuit length of 50 m to 150 m per cable can be achieved.

There are solutions available at various pricing levels for controlling the heating cables. In addition to simple control by means of thermostats with large tolerances and little in the way of adjustment, remote control or monitoring possibilities, there are also some more expensive control systems to be found (e.g. Bartec or Raychem brands). Such systems can for example control more than one heating circuit, determine minimum and maximum temperatures and transmit alarms. High-quality controls of this type also have external thermostats which can pick up the temperature directly at the pipe and so work very precisely, thereby saving energy.

The technical advice of the cast iron pipe manufacturer should be taken into account right from the planning stage for an optimal design of trace heating and control.

#### 4.5 Material of the outer casing

The casing for the thermal insulation needs to be selected according to whether an exposed pipeline (Figure 4) or a buried pipeline (Figure 5) is planned. The following are available:

- folded spiral-seam sheet in galvanised steel,
- folded spiral-seam sheet in stainless steel (1.4571 – V4A),
- PE outer casing (black),
- special solutions with steel pipe.



**Figure 4:**  
Exposed pipeline with folded spiral-seam outer tubing in stainless steel



**Figure 5:**  
Pipes for installation underground with PE outer casing



**Figure 6:**  
Support distance = pipe length = 6 m



**Figure 7:**  
Support to the left and right of a fitting

For exposed pipelines, e.g. on or under bridges, folded spiral-seam tubes are usually used. The reasons for this are above all a good optical appearance, excellent UV resistance and, because of the reflecting surface, a low level of heating due to solar radiation in the summer.

On the other hand, pre-insulated pipes with HDPE casings are preferable for buried pipelines in areas where there is a risk of frost. The grain size of the bedding materials used must correspond to Annex G of DVGW worksheet W 400-2 [6]. In addition to the conventional types of casing tubes mentioned, alternative casing materials can also be used such as steel pipes. This may be necessary for static reasons, for example, with very shallow cover depths under roads.

#### 4.6 Pipe statics

With low depths of earth cover  $< 0.5$  m under surfaces crossed by traffic there is the risk that the casing tube and the PUR hard foam will become deformed. There are various possibilities available to avoid subsidence:

- casing tube in a static load-bearing material (e.g. steel pipe),
- load distributing plates above the pre-insulated pipe,
- self-supporting concrete jacket, e.g. as per DWA worksheet A 139 [7].

Exposed pipelines are suspended from brackets or laid on cross-supports.

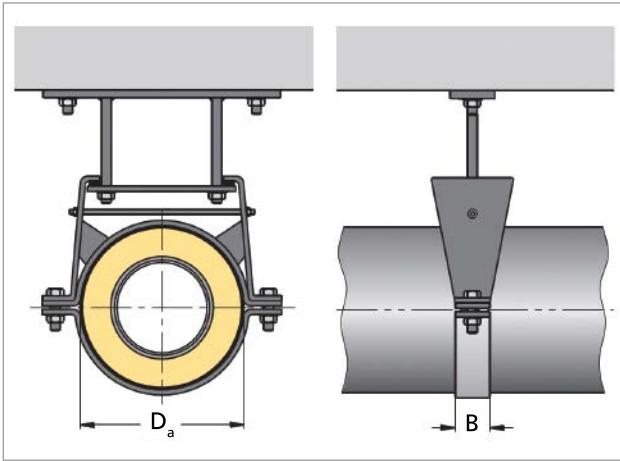

**Figure 8:**  
Bracket diameter  $D_a$  and bracket width  $B$



**Figure 9:**  
Rubber interfaces between folded spiral-seam outer tube and bearing

**Table 5:**  
Minimum bracket width  $B$  [mm] for a distance of 6 m (pipe length)

DN	80–125	150–200	250–300	400–500	600–700	800
B	100	150	200	300	400	450

#### 4.7 Suspensions/supports

Because of the high longitudinal rigidity of cast iron pipes it is usually enough to provide just one support per pipe (**Figure 6**). It is positioned approximately 0.5 m to 1 m behind each socket. With fittings (e.g. double-socket tees for vents and hydrants) a support is to be provided on either side of them (**Figure 7**).

The width of the support depends on the nominal diameter and hence the weight of the pipe. The various manufacturers recommend slightly different minimum bracket widths (**Figure 8**). **Table 5** gives a summary of possible bracket widths for a distance of 6 m (pipe length). With shorter distances the bracket width can be reduced.

In order to avoid mechanical damage to the folded spiral-seam outer tube and possible potential differences between casing tube and bracket, rubber interfaces should be provided. The material thickness of the rubber pads is usually about 5 mm (**Figure 9**).

The construction of the support or suspension plays a central role in the design of exposed pipelines. There are differences here between:

- slide bearings,
- fixed bearings,
- fixed points.

The choice between these possibilities depends on the type of joint of the pipe system and the construction of the bridge. Basically it is recommended that slide bearings are used, meaning that the pipeline is independent of movements of the bridge or the structure in question. Under thermal influences bridges are more susceptible to expansion or contraction than pre-insulated pipelines which are constantly filled with water and, of course, insulated. In order to avoid unintended movements of the flexible pipe string (e.g. due to pressure surges), at least one fixed point should be provided in the pipe run, the position of which should coincide with the fixed point of the bridge wherever possible. However, the combination of fixed point and slide bearings does mean that pipes and fittings with positive locking joints must be used (e.g. BLS® push-in joints).

When non-restrained joints are used such as TYTON® push-in joints, fixed bearings are to be provided for each pipe. The pipes are thus firmly attached to the structure and take up all

movements. These movements are to be taken into account when designing and assembling the push-in joints.

#### 4.8 Types of joint

Ductile iron pipes and fittings are available with different types of joint. These take the form of non-restrained push-in joints (e.g. TYTON®), restrained friction locking push-in joints (e.g. BRS®) and restrained positive locking push-in joints (e.g. BLS®). The first two types of joint should, wherever possible, be used exclusively for buried pipelines. The use of such joints in exposed pipelines should be avoided and only considered in exceptional cases agreed in advance with the pipe manufacturer. For non-buried pressure pipelines (e.g. on bridges, beams or in buildings) a positive locking push-in joint, such as the BLS® push-in joint, is strongly to be advised.

#### 4.9 Miscellaneous

In addition to the factors already mentioned, the following points should also be taken into account in the planning:

- Only all socket fittings can be insulated in the factory. Flanged fittings or pipes must be insulated on site. In the case of trace heating, a corresponding volume of additional heating cables and connection sets should be included in the planning.
- Folded spiral-seam tubes can be produced with internal or external seams. The external seam is standard. If, because of a smooth external contour, an internal seam is desired, this must be taken into account when planning and ordering.
- In most cases, high points in the pipe run are associated with pipelines on bridges. According to DVGW datasheet W 334 [8] in certain cases aeration and/or ventilation possibilities need to be provided for. In order to produce an interface to a suitable valve, either branch fittings such as double-socket tees with flanged branch (**Figure 7**) or a 1" to 2" threaded female outlet integrated into the pipe in the factory which is capable of being shut off can be envisaged (**Figure 10**).

Branch fittings must be insulated on site and the position of outlets to be produced in the factory must be determined in the planning phase.

- Expansion joints are only necessary for thermally insulated cast iron pipelines in exceptional cases. This is due above all to the very low thermally-related change in length because of the coefficient of thermal expansion of cast iron of only  $10 \cdot 10^{-6} \text{ m}/(\text{m} \cdot \text{K})$ . Added to this is the fact that the thermal insulation and the filling of the pipeline with water reduce possible temperature fluctuations still further. Nevertheless, any length changes which occur are taken up by the sockets and angular deflections in the sockets of bends. However, operating conditions may also arise which make an expansion joint necessary. It is conceivable that the pipeline may be taken out of operation in summer or in winter, when the compensating effect of the medium flowing through it is reduced.
- Masonry and wall penetrations are usually closed with ring seals.
- When tightening the screws for affixing the seal, care must be taken to avoid denting the pipe casing.



**Figure 10:** 1.5" threaded female outlet insulated in the factory with shut off capability and ventilation valve with thermal insulation

## 5 Construction work

Thermally insulated cast iron pipes are packed individually rather than being delivered in bundles. They should not be unloaded with chains or other lifting tackle which might dent the casing. By preference handling hooks in the socket end and spigot end or else wide, rubberised forks are to be used. They should be stored on square timbers at least 10 cm wide and these should be padded if possible. Stacking the pipes is to be avoided.

Special assembly equipment can be obtained from the relevant pipe manufacturer. Belts in combination with chain hoists are also possible. It is crucial that any denting of the casing is avoided.

As already described, folded spiral-seam casing tubes are primarily designed for use with exposed pipelines above ground. However it is not always possible to avoid having these pipes running underground. A typical situation is, for example, when they have to go through bridge abutments. Here it is practically unavoidable that the spiral casing ends up in the ground. In such a case it is advisable that the spiral casing should be additionally protected by shrink-on sleeves, petrolatum bandages, protective tape or fleece.

The heating cables for trace heating must lie in the bottom of the pipe. If such a pipe needs to be cut, particular attention must be paid not to damage these cables. The pipe manufacturer's instructions should be followed for the correct way to cut pre-insulated pipes. The heating is to be installed by an electrician.

After the assembly of the pipeline and if applicable the connection sets for the heating cable, the socket transitions still have to be insulated. Special insulating sets are supplied by the pipe manufacturers for this purpose. They consist of insulating material and sheet metal or shrink-on collars. In no case should "spray foam" or similar be used for insulating the socket transitions.

## 6 Conclusion

Pre-insulated pipe systems are an excellent way of producing thermally insulated pipelines. If the points discussed above are taken into account during planning and construction there is nothing to stand in the way of fast and cost-effective implementation. However, because of the complexity it is always advisable to ask for technical support from the pipe manufacturer's applications team. Particularly on questions of the right type of joint in combination with the design of the ideal bracket and support system and the necessity of calculating dimensions for trace heating, a pool of experience is a definite requirement.

### Bibliography

- [1] Hein, H.  
GUSSROHR-TECHNIK  
[CAST IRON PIPE TECHNOLOGY]  
FGR Issue 22 (1987), p. 51 ff.  
Download: [www.eadips.org/jahreshefte-d/](http://www.eadips.org/jahreshefte-d/)
- [2] EN 545: 2010
- [3] EN 598: 2007+A1:2009
- [4] EN 1506: 2007
- [5] EN 253: 2009+A2:2015
- [6] DVGW worksheet W 400-2: 2004-09
- [7] DWA worksheet A 139: 2009-10
- [8] DVGW data sheet W 334: 2007-10

### Authors

Dipl.-Ing. (FH) Stephan Hobohm  
Duktus Rohrsysteme Wetzlar GmbH  
Sophienstraße 52–54  
35576 Wetzlar /Germany  
Phone: +49 (0)6441/49-1248  
E-mail: [stephan.hobohm@duktus.com](mailto:stephan.hobohm@duktus.com)

Karl-Wilhelm Römer  
Duktus Rohrsysteme Wetzlar GmbH  
Schweinsbühl, Kerbelweg 6  
34519 Diemelsee /Germany  
Phone: +49 (0)5632/922252  
E-mail: [Karl-Wilhelm.Roemer@duktus.com](mailto:Karl-Wilhelm.Roemer@duktus.com)

### Picture credits

Except where otherwise stated, the pictures appearing in the text were supplied by the authors.

### Layout and production

schneider.media

### Published by and copyright

European Association for Ductile Iron  
Pipe Systems · EADIPS®/  
Fachgemeinschaft Guss-Rohrsysteme  
(FGR®) e.V.  
Im Leuschnerpark 4  
64347 Griesheim/Germany

Phone: +49 (0)61 55 / 6 05-2 25  
Telefax: +49 (0)61 55 / 6 05-2 26  
E-mail: r.moisa@eadips.org

### Editor

Dipl.-Ing. Raimund Moisa

### Press date

20 January 2016

Text may be reprinted provided the source is acknowledged.  
Please supply a specimen copy.

[www.eadips.org](http://www.eadips.org)



Figure 1:  
QR code for EADIPS®/FGR® - website

### Disclaimer

Whilst every care has been taken in the compilation of the material, information and content contained in this Annual Journal, and every effort is made to ensure that it is both accurate and up-to-date, the EADIPS®/FGR® makes no representations or warranties of any kind, express or implied, about the completeness, correctness, up-to-dateness or technical accuracy of such material, information and content. Whilst all reasonable steps have been taken to ensure that this Annual Journal is free from computer viruses, we accept no liability in respect of any loss, cost, damage, inconvenience or expense suffered as a result of accessing this Annual Journal. We also reserve the right to make, at any time and without prior notice, amendments or additions to or deletions from the material, information and content contained in this Annual Journal.

Through this Annual Journal you are able to access links to third-party websites which are not under the control of the EADIPS®/FGR®. We have no control over the nature and content of these third-party websites or over any changes made to them. We therefore accept no liability for the content of such third-party websites to which links are provided in our Annual Journal, or for links to further websites which are provided on such third-party websites.

### Reproduction

Text, data, software and graphics appearing in this Annual Journal may be reprinted, reproduced, copied or used in other ways for non-commercial, private, education or training-related purposes provided always that the text, data, software and graphics are not modified and that an indication that the EADIPS®/FGR® is the copyright owner appears on every copy. Prior written consent must be obtained from us for any other use.

---

Logos of full members of the EADIPS®/FGR®

---

**Düker**

**KEULA**  
hütte

**VAG**

**DUKTUS**

**FRISCHHUT** RANGE

**vonRoll**hydro

vonRoll hydro (deutschland) gmbh

**ERHARD**  
BY TALIS

**TIROLER ROHRE**

**vonRoll**hydro

vonRoll hydro (suisse) ag

---

Logos of sponsoring members of the EADIPS®/FGR®

---

**AkzoNobel**

**SAINT-GOBAIN**  
BUILDING DISTRIBUTION

**REF TBU**

**FRIEDRICHSHÜTTE**

**SATTEC DBS**  
gamma

**Wendel** Email

**MFG**

**HAGENBUCHER**

**WLB**  
ROHRE+ARMATUREN

**KONTINENTALE**  
Die reine Kompetenz

**Tröger + Entenmann**  
**Ferrum**  
Handel  
**TE**

**PSC**  
Mitglied der Woco Gruppe

**HTI** **GC GRUPPE**



**EADIPS®**  
**FGR®**

**European Association for  
Ductile Iron Pipe Systems**

Fachgemeinschaft Guss-Rohrsysteme

