

DUCTILE IRON PIPE SYSTEMS

The Annual Journal of the European Association for Ductile Iron Pipe Systems • EADIPS®

47



Sustainably superior –
ductile iron pipe systems

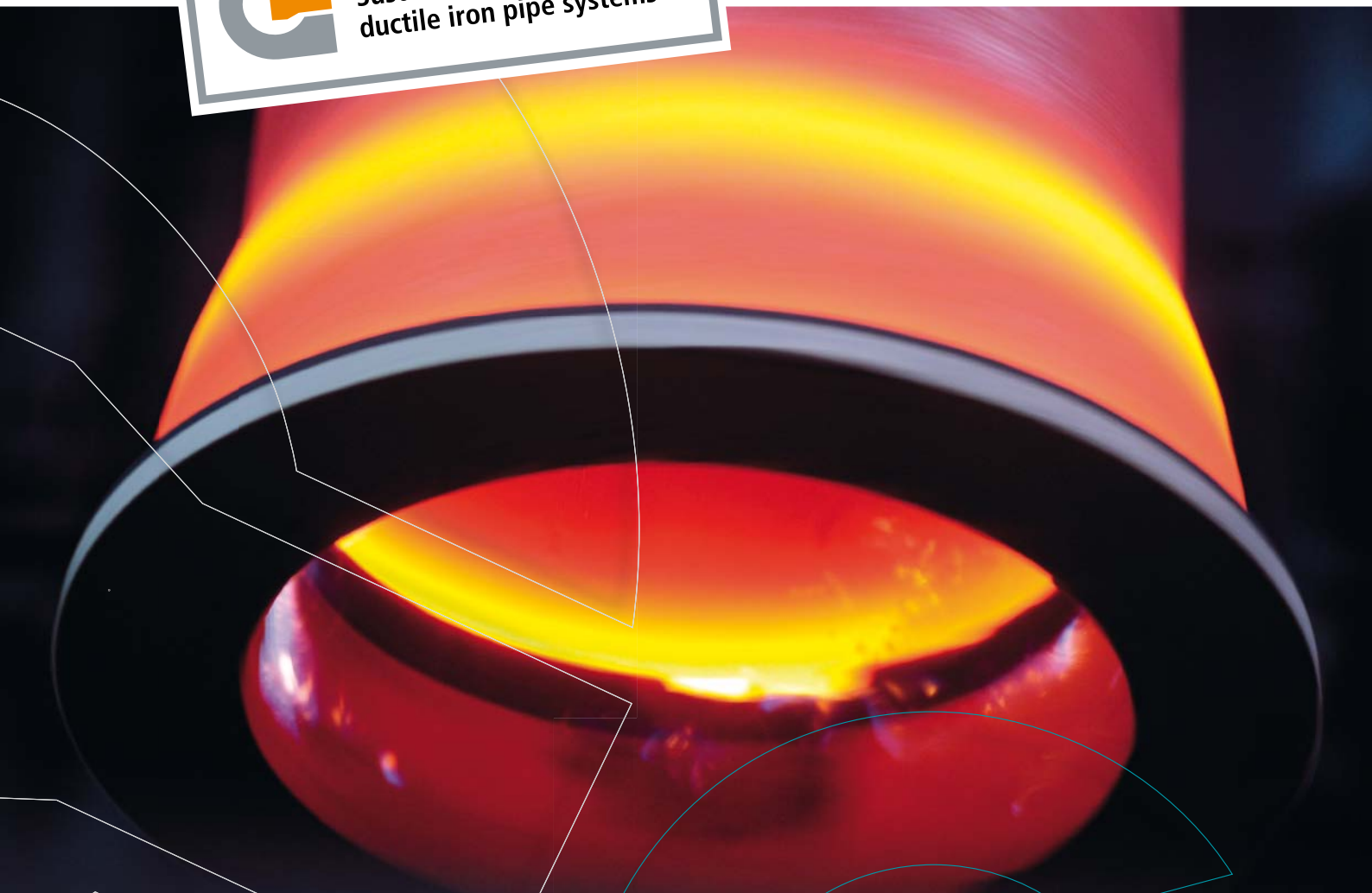

- 4 Letter from the editor
- 5 Abstracts
- 8 Sustainability criteria for ductile iron pipe systems
Sustainably superior – ductile iron pipe systems
- 10 Laying of new DN 80 to DN 200 water pipelines
Albania needs pipelines for drinking water – the first soft loan project in Albania
by Andreas Weiler and Claudia Mair
- 13 Replacement of valves and fittings
Pipe runs rehabilitated for the Aggerverband supply utility by replacing valves and fittings
by Dieter Wonka, Klaus Eisenhuth and Martin Herker
- 16 DN 200 pipeline for fire-fighting water
Zurich's Durchmesserlinie cross-city rail link – an XL size mega project
by Steffen Ertelt
- 20 DN 300 and DN 500 water mains
Water mains in Lucerne's Sonnenberg and Reussport autobahn tunnels
by Roger Saner
- 28 DN 80 pillar hydrants
Pillar hydrants for the fire-fighting system in the Jagdberg tunnel
by Petra Klingebiel
- 30 DN 400, PFA 40 penstock pipeline
Replacement of the pressure pipeline to Giessbach power station on Lake Brienz
by Wolfgang Rink
- 34 DN 500 and DN 600 penstock pipelines
Penstock pipelines for small hydroelectric power stations in the Alpine region
by Andreas Moser
- 39 DN 500 and DN 600 pipelines for power stations
Electricity from water power
Ductile iron pipelines for power stations – important components for generating renewable energy
by Wolfgang Rink

- 44** **The horizontal direction drilling technique at DN 300**
Installation of a DN 300 drinking water pipeline
by the HDD technique – compulsory retirement
for a pipeline bridge crossing a river
by Marc Winheim
- 48** **The horizontal direction drilling technique at DN 500**
Horizontal directional drilling with ductile iron pipes –
process description, advantages, fields of application, examples
by Stephan Hobohm
- 58** **Pipe relining at DN 400**
Trenchless rehabilitation by pipe relining
Replacement of the HW 1.1 DN 700 water main between
Hattersheim and the Sindlingen district of Frankfurt
by Alexander Scholz
- 63** **Burst lining at DN 400**
A record for the burst lining technique in Austria
A DN 400 drinking water pipeline of ductile iron pipes
pulled in trenchlessly in Linz
by Stefan Koncilia
- 67** **Pre-insulated ductile iron pipes**
A wide range of practical applications
for pre-insulated ductile iron pipes
by Lutz Rau
- 75** **EADIPS®/FGR® – 2012 Conference for College and University Teachers in Zurich**
Applications of ductile iron pipe systems
in the energy and water industries
by Jürgen Rammelsberg
- 79** **Imprint**
- 80** **Logos of full members of the EADIPS®/FGR®**
Logos of sponsoring members of the EADIPS®/FGR®
- 81** **About us**
The EADIPS®/FGR® Standards Database

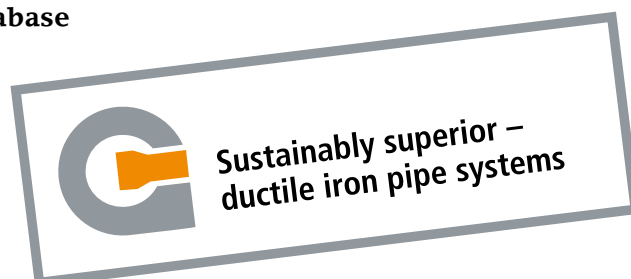



Dear readers,

The European Association for Ductile Iron Pipe Systems (EADIPS®) is an association devoted to promoting the interests of European manufacturers of ductile iron pipes, fittings and valves. The Association also operates under the German name Fachgemeinschaft Guss-Rohrsysteme (FGR®) e. V. To strengthen the Association's Europe-oriented thinking, it has been given a new logo in the corporate typeface. Publications, training documents and advertising and publicity material have been carrying the new logo in the corporate typeface since 1 October 2012.



In this 47th issue of the Association's Journal, we would once again like to present to you some of the completed pipeline projects on which ductile iron pipes, fittings and valves have been used. These include new pipelines which have been laid for drinking water and fire-extinguishing water.

Another article describes the rehabilitation with replacement of fittings and valves. Some of the other main topics dealt with in our articles are the laying of pipelines for power stations, trenchless installation techniques and the use of pre-insulated ductile iron pipes. The articles in issue 47 conclude with a report on our 2012 Conference for College and University Teachers in Zurich. The theme which emerges from all the articles is **sustainability**. The ways in which they each relate to this subject are brought together as key points in the article entitled "Sustainably superior – ductile iron pipe systems".

I hope you will find plenty to enjoy in the new 47th issue of **DUCTILE IRON PIPE SYSTEMS**.

A handwritten signature in blue ink, which appears to read 'Raimund Moisa'.

Yours sincerely,
Raimund Moisa

**Albania needs pipelines for drinking water –
The first soft loan project in Albania***Andreas Weiler and Claudia Mair* 10

New solutions to the problem of financing regional infrastructure projects in developing countries are opening the way to sustainable social and economic development in Albania. This is an illustration of how low-interest government loans are laying the foundations for former socialist countries to develop to the general European level. The example of a small Albanian town with a decrepit water supply system is taken to show how the Austrian Ministry of Finance is contributing to regional development by making available the low-interest loans known as soft loans. And if there is a sustainable water supply system, it goes without saying that ductile iron pipe systems are part of it.

**Pipe runs rehabilitated for the Aggerverband
supply utility by replacing valves and fittings***Dieter Wonka, Klaus Eisenhuth and
Martin Herker* 13

Ductile iron fittings are things that often lead a rather shadowy existence compared with pipes. Here however is a case where they had a leading role to play in the rehabilitation and restructuring of manholes holding valves and distributors. There were times when the supplier's flexibility was put to the test when tailor-made specials were needed in a manhole. The quality standards which the coating of powdered epoxy resin had to meet were very demanding.

**Zürich's Durchmesserlinie cross-city rail link –
an XL size mega project***Steffen Ertelt* 16

Ductile iron pipes for fire-fighting water pipelines – a field of application in industrial plants and road and railway tunnels where these pipes have been a success for decades. A primary concern of Swiss Federal Railways is extreme safety, so the company is following the latest specifications and is installing very safe fire protection systems in Zurich's new station tunnel, using of course ductile iron pipes!

**Water mains in Lucerne's Sonnenberg
and Reussport autobahn tunnels***Roger Saner* 20

40-year-old autobahn tunnels on the European main North-South traffic route in Lucerne are having to be renovated to bring them into line with the greater volume of traffic and with more stringent safety requirements. Back then they were laid in the carriageways but now they are being installed in dedicated, newly bored, services tunnels – a very complicated undertaking given the existing geological constraints. Ductile iron pipes systems are an elegant and sustainable solution to problems of this kind.

**Pillar hydrants for the fire-fighting system
in the Jagdberg tunnel***Petra Klingebiel* 28

It is almost inconceivable nowadays for fire protection systems in road tunnels not to use ductile iron pipe systems. The pipelines consist of pipes, fittings and valves and at the take-off points for the fire-fighting water they need hydrants. In the case of the Jagdberg tunnel on Federal Autobahn 4 near Jena in Thuringia in Germany, these hydrants take the form of self-draining pillar hydrants.

**Replacement of the pressure pipeline to Giessbach
power station on Lake Brienz***Wolfgang Rink* 30

An existing penstock pipeline needed to be replaced in double-quick time because a fire in the transformer building had upset all the planning, including the intended increase in output, but it nevertheless had to be ensured that the breakdown in electricity generation was only minimal. What was therefore needed was the utmost flexibility from the planners, the pipeline installer and the pipe manufacturer, a challenge that could be met supremely well with ductile iron pipe systems. The technical problems in laying the penstock pipeline were enormous, but steel brackets anchored in the rock acted as fixed points for the thermally insulated above ground part of the pipeline. Fixed points were also used to secure the buried part of the pipeline on a steep slope.

Penstock pipelines for small hydroelectric power stations in the Alpine region

Andreas Moser 34

Here once again is evidence of the preferred approach that is adopted in the Alpine region when it is a question of generating electricity in small hydroelectric power stations for the communities in the region. When sophisticated technical solutions are needed for installing the penstock pipelines required in the rocky terrain, ductile iron pipe systems will solve absolutely all the problems. There are two special features in this case. Firstly, the generation of renewable energy is something that has to be done to increase sustainability in the energy field and secondly ductile iron pipe systems, because of their durability, safety and good energy balance, do their bit to allow resources to be managed sustainably.

Ductile iron pipelines for power stations – important components for generating renewable energy

Wolfgang Rink 39

Four penstock pipelines in four different Swiss projects for small hydroelectric power stations: what they have in common and what, in the truest sense of the word, connects them are DN 500 and DN 600 ductile iron pressure pipes of wall thickness classes K 9 to K 14 with BLS® type restrained joints and cement external mortar coating. Transport and handling by helicopter in inaccessible terrain, bedding of the pipes in rocky excavated material and laying in a steep rock wall were the challenges the men of the installing company had to contend with. It gave ductile iron pipe systems a chance to show their sustainable superiority!

Installation of a DN 300 drinking water pipeline by the HDD technique – compulsory retirement for a pipeline bridge crossing a river

Marc Winheim 44

A dilapidated footbridge over the river Marne had been closed to pedestrians but for some decades it had carried a DN 300 cast iron drinking water pipeline, whose safety had now itself become questionable. There was no question of a new footbridge being built so a new drinking water pipeline of DN 300 ductile iron pipes was installed under the Marne by the HDD technique. This killed two birds with one stone:

the installation technique was very economical and the advantage of the consistently low temperature of a buried pipeline was automatically obtained.

Horizontal directional drilling with ductile iron pipes – process description, advantages, fields of application, examples

Stephan Hobohm 48

The current status of the HDD technique when ductile iron pipes are used is described by reference to some practical examples and to the ongoing development of the technical rules. Over a period of 20 years, the limits of the technique have been advanced from a cautious 60 m of DN 150 to 500 m of DN 900, which is thought to be a record. When assembled one by one, ductile iron pipes are able to show all their advantages thanks to the fast and safe way in which they can be connected by positive locking push-in joints – so it's no wonder that the HDD technique with ductile iron pipes is becoming more and more of a favourite.

Replacement of the HW 1.1 DN 700 water main between Hattersheim and the Sindlingen district of Frankfurt

Alexander Scholz 58

Water mains which were installed in towns and cities 100 years ago are showing increasingly frequent damage and are becoming a nightmare for the people responsible in water supply companies. In Frankfurt am Main they have quickly gained experience of trenchless replacement, one result they have seen of the drop in demand for water being smaller cross-sections for pipelines. This has turned pipe relining in the old mains into the preferred technique for replacement given the very low cost and complication of the underground work. Word has spread of the good experience they have had with the rugged and sustainable ductile iron systems: a similar procedure is being adopted in many other towns and cities because of the superiority of the technique and how it pays off in economic terms.

A DN 400 drinking water pipeline of ductile iron pipes pulled in trenchlessly in Linz

Stefan Koncilia 63

It's easy to see how trenchless installation and replacement techniques are developing from the records that have been tumbling: an old DN 400 pipeline of grey cast iron has been replaced with ductile iron pipes of the same

diameter by the burst lining technique on Linz's premier shopping street. This is a new record for this technique in Austria. The alternative open trench technique would have meant some weeks of disturbance for businesses and shoppers and a temporary suspension of services on the tram line.

A wide range of practical applications for pre-insulated ductile iron pipes

Lutz Rau67

For decades now ductile iron pipes with thermal insulation have been used for water pipelines at risk of freezing. This article is a wide-ranging collection of examples of highly diverse applications and explains the fundamentals of planning for the installation of water pipelines in road tunnels and on bridges and at locks, i.e. anywhere where the constant temperatures typical of buried pipelines are not present.

Applications of ductile iron pipe systems in the energy and water industries

Jürgen Rammelsberg75

In April 2012, EADIPS®/FGR® was host in Zurich for an event for college and university teachers organised in the FIHB specialising in the water industry, supply technology and installation. This event allowed them to learn about the latest applications, installation techniques and material properties of ductile iron pipe systems. Zurich was an illustration of the international nature of the EADIPS®/FGR®, its Swiss member vonRoll hydro (suisse) ag also has its headquarters nearby. Papers were given and the event was managed under the aegis of Wasserversorgung Zürich.

Sustainably superior – ductile iron pipe systems

In 2012, the EADIPS®/FGR® and its member companies organised a campaign to assess the sustainability of ductile iron pipe systems – pipes, fittings and valves – under the slogan

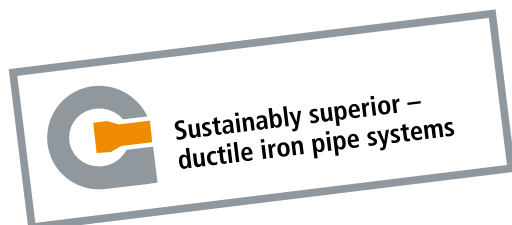

The sustainability criteria for assessing them from the environmental, economic and technical points of view were made public to professionals in the pipe system field (at fairs, exhibitions, congresses, annual conferences, training courses, lectures, etc.) and are shown as bullet points in **charts 1, 2 and 3**.

Taking the sustainability criteria for ductile iron pipe systems which are specified in **charts 1, 2 and 3**, we leave it to the readers of this Journal to consider the articles published in it from these points of view.

Chart 1:
Environmental sustainability criteria for ductile iron pipe systems

Environmentally superior

- impermeability to diffusion
- linings
- scrap as the raw material
- ductile iron
- low expenditure on maintenance and repairs, and long operating life
- ▶ safeguards drinking water in all soil and installation conditions and the groundwater when sewage is being transported
- ▶ ensure that drinking water is transported hygienically and environmentally safely
- ▶ minimises the consumption of primary and fossil raw materials
- ▶ is recycled so saves resources for present and future generations
- ▶ minimises CO₂ emissions and the consumption of resources

Ductile iron pipe systems can be shown to produce true sustainability!

© eadips.org

Chart 2:

Economic sustainability criteria for ductile iron pipe systems

Economically superior

- push-in joints make for highly productive installation
- no welding needed
- installation in all weathers
- sand bedding often not required
- concrete thrust blocks not needed when joints are restrained
- joints can be deflected angularly
- wide range of fittings and valves available so no need for specials
- extremely low damage rates
- operating life of up to 100 years or more
- ▶ reduces labour costs
- ▶ reduces labour costs
- ▶ reduces labour costs
- ▶ reduces materials and logistics costs
- ▶ reduces materials and labour costs
- ▶ saves on fittings
- ▶ reduces materials and labour costs
- ▶ reduces repair and maintenance costs
- ▶ keeps renovation budgets to a minimum

Investing in ductile iron pipe system pays for itself in low installation and operating costs with, at the same time, a long operating life!

© eadips.org

Chart 3:

Technical sustainability criteria for ductile iron pipe systems

Technically superior

- the material is strong
- external protection
- static load-bearing capacity
- joints
- ductile iron
- installation
- restrained joints
- the material has superior properties
- ▶ allows operating pressures up to 100 bars
- ▶ shields against mechanical and chemical attack
- ▶ allows very high stresses in the transverse and longitudinal directions
- ▶ allow operating pressures up to 100 bars; are resistant to root penetration
- ▶ is non-combustible
- ▶ is possible with no special equipment
- ▶ allow very high tractive forces and are therefore ideal for trenchless installation
- ▶ which allow special applications in mountainous regions and for fire-fighting pipelines, snow-making systems and hydroelectric power stations

The technical performance of ductile iron pipe systems ensures the highest safety and reliability in all areas of the water industry!

© eadips.org

Albania needs pipelines for drinking water – the first soft loan project in Albania

by *Andreas Weiler and Claudia Mair*

1 Drinking water pipelines for the town of Bilisht

Bilisht, with its slightly more than 10,000 inhabitants, lies in the south-east of Albania almost on the border with Greece (**Fig. 1**). As is true almost everywhere in the country, the drinking water supply system in and around Bilisht is inadequate and it needs to be replaced and developed over the next few years. Only for a few hours a day can the population of the town get a supply of drinking water out of the pipe system. The pipeline network dates from the seventies and is decrepit and urgently needs to be renovated.

To guarantee a 24-hour supply of hygienically satisfactory drinking water for the growing population of Bilisht, the existing pipeline network needs not only to be replaced but also expanded. It was impossible for the town to finance this vast water supply project from its own resources. A solution to the problem of finding an assured source of the money for the mega-project was found in financing by a soft loan.



Fig. 1: The little town of Bilisht lies in the south-east of Albania on a plateau 930 m above sea level, close to the border with Greece

What is referred to as a soft loan is one on which the interest rate is below the usual market rate.

2 Soft loan financing

The Austrian Federal Ministry of Finance (BMF) offered a solution for financing the Bilisht supply project under the Austrian soft loan programme.

According to [1], the “aim of the programme is to assist developing countries in identifying and preparing for projects whose purpose is the sustainable economic and social development of these countries. For this purpose, the programme provides assistance for work to identify or prepare for projects in connection with projects principally in developing countries on the OECD’s DAC list which are of particular interest from the point of view of economic and development policy and which are defined as Austrian soft loan target countries (soft loan target countries in OECD categories 3–7), an example being Albania. “The programme is applied in those sectors in which projects are financed basically by Austrian soft loans.”

The other party to the contract for this turn-key project financed by an Austrian soft loan is the General Directory of Water Supply and Sewerage of the Albanian Ministry of Public Works and Transport.

3 Beginning of the installation operation and placing of the contract

There were certain hurdles which had to be overcome to get the first infrastructure project financed in this way in Albania on the road. After two years' work, perseverance and patience made it possible for the installation project to begin in January 2012. Once the planning consent had been given, the implementation of the operation to renovate and expand the water supply system of the town of Bilisht and the surrounding area went ahead at full speed. Preceding this, there had been the invitation to tender process for this turnkey project. This was won by the Duktus Tiroler Rohrsysteme GmbH company which became the general contractor.

4 Execution of the installation work

As well as the detailed planned (e.g. for nominal sizes and pressure ratings), the project also includes the supply and installation of the pipes and fittings, etc. for the new drinking water network, the setting up of a laboratory and administration building, the treatment of the water and the building of the pumping stations and reservoirs.

What are being supplied for the drinking water supply network are 50 kilometres of ductile iron pipes to EN 545 [2] of nominal sizes of DN 80 (13,788 m), DN 100 (9,720 m), DN 150 (12,966 m) and DN 200 (12,906 m) and of PN 10 pressure rating with restrained BLS®/VRS®-T push-in joints and a PUR Longlife finishing layer. The PUR Longlife finishing layer is a polyurethane finishing layer to Austrian standard ÖNORM B2560 [3]. All the ductile iron pipes and ductile iron fittings are being supplied by the general contractor (**Fig. 2**). Expert instruction was given to the site personnel by the pipe supplier to ensure that the manual work done when the pipelines were being installed was carried out correctly (**Fig. 3 and 4**).

5 Controlling the project

It was agreed that all the deadlines had to be arranged and co-ordinated with the installing company STRABAG AG of Vienna (Austria) and with its sub-contractor TREMA Engineering 2 sh.p.k of Tirana (Albania), which is installing the new water pipelines in Bilisht. All the ductile iron pipes and fittings have been delivered on time by the Austrian pipe manufacturer.



Fig. 2: 50 km of ductile iron pipes have been delivered to Albania for the Bilisht infrastructure project



Fig. 3: The installation crews were given on-site instruction in Bilisht on all the subjects relevant to installation



Fig. 4: Training in pulling a ductile iron bend onto the spigot end of a ductile iron pipe

The firm given responsibility for management accounting for the project was HÖCHTL & PARTNER GmbH of Vienna (Austria), which had a member of staff constantly on site for this purpose. The client appointed the ÖSTAP Engineering & Consulting GmbH company of Vienna (Austria) for the monitoring and acceptance testing of the work.

6 To sum up

The deliveries and installation work are continuing into 2013 (**Fig. 5**) – the aim is for the project then to be completed by satisfactory final acceptance.

The infrastructure project on the drinking water supply system of the town of Bilisht is a good example to show that the starting point for regional development is a secure supply of that vital necessity, water. This is the only way of achieving an upturn in the local economy – and ductile iron pipes system do their sustainable bit to help.



Fig. 5:

A large number of the ductile iron pipes with a PUR Longlife coating have already been installed; the project will be completed in 2013.

References

- [1] http://www.bmf.gv.at/WipoEUInt/Export-Förderung/SoftLoanProjketVorb_7264/Projectvorbereitungsprogramm_SL_-_final_vers_01-01-09.pdf
- [2] EN 545
Ductile iron pipes, fittings, accessories and their joints for water pipelines – Requirements and test methods
2010

- [3] ÖNORM B 2560
Ductile iron pipes –
Finishing paints of polyurethane or epoxy materials –
Requirements and tests
2004

Authors

Andreas Weiler
Duktus Tiroler Rohrsysteme GmbH
Innsbrucker Straße 51
6060 Hall in Tirol, Austria
Phone: +43 (0)52 23/5 03-1 05
E-mail: andreas.weiler@duktus.com

Claudia Mair
Duktus Tiroler Rohrsysteme GmbH
Innsbrucker Straße 51
6060 Hall in Tirol, Austria
Phone: +43 (0)52 23/5 03-1 01
E-mail: andreas.mair@duktus.com

Installing company

STRABAG AG
Donau-City-Straße 9
1220 Vienna, Austria

TREMA Engineering 2 sh.p.k
Ilir Trebicka
Rruga Bardhok Biba, Old Tirana Building
Tirana, Albania
Phone: +355 4 2266618
E-mail: trebickailir@tremaengineering2.com.al

Management accounting

HÖCHTL & PARTNER GmbH
Dipl.-Ing. Martin F. Höchtl
Münzgasse 3/1
1030 Vienna, Austria
Phone: +43 1 920 8106
E-mail: office@hoechtlpartner.eu

Monitoring and acceptance testing

ÖSTAP Engineering and Consulting GmbH
Dipl.-Ing. Johannes Benda
Heiligenstädter Straße 51/3
1190 Vienna, Austria
Phone: +43 1 505 2743
E-mail: office@oestap.at

Pipe runs rehabilitated for the Aggerverband supply utility by replacing valves and fittings

by Dieter Wonka, Klaus Eisenhuth and Martin Herker

1 Introduction and past history

Under the rules of the then regulations governing water supply utilities formed by associations, the Aggerverband supply utility was formed in 1943 as an association (Verband) of districts, municipalities and industrial estates in the catchment area of the river Agger.

In 1992, the government of the federal state of North Rhine-Westphalia passed the Law relating to the Aggerverband and all the main tasks relating to water management in the 1,100 km² area between the Wupper and Sieg rivers served by the Aggerverband were passed to the Aggerverband.

The Aggerverband is divided into departments dealing with dams and watercourses, sewage and wastewater, and drinking water. At the moment the drinking water department has:

- 2 waterworks for some 450,000 inhabitants
- 33 service reservoir sites with 45 reservoirs
- 221 km of trunk mains with
- 86 transfer points to 20 municipalities or further distributors
- 11 pumping stations for pure water and
- 1 pumping station for raw water.

2 General points relating to drinking water supply by the Aggerverband and to its trunk main network

Every year, the Aggerverband treats some 22 million m³ of surface water from the Genkel and Wiehl drinking water dams at two waterworks. Most of the water passed on to the municipalities as end suppliers is passed on from the

Aggerverband's own service reservoirs, which in turn are supplied by the Aggerverband's own trunk main network.

The pipelines which are being operated are of nominal sizes from DN 150 to DN 1200. In the DN 150 to DN 600 range, the supply network consists of, amongst other things, some 56 km of ductile iron pipes and around 34.5 km of grey cast iron pipes.

3 Rehabilitating runs of pipe by replacing valves and fittings

The rehabilitation work can be summed up as follows:

- The rehabilitation, which was scheduled, began back in 1992 with the in-situ lining of runs of pipe with cement mortar.
- Valves and fittings have been replaced at all the high points and low points and in all the manholes holding distributors or transfer points.
- To optimise the pipeline network, some of the manholes holding distributors have been combined with ones holding transfer points, thus enabling the number of manholes to be reduced from five to three.
- For pipe run rehabilitation operation RS33, fittings of special dimensions were produced to the Aggerverband's specifications to simplify installation and reduce the number of flanged joints.
- Ductile iron flanged pipes to EN 545 [1] matched to their respective installation situations were produced as specials with shrunk-on welded flanges [2, 3] by the Ludwig Frischhut GmbH & Co. KG company of Pfarrkirchen.

- The puddle flanges, flanged connecting pipes and threaded hubs were fitted in the required positions called for by the installation situation [4, 5]. Also, at sizes up to and including DN 300, screw-on puddle flanges were fitted by the installer (**Figs. 1, 2 and 3**).
- The coating selected was an epoxy powder coating (thickness of layer > 250 µm) complying with the requirements of the German Quality Association for the Heavy Duty Corrosion Protection of Powder Coated Valves and Fittings (GSK) [6].
- Before being coated, the welded special fittings were tested for leaks in the manufacturer's works to EN 545 [1].



Fig. 1: Distributor 1 – internal measurement to monitor for pipe fractures: DN 150 welded-flange pipe with 2" connecting thread

Following a successful pressure test, the high quality of the components used allowed the pipeline to go straight into operation, on schedule.



Fig. 2: Distributor 3 – new transfer point: passage through the wall by a DN 250 welded-flange pipe with a puddle flange and by a DN 80 flanged connecting pipe



Fig. 3: Distributor 3 – internal measurement to monitor for pipe fractures: DN 100 welded-flange pipe with 2" connecting thread

References

- [1] EN 545
Ductile iron pipes, fittings, accessories
and their joints for water pipelines –
Requirements and test methods
2010
- [2] DVS (German Welding Society) 0602
Schweißen von Gusseisenwerkstoffen
2008-02
- [3] DVS (German Welding Society) 1502-1
Lichtbogenhandschweißen an Rohren
aus duktilem Gusseisen –
Schweißtechnische Grundsätze
1995-11
- [4] DVS (German Welding Society) 1502-2
Lichtbogenhandschweißen an Rohren
aus duktilem Gusseisen –
Anschweißen von Teilen aus duktilem
Gusseisen oder aus Stahl
1995-11
- [5] EADIPS®/FGR® Standard 37
Formstücke aus duktilem Gusseisen –
Angeschweißte Anschlüsse –
Maße
2012-02
- [6] RAL GZ 662
Schwerer Korrosionsschutz von
Armaturen und Formstücken durch
Pulverbeschichtung –
Gütesicherung
2008-01

Authors

- Dieter Wonka
Der Aggerverband
Abteilung Trinkwasser
Sonnenstraße 40
51645 Gummersbach, Germany
Phone: +49 (0)22 61/3 63 50
E-mail: Dieter.Wonka@aggerverband.de
- Klaus Eisenhuth
Der Aggerverband
Abteilung Trinkwasser
Sonnenstraße 40
51645 Gummersbach, Germany
Phone: +49 (0)22 61/3 63 59
E-mail: Klaus.Eisenhuth@aggerverband.de
- Martin Herker
Ludwig Frischhut GmbH & Co. KG
Konstruktion
Franz-Stelzenberger-Straße 9–17
84347 Pfarrkirchen, Germany
Phone: +49 (0)85 61/30 08-2 61
E-mail: mherker@talys-group.com

Zurich's Durchmesserlinie cross-city rail link – an XL size mega project

by Steffen Ertelt

1 Introduction

The Durchmesserlinie cross-city rail link is Switzerland's biggest city-centre construction site. It connects the Altstetten, Zurich Main and Oerlikon stations and provides Zurich Main Station with the relief it needs from its traffic load and allows more fixed timetables to be achieved throughout Switzerland. At the heart of the Durchmesserlinie is a second underground transit station, Zurich Löwenstrasse. In the westerly direction, the tracks of the Durchmesserlinie run from Langstrasse to Zurich Altstetten over two new bridge structures. Towards the east, trains leave the transit station on two tracks through the Weinberg tunnel. After around 5 km, the tunnel opens into the Oerlikon cutting. At Oerlikon, Swiss Federal Railways (SBB) is widening the cutting and Oerlikon station to accommodate the two tracks [1].

For fire protection, a 4.8 km long ductile iron pipeline for fire-fighting water has been installed in the Weinberg tunnel.

2 Sinking of a shaft on the Brunnenhofareal

The boring of the Weinberg tunnel was a major challenge. The tunnel boring machine was able to start work in October 2008, thirteen months after the construction work for the project began. One prerequisite for this was, however, the sinking of a shaft some 40 m deep and some 23 m in diameter in the area known as the Brunnenhofareal. Later on, this shaft was also used to bring in the ductile iron pipes. **Figs. 1 and 2** give an impression of the size of the shaft.

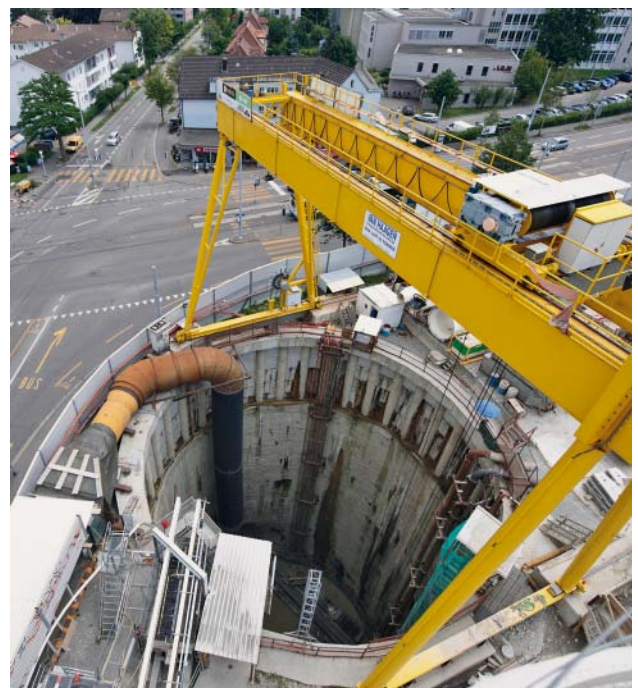

Fig. 1:
Looking down into the Brunnenhof shaft



Fig. 2:
Looking up from the
Brunnenhof shaft

3 Use of ductile iron pipe systems for fire protection

Ductile iron pipes have been successfully used for pipelines for fire-fighting water for decades now. Important criteria influencing the decisions made by clients when selecting the pipes used are generally the high safety margins offered by ductile iron as a pipe material and the load-bearing capacity of the restrained joints under high internal pressures and possible pressure surges.

A total of 4,800 m of DN 200 ductile iron pipes to EN 545 [2] with restrained BLS®/VRS®-T push-in joints (Fig. 3) were used for the "Zurich Durchmesserlinie" project. Pipes of this nominal size and the standard wall thickness (wall-thickness class K 9) are designed for an allowable operating pressure (PFA) of 42 bars.

The BLS®/VRS®-T push-in joint is a positive locking push-in joint with a welded bead applied in the factory (Fig. 4).

Once the spigot end has been pushed in, the locks or locking segments are inserted into a restraining chamber cast into the socket of the pipe and are secured by a catch (Fig. 6). They are inserted through special openings in the end-face of the socket (Fig. 5). If axial tractive forces are applied to the joint, either due to internal pressure or because the pipes are being used in a trenchless pulling-in technique, the welded bead is supported against these secured locks or locking segments and these latter in turn are supported against the wall of the restraining chamber. The joint is now secured against longitudinal forces in the long term but remains flexible. A cement mortar coating to EN 15542 [3] is used to protect the pipes externally.

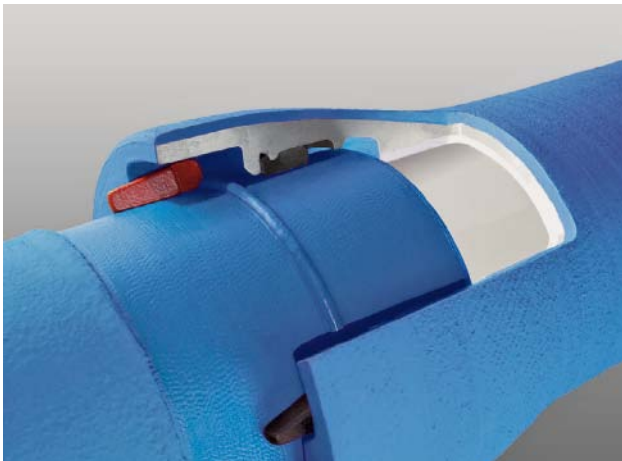

Fig. 3:
The BLS®/VRS®-T push-in joint



Fig. 5:
Insertion openings of the restrained BLS®/VRS®-T push-in joint



Fig. 4:
The welded bead applied in the factory

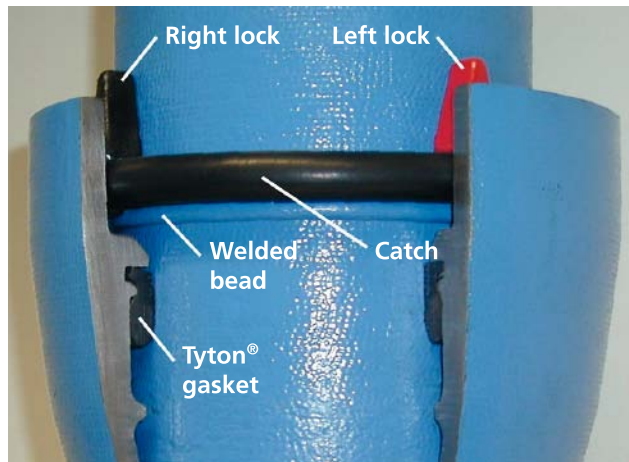

Fig. 6:
Inserted locks and catch

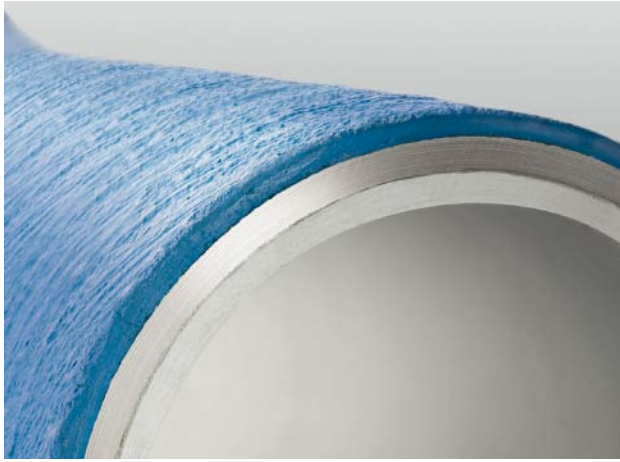

Fig. 7:
Cement mortar coating (ZM-U) to EN 15542 [3]

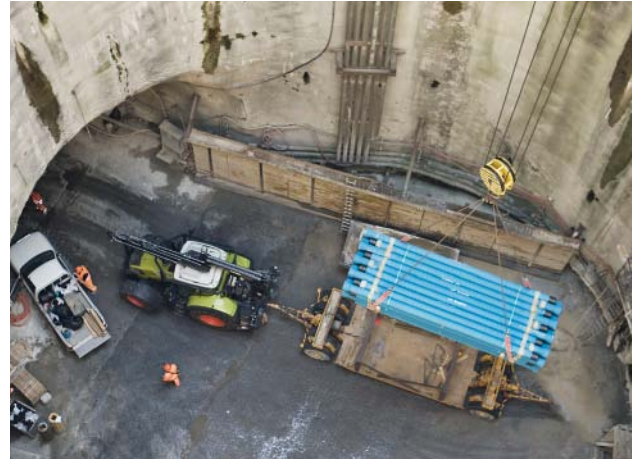

Fig. 9:
Bundles of pipes being laid down on the pipe transporting carriage

The layer of cement mortar is applied to the zinc coating on the outside of the pipe (**Fig. 7**). This finishing layer is extremely rugged mechanically and the advantage it has is that the zinc coating situated underneath it continues to have its active protective effect.

4 The installation work

The bundles of DN 200 pipes were lifted into the shaft by crane (**Fig. 8**) and laid down on the pipe transporting carriage on the floor of the tunnel (**Fig. 9**). This transporting unit enabled the pipes to be transported in the tunnel and extended without any problems (**Fig. 10**). The crane mounted on the towing tractor was used to lift the pipes into the utility channel holding the pipeline (**Fig. 10**) and to lay them down on the existing pipe supports (**Fig. 11**).



Fig. 10:
Towing tractor and crane boom



Fig. 8:
Lifting the bundles of DN 200 pipes in via the existing launch shaft



Fig. 11:
Pipe supports in the utility channel



Fig. 12:
Hydrant for supplying fire-fighting water

The transport sling hanging from the crane boom was then used to pull the spigot end of a pipe into the BLS®/VRS®-T socket. This unconventional procedure enabled the company installing the pipeline, JMAG of Sarmenstorf, to achieve a laying rate per day of 250 m to 300 m. A hydrant which will subsequently supply fire-fighting water in the event of a fire is positioned every 250 m (**Fig. 12**). Two connections for fire-fighting water are also provided at each emergency escape exit.

The water supply capacity of the system for fire-fighting water is designed to be 2,400 L/min, which will allow 1,200 L/min to be drawn from two take-off points simultaneously. The fire-fighting water is fed into the pipeline by Zurich's water supplier Wasserversorgung Zürich (WVZ) and, in the region of the main station, from Swiss Federal Railways' water network.

5 To sum up

Ductile iron pipes with the BLS®/VRS®-T joint system have already been used on many fire protection projects (e.g. in road tunnels, rail tunnels and industrial plants).

This restrained push-in joint can be used generally for the laying of fire-fighting pipelines. It is positive locking and because of this the possible safety it offers is incomparably high. At the DN 80 and DN 100 nominal sizes, operating pressures of up to 100 bars are allowable – even at the maximum possible angular deflection of 5°. At the same time, an angular deflection of this kind allows curves with a possible radius of only some 70 m to be



Fig. 13:
Installed section of pipeline radiused through a curve – rapid transit trains will pass this point at 120 km/h

followed with pipes of a laying length of 6 m. This enables the ductile iron pipeline to be matched harmoniously to the path followed by the road, bridge or tunnel, and this means a saving can be made on fittings (**Fig. 13**). The installation of the fire-fighting pipeline in the Weinberg tunnel has now been completed. It is an important part of the project as a whole. It carries with it the hope that this system will never have to be used to fight a fire in earnest!

References

- [1] SBB website – Ausbau Schienennetz-Durchmesserlinie Zürich of 01.10.2012
- [2] EN 545 Ductile iron pipes, fittings, accessories and their joints for water pipelines – Requirements and test methods 2010
- [3] EN 15542 Ductile iron pipes, fittings and accessories – External cement mortar coating for pipes – Requirements and test methods 2008

Author

Dipl.-Ing. Steffen Ertelt
Duktus Rohrsysteme Wetzlar GmbH
Sophienstraße 52-54
35576 Wetzlar, Germany
Phone: +49 (0)64 41 / 49-12 67
E-mail: steffen.ertelt@duktus.com

Water mains in Lucerne's Sonnenberg and Reussport autobahn tunnels

by Roger Saner

1 Introduction

Lucerne, with its 60,000 inhabitants, is the gateway to central Switzerland and is situated in the centre of the Lake Lucerne region. More than 1.8 million tourists from all over the world visit the city every year. Its world famous landmark is the historic Kapellbrücke or Chapel Bridge dating from the 14th century, which was built entirely of wood.

EWL, Energie Wasser Luzern is the supply company which supplies the city and the Lucerne region – five neighbouring municipalities and, when demand is high, three other water suppliers in the surrounding area – with drinking water, electricity, natural gas and heat. Through a pipeline network 180 km long, EWL distributes more than 10 million m³ of drinking water every year.

From the point of view of traffic too, Lucerne is situated in the heart of Switzerland, namely right on the principal north-south traffic artery in Europe, the A 2 autobahn. This route is the direct one for transit traffic from Germany through Switzerland to Italy. The A 2 autobahn comes from Basel and runs through the centre of Lucerne to Chiasso and, in the north of Lucerne, it also takes all the delivery and transit traffic from the Zurich and Zug regions coming from the A 14 autobahn. All told, the volume of traffic on the A 2 autobahn is an average of 60,000 to 90,000 vehicles a day.

Because of the very dense concentration of buildings above ground, the two Reussport and Sonnenberg urban tunnels, which were built between 1972 and 1976, take all the traffic on the A 2 autobahn through the city of Lucerne below ground (**Fig. 1**).

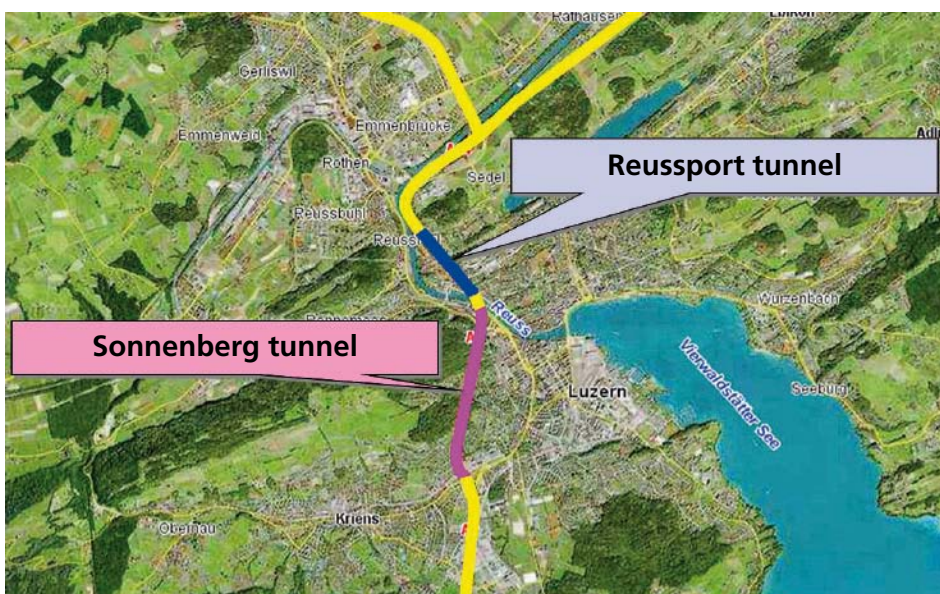

Fig. 1:
The traffic situation in the city of Lucerne

Because of the poor overall state of the carriageways and above all because of the two urban tunnels, the A 2 autobahn through Lucerne has, since 2007, been undergoing a general rehabilitation between Reussegg in the north and Grosshof in the south (the “City Ring”). This is due for completion in 2013.

2 The Sonnenberg tunnel acting as the world’s biggest nuclear bunker

If there had been a war, this nuclear bunker built between 1971 and 1976 would have provided protection for 20,000 people – it was the world’s biggest nuclear bunker.

At the heart of the bunker were the two autobahn tunnels and these would have been converted to become shelters. Four armoured doors would have sealed off the entrances to the tunnels hermetically. Each door weights 350 t and would have withstood the pressure from an exploding atom bomb. The logistics and utilities centre and an emergency hospital were housed in a seven-storey underground building above the tunnel tubes.

Between 2006 and 2008 the Sonnenberg nuclear bunker was reduced in size. The autobahn tunnels will not now be converted into the bunker if there is a war. However, as the general “City Ring Lucerne” rehabilitation progressed, it was ensured that two of the four armoured doors could still be seen (Fig. 2) and that there was still access to the two passages leading round them, with markings to indicate both on the tunnel walls. A notice on the wall “20,000 under the ground” reminds drivers of the earlier function of the two tunnel tubes [1].



Fig. 2: An armoured door in the Sonnenberg tunnel

3 The initial situation of the existing spaces for utilities in the urban tunnels

The existing spaces for utilities arranged in the cross-sections of the tunnels were at full capacity and no longer met present-day requirements. Due to deposits or corrosion it was no longer possible for the pipelines and cables to be replaced in many cases. The cables lying on the false ceiling below the fresh air duct were very much at risk of being burnt in the event of a fire in the tunnels. The tunnels thus no longer met safety requirements. Situated below the carriageways there were also DN 300 and DN 400 water mains belonging to EWL’s civic supply network and maintenance and repair work on these regularly resulted in tunnel closures and tremendous traffic problems (Fig. 3).

A variety of possible solutions were looked at for re-installing the utilities:

- re-laying within the tunnel tubes,
- solutions employing microtunneling,
- utility galleries below, between and above the tunnel tubes.

Due to the large number of utility pipes and cables and the combination with the water supply mains, what was finally selected was the solution using utility galleries accessible on foot. This had the following advantages:

- all the pipelines could be run separately outside the tunnel cross-section (no conflicts between traffic and maintenance),
- there is optimum access to all the pipelines,
- safety in the event of a fire is increased by hydrants in all the cross-passages.

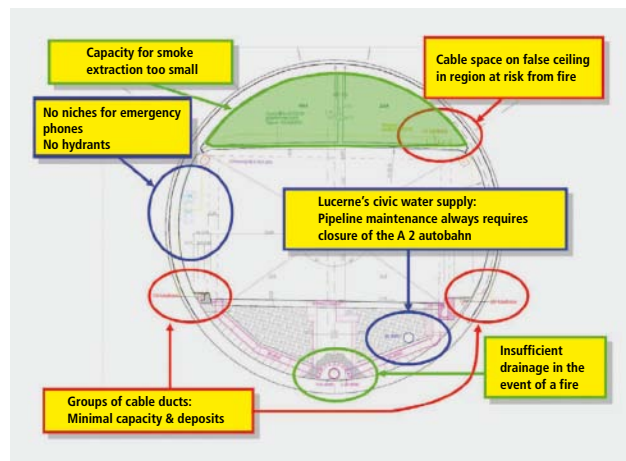

Fig. 3: Initial actual state in the tunnel tubes

It was essential for the work needed for the new utility galleries, including the re-laying of all the utilities from the tunnel tubes, to be completed before the general rehabilitation of the “City Ring Lucerne” autobahn began. This was also true of the work on the water mains belonging to the civic water supply network and of the direct upgrading of the reservoir on the hill known as the Gütsch, a well-known destination for trips out in Lucerne.

4 The new Sonnenberg and Reussport utility galleries

Two new utility galleries 4 m in diameter were therefore driven by a tunnel boring machine along the routes of the two Sonnenberg and Reussport tunnels (Figs. 4 and 5).

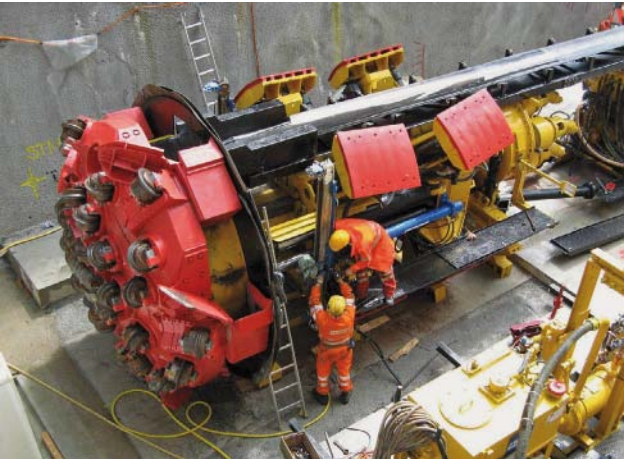

Fig. 4:
The tunnel boring machine – getting it ready



Fig. 5:
The tunnel boring machine – in operation

The utility galleries are connected to the tunnel system by vertical shafts. The positions of the new utility galleries resulted from the existing situation and the complicated geology of the ground.

In the Sonnenberg section the utility gallery runs above the tunnel tubes. The utility gallery was widened locally in the regions above the cross-passages between the two tunnel tubes and it was connected to the cross-passages by vertical shafts (Fig. 6).

In the Reussport section the utility gallery runs below the tunnel tubes.

This utility gallery was likewise widened, but below the cross-passages between the two tunnel tubes, and was likewise connected to the cross-passages by vertical shafts (Fig. 7).

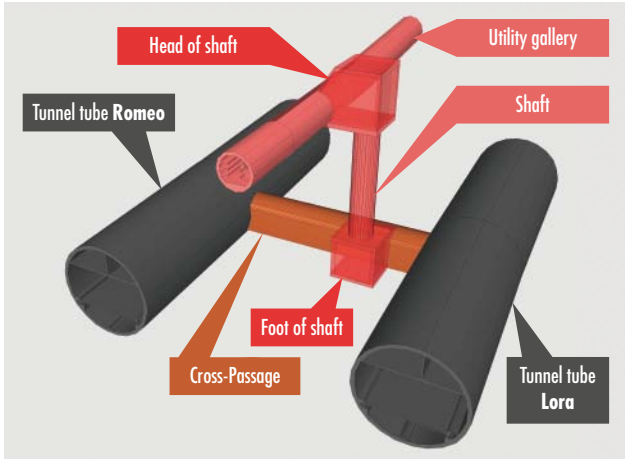

Fig. 6:
Cross-section showing the Sonnenberg utility gallery



Fig. 7:
Connecting pipeline between utility gallery and cross-passage in the Reussport tunnel

5 The water main and hydrant pipeline project

This project consisted firstly of the installation of the water main pipelines in the new utility galleries and secondly of the upgrading of the tunnel systems with hydrant pipelines which run through the vertical shafts.

The new water main pipelines are therefore a combination of water supply pipelines and hydrant supply pipelines. Because of the special conditions in the utility tunnels and because of the lack of space in the vertical shafts and the cross-passages, the pipes selected were vonRollecopur ductile iron pipes, which EWL has been successfully using for many years in its pipeline network. They have shown up well when being assembled, when in operation and in respect of their very long operating life.

Under EN 545 [2], vonRollecopur fully protected ductile iron pipes with an integral pore-free internal and external coating of polyurethane are classified as pipes with a reinforced coating and are suitable to use in all conditions of installation. Their flexible push-in joints mean that they are highly suitable for use as suspended non-buried pipelines in tunnels and galleries in which the atmosphere is damp and warm. vonRollecopur fully protected pipes can be restrained against longitudinal forces with the well-tried vonRollhydrotight thrust resistance system. To round off the system there are vonRollecofit fittings with an integral epoxy coating to EN 14901 [3] and RAL GZ 662 [4].

The following advantages meant that the pipes were considerably easier to assemble in the utility gallery:

- low weight compared with other pipe systems,
- easy handling and assembly (**Fig. 8**),
- very small amount of space required for working on the pipes
- the polyurethane coating does not have to be shaved off
- flexibility in cutting the pipes (no welded beads required).

Ductile iron pipes to the following specifications were used in the utility galleries and cross-passages (the quantities shown are the main ones):

Sonnenberg tunnel section

Water main pipeline:

1,500 m of vonRollecopur pipes DN 500, K 9

Hydrant pipeline:

150 m of vonRollecopur pipes DN 125, K 9

Reussport tunnel section

Water main pipeline:

660 m of vonRollecopur pipes DN 300, K 9

Hydrant pipeline:

100 m of vonRollecopur pipes DN 125, K 9



Fig. 8:
Assembling a pipe in the utility gallery



Fig. 9:
An assembled run



Fig. 10:
An assembled run at radiuses up to $R = 200$ m



Fig. 11:
Fig. 2806, the vonRollhydrotight push-in joint with external thrust resistance system



Fig. 12:
Fig. 2807 A, the vonRollhydrotight push-in joint with internal thrust resistance system

5.1 The water main pipelines

Under the planned design, all the forces on the pressure pipelines occurring in the utility galleries were to be transmitted directly into the non-reinforced twin-shell gallery arch.

For this purpose, the vonRolle*copur* ductile iron pipes rest on galvanized steel supports in the form of cantilever arms (**Fig. 9**). The steel supports are each anchored directly into the inner shell of in-situ concrete. Along the non-fixed run, which follows curves radiused at up to 200 m, the steel supports take the form of what are known as “slide supports”, to carry the ductile iron pipes which are capable of angular deflections of up to 5° (**Fig. 10**). The supports are sized to take the dead weight of the pipeline and the forces resulting from the system test pressure STP = 13 bars which are applied at the angular deflections. Thrust resistance systems were deliberately not used in these regions to enable the pipeline to move if there are temperature fluctuations for example. In the widened areas between the vertical shafts and the cross-passages connecting the tunnel tubes, the arch consists of a shell of sprayed concrete which follows an uneven path. At these points, the pipes are therefore supported on heavy steel stands which are set up on the floor of in-situ concrete and which are anchored to act as fixed points. Following on from the widened areas, the steel supports at the transitions to the straight runs, which are anchored into the inner shell of in-situ concrete, are likewise designed to act as fixed points and are dimensioned for the maximum system test pressure STP of 13 bars.

For safety, all the joints of the pipes and fittings in the widened areas and two pipes before and after the widened areas are restrained by

vonRoll*hydrotight* thrust resistance systems Fig. 2806 (**Fig. 11**) or Fig. 2807 A (**Fig. 12**) to allow the forces to be transmitted directly into the concrete (**Fig. 13**). This ensures that, if there is a pressure surge, the ductile iron pipes immediately after the point at which the resulting force changes direction cannot swing on the “slide supports” and splay apart.

5.2 The hydrant pipelines

So that the water in the water mains does not suffer any microbial contamination, security from the hydrant pipelines is provided by valves for drinking water protection and remotely controlled solenoid gate valves.

From the water mains in the widened areas, the hydrant pipelines run straight to the cross-passages between the two tunnel tubes through the new vertical connecting shafts up to 12 m deep which have now been driven. Here too the DN 125 vonRolle*copur* fully protected pipes are fixed into the concrete on galvanized steel supports acting as fixed points for the direct transmission of forces. The pipes also have restrained socket joints restrained by the vonRoll*hydro-tight* thrust resistance system.

For the take-off of fire-fighting water, temporary Storz fire hose connections are fitted to the hydrant pipelines in each of the cross-passages in the region of the shaft feet (**Fig. 14**).

As part of the general rehabilitation of the Reusport and Sonnenberg tunnel systems, these hydrant pipelines will later be lengthened into the traffic spaces in the tunnel tubes (**Fig. 15**).



Fig. 13:
Widened area containing steel stands – completed state

6 Connecting the DN 500 water main pipeline within the Sonnenberg North central control and equipment building

A particular challenge for everyone involved and particularly for the pipeline installers was connecting the new DN 500 water main pipeline to the North central control and equipment building for the Sonnenberg tunnel.

From the existing position of the pipeline on a level with the carriageways in the two tunnel tubes, the new DN 500 pipeline had to be run vertically into the existing Northern central control and equipment building and had to



Fig. 14:
Hydrant pipeline with temporary Storz fire hose connection

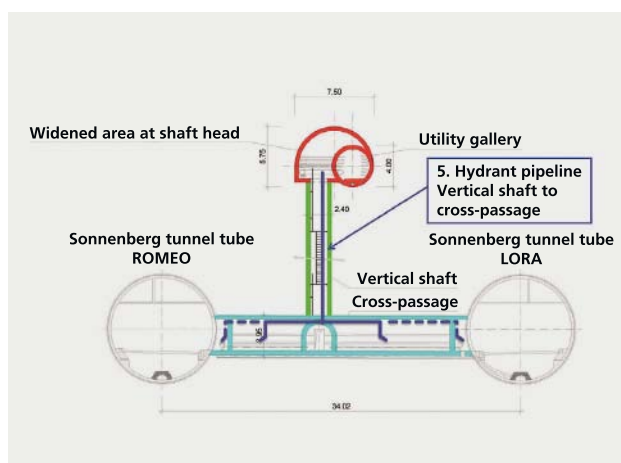

Fig. 15:
Cross-section showing utility gallery and hydrant pipeline to the Sonnenberg tunnel tubes

beinstalled over a distance of 50 m between closely spaced compartment walls to the point where it entered the utility gallery (**Fig. 16**).

Because of the cramped conditions and the oblique gradient of part of the pipeline, what were used were specially produced fully protected pipes with flanged joints together with vonRollecofit flanged fittings. The flanged pipes were produced to an accuracy of millimetres from measurements made on site and were an exact fit when installed between the compartment walls. As in the utility gallery, they were fixed to the concrete walls or the concrete ceiling as fixed points using structures of galvanized steel (**Fig. 17**).

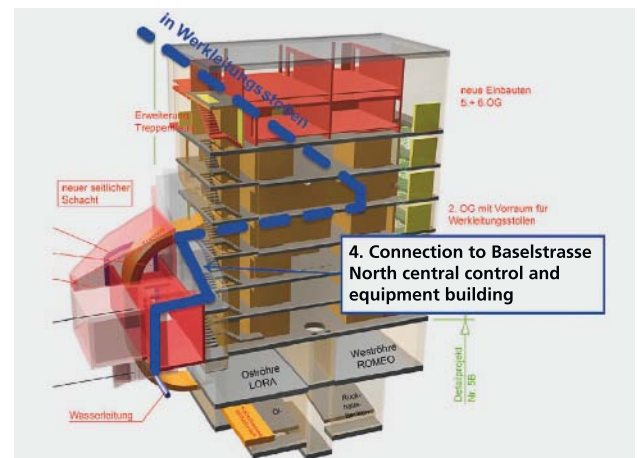

Fig. 16:
Cross-section at the North central control and equipment building



Fig. 17:
Pipeline run through between closely spaced compartment walls

7 To sum up

The driving of the two new utility galleries and the re-laying of all the utility pipelines from the Sonnenberg and Reussport tunnel tubes were the prerequisite for the general rehabilitation of the “City Ring Lucerne” autobahn.

Thanks to the use of sustainably superior DN 300 and DN 500 vonRollecopur fully protected ductile iron pipes of wall thickness class K 9, the water main pipelines belonging to the civic water supply network could be laid efficiently and with great flexibility.

What made particularly exacting demands on the ease of assembly of the pipes selected was the running of the pipelines in the rather unusual installation situation in the utility galleries and under the very cramped conditions in the vertical shafts and between the compartment walls in the Sonnenberg North central control and equipment building.

The vonRollecopur fully protected push-in pipe system with a reinforced coating to EN 545 [2] has an integral internal and external coating of polyurethane and is a guarantee of a very high standard of corrosion protection. It is resistant to the damp and corrosive atmosphere in tunnels and also to any kind of galvanic corrosion caused by stray currents and the formation of macro-cells.

References

- [1] Bundesamt für Verkehr (ASTRA)
“20,000 im Berg”:
Nuclear bunker in Fig. 2 of Sonnenberg tunnel
http://www.cityring.ch/2011_09_07_zivil-schutzanlage.pdf
- [2] EN 545
Ductile iron pipes, fittings, accessories and their joints for water pipelines –
Requirements and test methods
2010
- [3] EN 14901
Ductile iron pipes, fittings and accessories.
Epoxy coating (heavy duty) of ductile iron fittings and accessories. Requirements and test methods
2006
- 4] Güte- und Prüfbestimmungen
RAL GZ 662
Schwerer Korrosionsschutz von
Armaturen und Formstücken durch
Pulverbeschichtung
2008-01

Author

Dipl.-Ing. Roger Saner
vonRoll hydro (suisse) ag
Von Roll-Strasse 24
4702 Oensingen, Switzerland
Phone: +41 (0)62/3 88 12 37
E-mail: roger.saner@vonroll-hydro.ch

Client for water main and hydrant pipelines

ewl energie wasser luzern
Eidg. Dipl. Haustechnikinstallateur
Guido Huber
Industriestrasse 6
6006 Lucerne, Switzerland
Phone: +41 (0)41/3 69 42 54
E-mail: info@ewl-luzern.ch

Lead project management

Kanton Luzern
Verkehr und Infrastruktur vif
Dipl.-Ing. (FH) Andreas Heller
Arsenalstrasse 43
6010 Kriens/Switzerland
Phone: +41 (0)41/3 18 12 12
E-mail: vif@lu.ch

Consulting engineers/planners

ewp bucher dillier AG Luzern
M. Sc. ETH Matthias Bucher
Industriestrasse 6
6005 Luzern/Switzerland
Phone: +41 (0)41/3 68 07 77
E-mail: matthias.bucher@ewp.ch

Pipeline installation

Baumeler Leitungsbau AG
Hans Baumeler
Löwenstrasse 6
6004 Luzern/Switzerland
Phone: +41 (0)41/4 10 33 47
E-mail: h.baumeler@baumelerltg.ch

Pillar hydrants for the fire-fighting system in the Jagdberg tunnel

by Petra Klingebiel

1 Geographic position of the Jagdberg tunnel

The Jagdberg tunnel is currently under construction and is a 3.1 km long tunnel on the A 4 federal autobahn to the west of Jena (**Fig. 1**). It crosses below the Ilm-Saale plateau, a shell limestone formation below the valleys of the Ilm (near Weimar) and Saale (near Jena) rivers. The tunnel is named after the 288 m high Jagdberg mountain which is situated between Jena-Göschwitz and the eastern portal.

2 Improving the traffic situation

The construction of the tunnel will remove a bottleneck on the existing A 4 autobahn. The volume of traffic which currently exists is more than 50,000 vehicles a day and the "Reich autobahn" built in the 1930's is no longer up to present day requirements.

The reasons behind the decision to build the tunnel were, parts of the autobahn where the gradient was very high and lorries had to reduce speed enormously, thus greatly impeding the flow of traffic, poor visibility on the bends because of carriageways at different heights and supporting walls along the central reservation, and serious noise pollution and pollution from emissions for nearby centres of population and the nature reserve and bird protection area. The subsequent demolition of the old road will make an active contribution to protecting the environment.



Fig. 1:
Eastern portal of the Jagdberg tunnel

3 Construction of the Jagdberg tunnel and the system for fire-fighting water

Construction of the 3.1 km long tunnel began on 25.09.2008. In the months that followed, two tunnel tubes were driven through the Jagdberg by the top-heading and bench method for the building between Eisenach and Görlitz of a new six-lane section of the A 4 autobahn.

An important factor in the demanding safety requirements is the need to ensure fire protection in a structure of this kind. In April 2012, Keulahütte GmbH supplied the first of a total of 48 hydrants for withdrawing water from the system for fire-fighting water which has been installed.

4 DN 80 pillar hydrants

Keulahütte GmbH's pillar hydrants are approved by the DVGW (German Technical and Scientific Association for Gas and Water). What

have been installed are DN 80 nominal size double shut-off pillar hydrants (**Fig. 2**). The cover above the supply pipe is 1.25 m (**Fig. 3**). A special feature is the facility for draining the hydrant once it has been closed. An angle connection pre-fitted in the factory allows the water left in the hydrant to be drained off into the pipe system provided for this purpose in the tunnel (**Fig. 4**).

By the time of the opening in 2014, Keulahütte GmbH will have supplied further pillar hydrants to EN 14384 [1] and EN 1074-6 [2] and a variety of fittings to EN 545 [3].

5 Other applications of pillar hydrants in tunnels

This variant pillar hydrant with drainage facilities which is used in the Jagdberg tunnel has already been a success in other Thuringian road tunnels such as

- the 1.1 km long “Porzberg” tunnel near Schaala (**Fig. 5**),
- the 1.7 km long “Schmücke” tunnel near Sömmerda and
- the tunnel on the A 4 on the edge of Jena and
- the external part of the “Heidkopf” tunnel on the A 38 autobahn

References

- [1] EN 14384
Pillar fire hydrants
2005
- [2] EN 1074-6
Valves for water supply. Fitness for purpose requirements and appropriate verification tests. Hydrants
2008
- [3] EN 545
Ductile iron pipes, fittings, accessories and their joints for water pipelines – Requirements and test methods
2010

Author

Ing. oec. Petra Klingebiel
Keulahütte GmbH
Geschwister-Scholl-Straße 15
02957 Krauschwitz, Germany
Phone: +49 (0) 3 57 71/54-2 60
E-mail: klingebiel@vem-group.com



Fig. 2:
DN 80 pillar hydrant
with two outlets



Fig. 3:
Pillar hydrant for cover of
1.25 m above supply pipe



Fig. 4:
Drainage facility for the closed hydrant through an
angle connection for drainage



Fig. 5:
The Porzberg tunnel near Schaala

Replacement of the pressure pipeline to Giessbach power station on Lake Brienz

by Wolfgang Rink

1 Introduction

The Giessbach hydroelectric power station was built in 1948/1949 and was put into operation by Hotel Giessbach AG. Since then, it has generated electricity for EW Reichenbach Energie AG and, since 1 September 1999, for the Brienz municipal utility Gemeindebetriebe Brienz (GBB).

In 2001, the municipality of Brienz was granted a water power licence for another 40 years for this power station.

GBB's original plan was to replace the 78 year old machinery set (a horizontal Pelton turbine plus generator) in 2006. Its pressure pipeline was to be left in operation for a further period of years. A transformer fire in 2004 resulted in GBB having to replace the machinery set immediately in order to minimise the loss of generating capacity. The new machinery set was to be designed to suit the future pressure pipeline. In winter 2004/2005 the generator building was renovated and adapted to meet the requirements of the new machinery set. The plant went back into operation at the end of April 2005, about a year after the fire.

In parallel with the replacement of the machinery set, GBB gave the engineering consortium of IUB Ingenieur-Unternehmung AG Bern (of Berne) and Huggler + Porta AG (of Interlaken) the job of working out a construction and requirements project for the replacement of the pressure pipeline. GBB wanted to replace the pressure pipeline in winter 2010/2011. To provide mechanical protection, to improve the look of the landscape and to reduce the cost of maintenance, most of the new pipeline was to be buried. GBB was willing to accept the extra

costs thereby incurred due to the increased amount of excavation work because electricity output could be increased due to lower pressure losses in the new pipeline. However, the project was delayed because of a legal dispute and invitations to tender for it could therefore not be issued until March 2010.

2 Planning

Parts of the pressure pipeline for the Giessbach power station run through very steep forested terrain. Around 12% of the total length of the pipeline runs down rock walls and steep faces. The pipeline is 736 m long. The route followed by the pipeline drops for a gross distance of 356.4 m, which is equivalent to an average gradient of 48.4 %. In places the terrain is almost inaccessible. The maximum flow rate for generating electricity is 300 L/s. The existing DN 300 pipeline was designed for a maximum pressure of 40 bars. The pipes installed 78 years ago were steel ones with flanged joints. They had no internal corrosion protection and on the outside they had a primer and paint finish. 17 stuffing-box expansion joints were fitted to absorb temperature-related changes in length.

The water intake structure is situated in the Giessbachschlucht gully to the west of Bramisegg. The first section of the pipeline, between the water intake structure and fixed point 3, is buried. From fixed point 3 to the generator house on Lake Brienz it runs above ground. It is supported on 27 fixed points and a number of concrete blocks and steel trusses. Before the final fixed point and the inlet bend it narrows to a nominal diameter of 220 mm. If there are faults or inspection is necessary or inflow is too low, it can be shut off with a ball valve

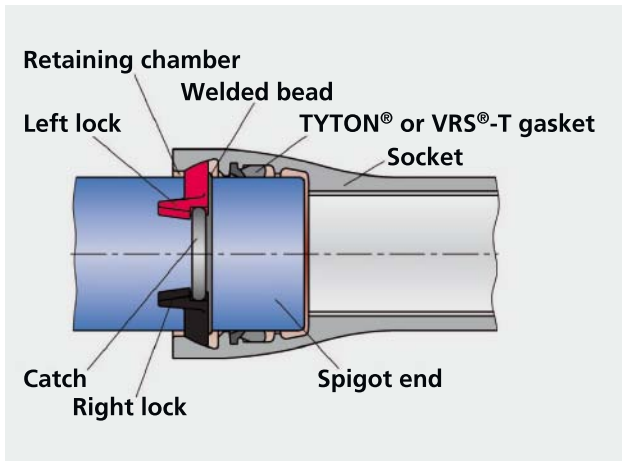

Fig. 1:
The BLS®/VRS®-T push-in joint

(maximum operating pressure 40 bars). Except for the vertical positions of the buried sections, the line followed by the new pressure pipeline is exactly the same as the existing route. This meant that the existing pressure pipeline had to be dismantled and the 27 fixed points and concrete supports had to be demolished.

Over the 60 m at the very top between the trash rack building and the end of the supporting wall, the new pressure pipeline is at a minimal gradient and its maximum pressure rating is 10 bars. This section of the pipeline was laid in DN 500, PN 10 fibre-reinforced plastic pipes to Swiss standard SN 10.000. The transition to DN 400 ductile iron pipes to EN 545 [1] with restrained BLS®/VRS®-T push-in joints (**Figs. 1 and 2**) is situated at the end of the supporting wall. After the change to the ductile iron pipes, the pipeline runs above ground down very steep rocky terrain to fixed point 7 and is fixed in place on concrete supports. Between fixed points 7 and 12, the pipeline is both buried and above ground. Except for a short intervening length of pipeline, the run that followed could be buried until fixed point 25 was reached. At the sheer face just before the generator building, the pipeline is again carried on steel supports.

The pressure pipeline is divided into four pressure ratings and these correspond to the increasingly high hydrostatic load up to the maximum internal pressure of 35.4 bars (356.4 m water gauge). In the bottom part of the route, before the inlet to the generator building, the pipeline is designed for an operating pressure of PFA = 40 bars. The Pelton turbine has jet deflectors and is so designed that, in the event of an emergency shutoff, there will not be a pressure surge. The ball valve closes very slowly.

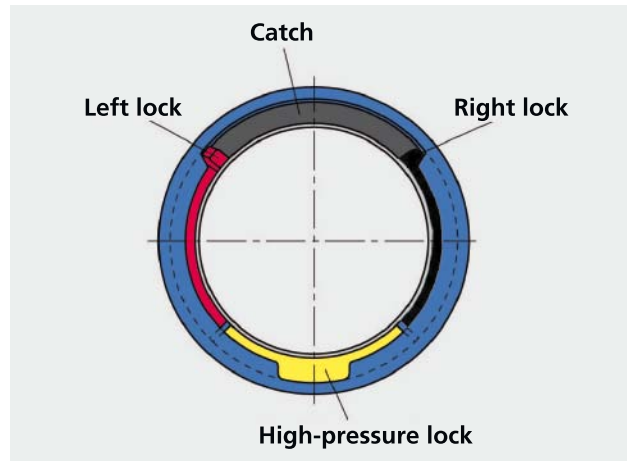

Fig. 2:
Positions of the locks in a BLS®/VRS®-T push-in joint

Because of this there was no need for the margin for pressure surges to be made any larger when the pipeline was being dimensioned.

The ductile iron pipes used for the new pipeline have a cement mortar lining (ZM-A). Approximately 114 m of the new pipeline is installed above ground. On their exterior, the ductile iron pipes intended for this purpose have the standard external protection, namely a zinc-aluminium coating and an epoxy finishing layer, plus insulation of rigid polyurethane foam and a casing tube of HDPE (**Fig. 3**).

The external protection of the pipes used for the buried part of the pipeline consisted of a zinc-aluminium coating plus a cement mortar coating (ZM-U) to EN 15542 [2].



Fig. 3:
Ductile iron pipes with additional insulation of rigid polyurethane foam and a casing tube of HDPE



Fig. 4:
A fixed point on the pipeline



Fig. 5:
The ductile iron pipes being installed in the region of the generator building, working from the top down

Because the new ductile iron pipeline is installed partly above ground and partly in pipeline trenches with only a small earth cover, 26 fixed points are needed to secure it in position. The fixed points are on foundations of solid rock and are secured, where required, by rock anchors (**Fig. 4**).

3 The installation work

Installation took place in the winter months from January to April 2011 when both water levels and electricity output were low.

For transporting the pipes and so on, a temporary goods-carrying cable car with a carrying capacity of 2.5 t to 3.0 t had already been set up at the end of 2010. In parallel with this, the trees were cleared from the route of the pipeline where necessary. Except for the top section between the water intake structure and fixed point 4, the entire route of the pipeline could be supplied with all the requisite hardware and equipment, via the cable car, from the unloading point for lorries. Thanks to this central unloading point it was even possible for a number of laying crews to be used in parallel. After the dismantling of the old pipeline and the demolition of the fixed points, the trench for the new pipeline was excavated. The foundations for the fixed points along the new pipeline were cleaned up and any loose sections of the rock were taken away. The 60 m or so long DN 500, PN 10 section of the pipeline between the trash rack building and the end of the supporting wall was then assembled. The new DN 400 pressure pipeline between fixed point 5 and fixed point 26 (just before the generator building) was

installed from the top down (**Fig. 5**). Care was taken to see that the restrained BLS®/VRS®-T push-in joints stayed locked when this was done.

The concrete fixed points were produced at the same time as the pressure pipeline was being assembled. In the sections installed above ground, one steel support was placed in position for each pipe. Two protective tubes for cables



Fig. 6:
Protective tubes for cables fixed to the ductile iron pipes with pipe clips

also had to be run along with the pressure pipeline. These were fixed to the ductile iron pipes with pipe clips (**Fig. 6**). The protective tubes are of steel along the above-ground sections of the pipeline and of polyethylene along the buried sections.

To protect the pipes, to enhance the landscape and to allow for maintenance the lower section of the pipeline had to be installed with a covering of earth. The height of this cover had to be at least 30 cm and it took the form of back-filling with the native excavated material. The external protection of the ductile iron pipes (the ZM-U coating) is very strong mechanically. Pieces of rock up to 100 mm in diameter were allowable in the material directly covering the pipes. The BLS®/VRS®-T joint is easy and quick to assemble and can be deflected angularly by up to 3°. The laying length of the pipes was 6 m. Curves of minimum radiuses down to 115 m could be laid by deflecting the joints angularly. The installation of bends could sometimes be dispensed with because the pipeline could be matched in an optimum way to the contours of the terrain (**Fig. 7**).



Fig. 7:
Path followed by the DN 400 pressure pipeline

4 To sum up

The installation operation described allowed a demanding structure to be produced. There are many similar projects where ductile iron pipes with the restrained BLS®/VRS®-T push-in joint have proved to be a great success in the past. The ruggedness of the pipes, a safety factor of more than one against the existing internal pressures and the high capacity for bearing external loads are what guarantee great safety and reliability in operation and a long operating life.

The satisfactory way in which all those involved worked together, namely the client (Einwohnergemeinde Brienz), the planners (Ingenieurgesellschaft IUB-HUPAC), the contractor (Implenia AG) and the supplier of the ductile iron pipe system (TMH Hagenbucher AG), made it possible for the scheduled installation deadline to be met in spite of some difficult constraints and for the pipeline to go into operation as planned.

References

- [1] EN 545
Ductile iron pipes, fittings, accessories and their joints for water pipelines – Requirements and test methods
2010
- [2] EN 15542
Ductile iron pipes, fittings and accessories – External cement mortar coating for pipes – Requirements and test methods
2008

Author

Wolfgang Rink
Duktus Rohrsysteme Wetzlar GmbH
Sophienstraße 52–54
35576 Wetzlar, Germany
Phone: +49 (0)27 76/10 55
E-mail: w.rink@duktus.com

Penstock pipelines for small hydroelectric power stations in the Alpine region

by *Andreas Moser*

1 The Frankbach power station at the end of the beautiful Ahrntal valley

For more than 80 years now, the power of water has been used to generate electricity in the high-altitude health resort of St. Johann in the Ahrntal valley. The Artur Kirchler family built a hydroelectric power station on the upper reaches of the little river called the Frankbach and in this way made the village in South Tyrol one of the first in the region that was able to be supplied with electricity.

In 2008, the decision was made to replace this superannuated power station with a new and substantially larger one. After long negotiations, the private company operating the power station was given the concession to build a new one and received consent for correspondingly larger volumes of water to be taken from the Frankbach.

1.1 Larger volumes of water = bigger pipes

The increase in the amount of water withdrawn to 350 L/s necessarily involved the use of pipes of a larger size for the penstock pipeline. From DN 400 it was necessary to upsize to DN 600. Added to this was the fact that the old pipeline of steel pipes was leaking at a number of points and there was no assurance that the station could continue to operate reliably.

1.2 Complicated conditions imposed by the terrain

The route followed by the pipeline was a total of 1,300 m long and surveys of the ground made in the course of the planning work had shown that there was hard granite rock almost all the way along it. So, for the pipeline to be fitted into the terrain successfully, it was clear even

beforehand that there would be areas where the laying work would be impossible without blasting with explosives.

1.3 No alternative to the ductile iron pipe

In view of these extremely difficult conditions set by the terrain (**Figs. 1 and 2**), there could be no compromise about the material chosen for the pipes. The company operating the power station therefore decided that the choice had to be ductile iron pipes with the restrained BLS® push-in joint (**Figs. 3 and 4**). The work done beforehand to design the pipeline was done jointly with the company that would be installing it.

In the areas where blasting was essential and where the excavated material available for backfilling the pipeline trench would therefore only be coarse fragments of rock, ductile iron pipes with a fibre-reinforced cement mortar coating (ZM-U) were used (**Fig. 5**).

The difference in altitude between the water intake structure on the upper reaches of the Frankbach and the newly built turbine house is 340 metres. The new penstock pipeline, of wall-thickness classes K 9 and K 10, thus had to withstand a static operating pressure of 34 bars.

It is true that the laying of the pressure pipeline wasn't exactly child's play given the difficult topography and the blasting that had to be done, but it was accomplished in 10 weeks without any undesirable incidents, not least because of the ease with which the BLS® pressure pipes can be handled. After a successful pressure test, the pipeline went into operation in April 2010, thus enabling the Frankbach hydroelectric power station, with its two Pelton turbines (a smaller one (100 KW) for wintertime operation and a larger one (800 KW) for summertime operation)



Fig. 1:
Installing the ductile iron pipeline with the help of a walking excavator



Fig. 2:
Very cramped conditions for Installing the ductile iron pipes



Fig. 3:
Installing the DN 600 ductile iron pipes together with empty tubes



Fig. 4:
The penstock pipeline connected to the de-sander by means of a flanged spigot



Fig. 5:
The pressure pipeline runs through a wall of rock which has been blasted away

to provide an adequate supply of energy for the municipality of St. Johann and its 700 inhabitants.

The major proportion of the approximately 4 million kWh that is generated every year is fed onto the public grid.

1.4 Technical data on the Frankbach power station

- 900 m of DN 600, K 9, ductile iron pipes with restrained BLS® push-in joints and a cement mortar lining (ZM-A) plus an epoxy external finishing layer
- 400 m of DN 600, K 10, ductile iron pipes with restrained BLS® push-in joints and a cement mortar lining (ZM-A) plus a fibre-reinforced cement mortar coating (ZM-U)
- Catchment area: 15 km²
- Net head: 340 m
- Water flow rate: 40-350 L/s
- Average nominal output: 580 kW
- Annual output: 4,000 MWh.

2 The Himmelreich hydroelectric power station on the Sengesbach in the municipality of Freienfeld in South Tyrol

This construction project consisted of the building for Flans Energie GmbH of the Himmelreich hydroelectric power station on the little Sengesbach river in the municipality of Freienfeld.

The construction time amounted to 12 months from October 2009 to the commissioning in October 2010.

2.1 Difficult conditions imposed by the terrain

Some of the work was done in very difficult weather conditions (**Fig. 6**).

In the steep lower region of the penstock pipeline, the DN 500 ductile iron pipes with restrained push-in joints had to be moved to their destination on a goods-carrying cable car whose cable had been specially installed for the purpose (**Fig. 7**).

In the upper region, the route followed by the pipeline runs almost entirely through rocky terrain (**Fig. 8**).

2.2 No alternative to ductile iron pipes

The following were the conditions which decided the choice of ductile iron as the material for the penstock pipeline:



Fig. 6: Bad weather conditions making installation very difficult



Fig. 7: The ductile iron pipes being brought in by a goods-carrying cable car



Fig. 8:
The DN 600 ductile iron pressure pipeline in very rocky terrain



Fig. 10:
The turbine house built into the steep slope



Fig. 9:
The final ductile iron pipe before the connection to the turbine house

- This power station is a “run of the river” hydroelectric power station, i.e. it has no reservoir because it only ever uses a small proportion of the incoming water. The water intake structure and the de-sanding basin are underground structures, with the intake structure planned as a “Tyrolean weir” and the de-sanding basin as a twin-basin type. The design selected for the intake structure means that there is no interference with the natural flow of the water because the water is not retained or dammed. This type of intake structure also has a powerful self-cleaning action and therefore requires little maintenance.
- The buried pressure pipeline is of DN 600 and DN 500 nominal sizes and measures approx. 1,990 m in overall length. It is used both for the power station and for irrigation. For its first 1,680 m (the DN 600 section), it runs along the existing route followed by the forest track and farm road. The rest of the pressure pipeline (the DN 500 section), which runs to the turbine house, was installed in the agricultural field and forest area.
- The turbine house was built into the slope (**Figs. 9 and 10**). Now that it has been completed, all that can be seen are the front facade and a small part of the side-walls. The water is returned directly to the Sengesbach. Two machinery sets have been provided in the form of Pelton turbines with directly coupled generators to enable the highest possible efficiency to be achieved in spite of the wide variations in the flow rate of the driving water (31-380 L/s) (**Figs. 11 and 12**).



Fig. 11:
Transition from a ductile iron pipe to the bifurcation pipe made with a flanged joint



Fig. 12:
From the bifurcation pipe, the driving water is distributed to two Pelton turbines

2.3 Technical data on the Himmelreich power station

- 1,680 m of DN 600, K 9, ductile iron pipes with restrained BLS® push-in joints and a cement mortar lining (ZM-A) plus an external finishing layer of bitumen
- 310 m of DN 500, K 10, ductile iron pipes with restrained VRS®-T push-in joints and a cement mortar lining (ZM-A) plus an external finishing layer of polyurethane
- Catchment area: 11.26 km²
- Net head: 346.5 m
- Water flow rate: 31-380 L/s
- Average nominal output: 640 kW
- Annual output: 4,512 MWh.

Author

Ing. Andreas Moser
Duktus Tiroler Rohrsysteme GmbH
Innsbrucker Straße 51
6060 Hall in Tirol, Austria
Phone: +43 (0)52 23/50 34 53
E-mail: andreas.moser@duktus.com

Companies involved in the work on project 1 – the Frankbach hydroelectric power station

Client

Josef Kirchler
St. Johann Nr. 3
39030 Ahrntal, Italy

Planner

von Pföstl & Helfer GmbH
Ingenieurbüro
Tschermsersweg 1/1
39011 Lana, Italy
Phone: +39 (0)4 73/56 50 07
E-mail: info@ingph.it

Construction and installing company

Brunner & Leiter
Weissenbach Nr. 75/C
39030 Weissenbach, Ahrntal, Italy
Phone: +39 (0)4 74/68 06 40
E-mail: info@brunner-leiter.com

Companies involved in the work on project 2 – the Himmelreich hydroelectric power station

Client

Flans Energie GmbH
Flans 38
39040 Freienfeld, Italy

Planner

Troyer AG – Ernst Troyer Engineering
Karl v. Etzel Straße 2
39049 Sterzing, Italy
Phone: +39 (0)4 72/76 51 95
E-mail: info@troyer.it

Construction and installing company

Bauunternehmen Roland Gufler GmbH
Handwerkerzone 3
39013 Moos in Passeier, Italy
Phone: +39 (0)4 73/64 85 06
E-mail: info@roland-gufler.it

Electricity from water power

Ductile iron pipelines for power stations – important components for generating renewable energy

by Wolfgang Rink

1 Electricity from water power

Electricity can be generated from water power where there is an adequate supply of water available at a sufficiently high altitude and there is a large enough head relative to the power station. The output of a hydroelectric power station depends mainly on the flow rate of the water available and on the existing head, although other factors such for example as the efficiency of the turbine and generator also play a certain part in it. Pipelines for power stations, i.e. penstock pipelines, are generally high-pressure pipelines. The Swiss Alps are tailor-made for the generation of renewable energy from water power. However, because of the extreme conditions set by their terrain they do make very exacting demands on the consulting engineers doing the planning, on the company doing the installation work but above all on the material used for the pipes. What this material is required to do is to meet the extreme demands which are made for functionality and installability.



Fig. 1:
Adapting the ductile iron pipeline to the terrain and the route

2 Advantages of ductile iron pipe systems

Ductile iron pipe systems to EN 545 [1] are outstandingly well suited to the installation of penstock pipelines under extremely demanding conditions. The reasons for this are, in particular:

- the ductile iron, a rugged material which provides large safety margins,
- the very high safety given by system components tested in the factory,
- no on-site welding or on-site testing of welds (this saves time),
- using a sophisticated range of fittings, the different changes of direction and connections to valves and structures can all be made with one material (**Fig. 1**),
- fast installation regardless of the weather with the tried and tested restrained BLS® push-in joint (**Fig. 2**),
- the joint can be deflected angularly by up to 5° and this allows bends and assembly time to be saved at changes of direction, while at bends and angled connections additional forces due to any pressure surges which may occur can be transmitted directly into the ground without any added thrust blocks (**Fig. 3**),
- the cement mortar coating (ZM-U) applied in the factory can be used in soils of all levels of corrosiveness and is also of high mechanical strength; stones of up to fist size are allowable in the material directly surrounding the pipes,
- provided it suits the given operating pressures, the wall thickness required can be selected almost as desired.

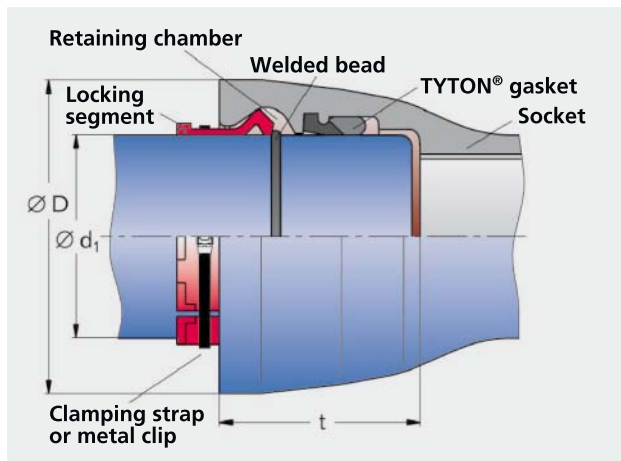

Fig. 2:
The DN 600 restrained BLS® push-in joint



Fig. 3:
Used a restrained fitting in the form of a bend to deflect a ductile iron pipeline angularly to adapt it to the route

3 Penstock pipeline projects

Described below as examples are four Swiss penstock pipeline projects which were carried out in 2011 and 2012 in Alpine terrain. The characteristics of the projects are summarised in **Table 1**.

Table 1:
Summary of the most important characteristics of the projects

	Project 1 "Sagenbach" penstock pipeline	Project 2 "Tambobach" penstock pipeline	Project 3 "Niedererbach" penstock pipeline	Project 4 "Buoholzbach" penstock pipeline
Client	Axpo AG, Baden	Alpiq and Gemeinde Splügen	tbgs (Technische Betriebe Glarus Süd), Schwanden	EWN Kantonales Elektrizitätswerk Nidwalden, Stans
Consulting engineers	Widmer Ingenieure AG, Chur	Entegra Wasserkraft AG, Chur	Jackcontrol AG, Glarus	IM Maggia Engineering SA, Locarno
Installing company	Bauunternehmung Vetsch, Klosters	Mengelt, Splügen/ Vitali, Lenzerheide consortium	Tümpi AG Bauunternehmung, Mitlödi	Arnold AG, Schatt-dorf/Mathis Sanitär und Heizung AG, Wolfenschiessen consortium
Length of pipeline [m]	912	1.820	1.980	1.980
Nominal size	DN 600	DN 500 and DN 600	DN 600	DN 600
Coating	ZM-U	ZM-U	ZM-U	ZM-U
Push-in joint	BLS®	BLS®	BLS®	BLS®
Wall-thickness class	K 9, K 12 und K 14	K 9 und K 12	K 9, K 12 and K 14	K 9 to K 12
Operating pressure [bar]	54	42	45	64
Installation period	July to August 2012	August to November 2011	December 2011 to April 2012	June 2011 to December 2012

3.1 Project 1 – The “Sagenbach” penstock pipeline, Tschierschen, canton of Graubünden

Because of the difficult topographic conditions prevailing along the route, the ductile iron pipes had to be brought in and assembled with the help of a K-Max type helicopter along the entire length of the pipeline (Figs. 4 and 5).



Fig. 4:
The “Sagenbach” penstock pipeline: pipe transport by a K-Max helicopter



Fig. 5:
The “Sagenbach” penstock pipeline: the DN 600 ductile iron pipes being assembled in difficult terrain

3.2 Project 2 – The “Tambobach” penstock pipeline, Splügen, canton of Graubünden

This was another pipeline along whose route there was some extreme terrain. This was why this was another operation where the pipes had to be moved and assembled with the help of a helicopter along the entire length of the pipeline. The pipe length of 6 m was ideal for this and the pipe joints could be assembled and deflected quickly so, as in the case of project 1, all this work could be done without any problems (Figs. 6, 7 and 8).

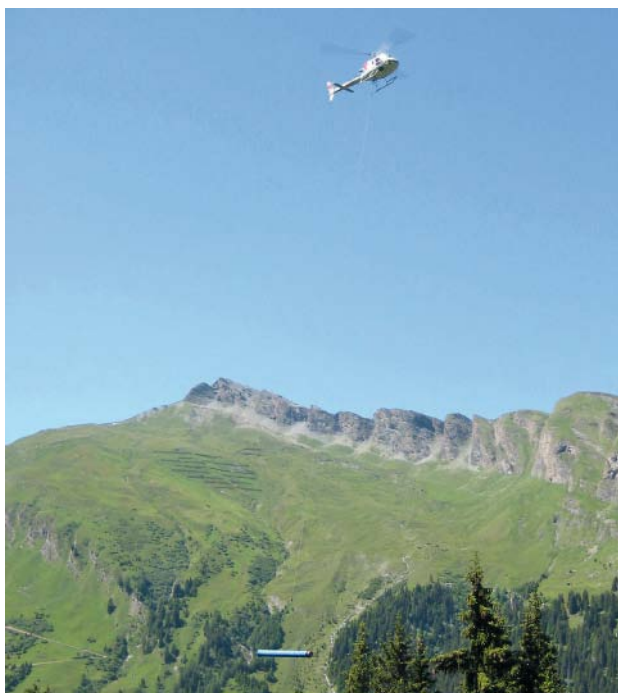

Fig. 6:
The “Tambobach” penstock pipeline: a pipe being brought in by helicopter



Fig. 7:
The “Tambobach” penstock pipeline: a ductile iron pipe on the approach flight to the installation site



Fig. 8:
The “Tambobach” penstock pipeline: on-site assistance by the excavator with the installation of the ductile iron pipes

3.3 Project 3 – Replacement of the “Niedererbach” penstock pipeline, Schwanden, canton of Glarus

The existing pipeline was showing its age and was replaced by a new DN 600 pressure pipeline (**Fig. 9**). Because of its larger free hydraulic cross-section, the new pipeline gives an increase in output of more than 6%. There was no problem in installing the new pipeline in the winter months. During this time, outside temperatures down to -20° were measured. The pipeline was installed in the conventional way in a pipeline trench excavated by construction machines. The pipeline has been in trouble-free operation since mid-May (**Fig. 10**).



Fig. 9:
The “Niedererbach” penstock pipeline: demolishing the old pressure pipeline



Fig. 10:
The “Niedererbach” penstock pipeline: open trench installation – the DN 600, K 9, ductile iron pipes being installed with the help of the excavator

3.4 Project 4 – The “Tambobach” penstock pipeline, Splügen, canton of Graubünden

In the steep bottom part of the terrain, most of the pipes were installed from goods-carrying cable car. Laying rates of 120 m per day were achieved (**Figs. 11, 12 and 13**). For this operation, the TMH Hagenbucher AG company of Zurich supplied special cut pipes produced by itself with the welded beads already applied. In the top part, a run of ductile iron pipes 81 m long was pulled into a bore made through the solid rock.



Fig. 11:
The “Buoholzbach” penstock pipeline:
Preparations completed for assembling a
BLS® push-in joint



Fig. 13:
The “Buoholzbach” penstock pipeline: open trench
installation – the ductile iron pipes being installed
with the help of the excavator



Fig. 12:
The “Buoholzbach” penstock pipeline:
looking along the route of the pipeline –
ductile iron pipes with a cement mortar coating

References

- [1] EN 545
Ductile iron pipes, fittings, accessories and
their joints for water pipelines –
Requirements and test methods
2010

Author

Wolfgang Rink
Duktus Rohrsysteme Wetzlar GmbH
Sophienstraße 52-54
35576 Wetzlar, Germany
Phone: +49 (0)27 76/10 55
E-mail: w.rink@duktus.com

Installation of a DN 300 drinking water pipeline by the HDD technique – compulsory retirement for a pipeline bridge crossing a river

by Marc Winheim

1 Introduction

Our travels now take us to France, or to be more exact to the Champagne-Ardenne region and the town of Saint-Dizier, which has some 30,000 inhabitants. This quiet little town lies on the river Marne which, after 514 km, flows into the river Seine near Paris. The Marne is 30 m wide at Saint-Dizier and the drinking water pipeline between the Ajots reservoir and the Boulevard de la Marne was suspended below a footbridge (**Fig. 1**) over it. Because of age-related infirmities the bridge had already been closed to pedestrians for some years. There was a fear that the DN 300 grey cast iron drinking water pipeline suspended from it might also not be sufficiently safe now.

2 The planning

For the civic authorities of Saint-Dizier there was no question of having a new footbridge built with a drinking water pipeline suspended



Fig. 1:
The footbridge over the river Marne

below it. The decision was therefore made to make a crossing below the Marne by a trenchless installation technique and in so doing to enjoy the thermal advantages which a buried pipeline has over a bridge pipeline suspended out in the open air. It was decided in the planning phase that the crossing below the Marne would be made by the steered horizontal directional drilling (HDD) technique, using ductile iron pipes with restrained push-in joints.

From the initial design it was clear that, as a function of the radius of the bore, the new pipeline would have to be approx. 100 m long to reach the connecting points on the river banks. The radius planned for the bore was $R = 115$ m (**Fig. 2**). The restrained BLS®/VRS®-T joint allows an angular deflection of 4° which, with pipes 6 m long, is equal to a minimum radius of curvature of 86 m. For a radius of $R = 115$ m, calculation gave an angular deflection of

$$\alpha = 2,99^\circ.$$

How the angular deflection present at each joint was calculated:

$$\alpha = \sin^{-1} \frac{L}{R} = \sin^{-1} \frac{6 \text{ m}}{115 \text{ m}} = 2,99^\circ \quad (1)$$

3 The material

The selection of the most suitable material has a crucial part to play in a project of this kind. It was not difficult for the decision to be made to use ductile iron pipes. Among the crucial criteria were

- the high safety margins
- the easy assembly
- readily availability.

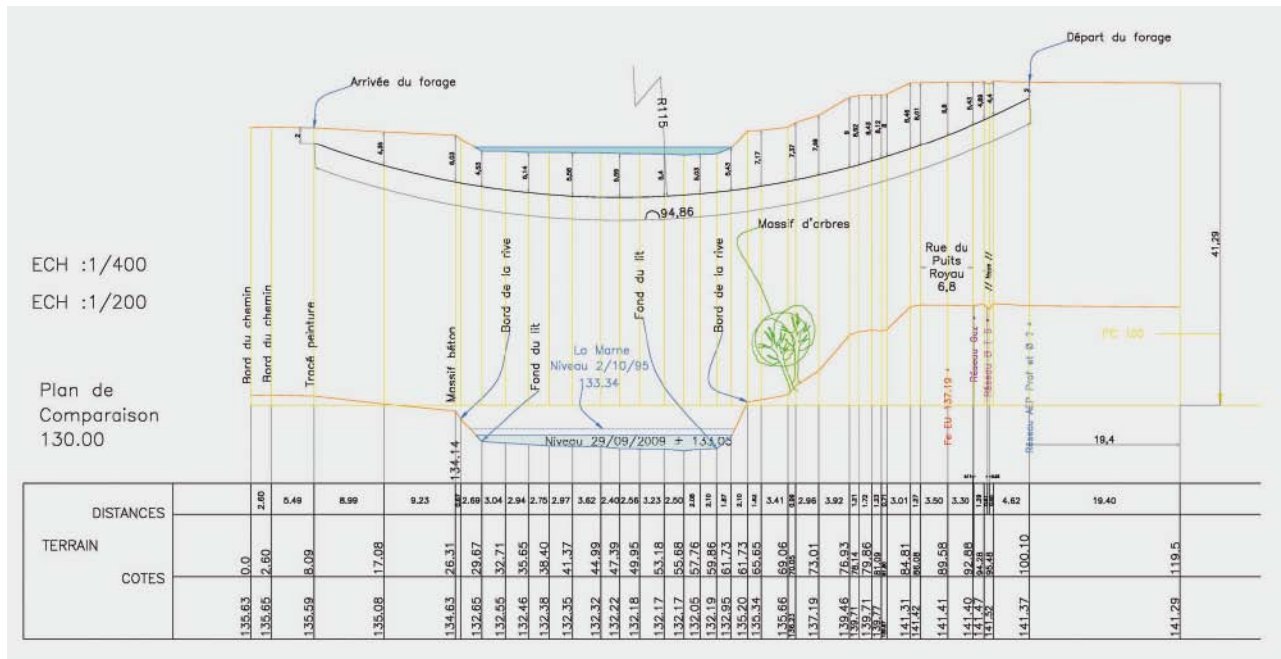

Fig. 2:
Drawing of the bore path

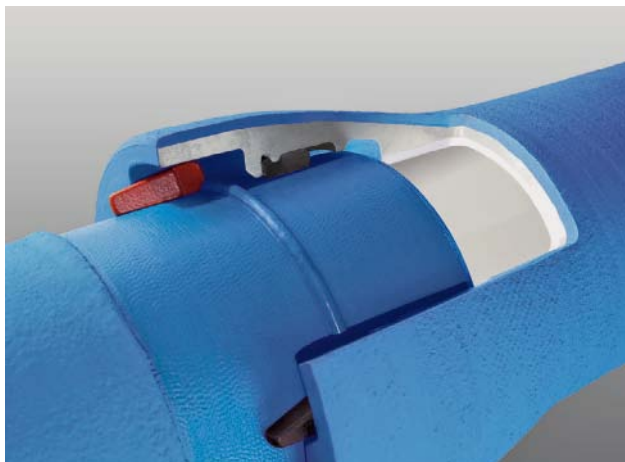

Fig. 3:
The BLS®/VRS®-T push-in joint with a cement mortar coating (ZM-U)



Fig. 4:
A pre-assembled pipe string with sheet-metal cones slid over the joints

The pipes used were ductile iron pipes to EN 545 [1] with the BLS®/VRS®-T push-in joint and with a cement mortar coating (ZM-U) to EN 15542 [2] as external protection (**Fig. 3**). The cement mortar coating is equal to the mechanical and chemical stresses which typically exist.

The pipes are lined as standard with cement mortar based on blast furnace cement. This purely mineral lining is free of organic additives. Cement mortar linings have an active and a passive protective effect. The active effect is based on an electrochemical process. Water penetrates into the pores of the cement mortar and the pH of the water rises to a level > 12 as

a result of the absorption of free lime from the mortar. It is impossible for cast iron to corrode in this pH range. The passive effect results from the physical separation which exists between the cast iron wall of the pipe and the medium flowing through it.

4 Doing the work

Once the pipes had made the journey from the pipe manufacturer to Saint-Dizier, the preparations were made for assembling them. A conscious decision was made in this case to use a pre-assembled pipe string (**Fig. 4**) to shorten the

time taken by the pulling-in. There was plenty of space available so the pipe string could be pre-assembled to its full length of 102 m. The installing company needed only one working day to assemble the complete pipe string including the fitting of the shrink-on sleeves and sheet-metal cones. At the same time, the pilot bore was made under the Marne by a directional drilling machine with a pull-back force of 40 t.

The pre-assembled pipe string was coupled to the drilling string by a special BLS®/VRS®-T traction head (Fig. 5). In a second step, the diameter of the pilot bore was increased to 600 mm with the help of an upsizing head. The maximum outside diameter of the pipes was 410 mm at the external contour of their sockets. The annular gap between the bored passage and the pipeline produced by the oversize which was cut, was filled by the drilling fluid used.

A swivel between the upsizing head and the traction head ensured that the rotary movement of the drilling string was not transmitted to the pipe string.

As the pipe string was pulled into the bored passage, the pipes slid over the surface of the ground (Fig. 6). As this took place, the cement mortar coating to EN 15542 [2] applied in the factory showed impressive evidence of its ability to withstand mechanical loads. There were sometimes large stones in the surface of the ground and the pipe string was pulled over these. These stones however completely failed to cause any damage to the coating of the pipes (Figs. 7 and 8).



Fig. 5:
Traction head plus swivel assembled to pipes



Fig. 7:
The surface of the ZM-U coating under stress



Fig. 6:
Pulling in the pipe string



Fig. 8:
A stone causing the stress

The allowable tractive force on the DN 300 BLS®/VRS®-T push-in joint is 380 kN [3]. Because of the upsizing of the bored passage to 600 mm and the relatively large radius of the bore, the tractive force as measured at the traction machine rose to only 200 kN, meaning that there was an adequate safety margin from the allowable tractive force. The pipe string pulled in was tested at 21 bars and then connected into the existing pipeline network.

5 To sum up

The installation site attracted the interest of the local population. Both the regional and the trade press reported on the crossing made below the Marne with ductile iron pipes by the trenchless horizontal directional drilling technique, a technique which is becoming increasingly widely used not just in France. What was most convincing were the advantages of the BLS®/VRS®-T push-in joint.

References

- [1] EN 545
Ductile iron pipes, fittings, accessories and their joints for water pipelines – Requirements and test methods
2010
- [2] EN 15542
Ductile iron pipes, fittings and accessories - External cement mortar coating for pipes - Requirements and test methods
2008
- [3] Duktus Manual –
Trenchless installation techniques using ductile iron pipes
2011-09

Author

Marc Winheim
Duktus Rohrsysteme Wetzlar GmbH
Anwendungstechnik
Sophienstraße 52-54
35576 Wetzlar, Germany
Phone: +49 (0)64 41/49-12 49
E-mail: marc.winheim@duktus.com

Horizontal directional drilling with ductile iron pipes – process description, advantages, fields of application, examples

by *Stephan Hobohm*

1 Foreword

There has been a close connection between the development of the horizontal directional drilling (HDD) technique and ductile iron pipes. Back in 1993, Nöh [1] conducted some exploratory tests in which 60 m long DN 150 pipelines with positive locking push-in joints were installed by the HDD technique. They were then withdrawn again from the bored passage to allow the stresses which had occurred to their surfaces to be assessed. The excellent results provided the justification for a 2 x DN 150 double culvert pipeline about 200 metres long which was pulled in under the river Mosel in 1994 near Kinheim, partly through rocky subsoil.

After this satisfactory experience, development went ahead at a very rapid pace (**Fig. 1**). In 1996 the pipes were of DN 500 size in Oranienburg [2], in 2000 the bar was raised to DN 600 [3] and in 2003 DN 700 pipes were pulled in by the horizontal directional drilling technique in the Netherlands [4]. For diameter, the current world record for ductile iron pipes is approximately 500 meters of DN 900 pipes in Valencia in Spain [5]. The biggest culvert pipeline pulled in to date in Germany is a 486 m long one of DN 700 nominal size which was installed in 2010 in Berlin [6]. In parallel with the above, the German Technical and Scientific Association for Gas and Water (DVGW) was developing technical rules for the technique, in the form of Arbeitsblatt GW 321 [7].



Fig. 1: The Albert Canal near Geel in Belgium, awaiting the installation of a DN 500 ductile iron culvert pipeline

There is an international standard for the HDD technique for ductile iron pipes up to DN 1200 [8].

2 Process description

The horizontal directional drilling (HDD) technique is the most widely used trenchless technique for installing new pressure pipelines for gas and water supply. DVGW Arbeitsblatt GW 321 [7] gives rules for it relating to requirements, quality assurance and testing.

The sequence of operations in the HDD technique is generally divided into the following three successive steps:

- a steered pilot bore,
- an upsized bore or bores and
- pulling-in.

3 The pilot bore

This is the first step in producing a bored passage, running from the starting point to the target pit, into which the string of pipes can be pulled. The pilot bore is driven under steered control by a drilling head at the tip of a drilling string. Emerging at high pressure from the drilling head as it drives is an aqueous suspension of bentonite, the so-called drilling mud, which is pumped through the drilling string to the drilling head by the drilling machine. The drilling

mud serves both to carry away the material which is cut away and to support the bore. There are different designs of drilling head for all types of soil (**Figs. 2 and 3**). In sandy soils, all that is generally needed for detaching and carrying away the cuttings are the outlet nozzles. In rocky soils, drilling heads fitted with roller-equipped chisels can be used. The pilot bore is steered by controlled rotation of a bevelled steering surface on the drilling head. This surface moves off-line and it can be forced to move off-line in the desired direction by rotating it. The actual position of the drilling head is detected above the path of the bore by means of radio signals from a transmitter housed in the drilling head. Any deviations from the desired line are corrected by appropriate steered movements. Today, the accuracy of steering is so high that, after being driven for a length of more than 1000 metres, pilot bores can be made to arrive within a target area measuring only a square metre in size.

4 The upsized bore or bores

If the pilot bore needs to be upsized, suitable tools are used to upsize it, in a number of stages, to a diameter large enough for the pulling-in of the medium-carrying pipeline. For this purpose, an upsizing head is fitted to the pilot-drilling string, the size and configuration of this head being governed by the particular soil



Fig. 2:
Preparing for the pilot bore



Fig. 3:
Arrival at the end of the pilot bore

conditions and the size of the pipeline which is subsequently going to be pulled in. The upsizing head (**Fig. 4**) is pulled through the pilot bore while rotating continuously and in this way it enlarges the size of the pilot bore. The soil which is cut away is carried out with the drilling mud and this latter supports the bore at the same time. The upsizing process is repeated with increasingly large heads (**Fig. 5**) until the bored passage is of the desired inside diameter. With ductile iron pipes the diameter of the bored passage depends on the outside diameter of the sockets, on the length of the bore and on the planned radius of curvature. With short lengths and large radiuses, the oversize on top of the diameter of the sockets is around 20 % to 30% while with greater lengths and tighter radiuses it is 40 % to 50 %.



Fig. 4:
An upsizing head

An example:

Geel-Westerloo, Belgium Albert Canal culvert pipeline, 2010

- DN 500
- BLS®/VRS®-T push-in joints
- Cement mortar coating (ZM-U)
- D_{outside} (socket inc. ZM-U): ~ 550 mm
- D_{upsized} : $1,5 \times 550 \text{ mm} = 825 \text{ mm}$
→ gewählt: 900 mm

5 Pulling-in

Once the bored passage has reached its final diameter, the string of pipes can be pulled in. A reaming tool, then a swivel joint that stops the string of pipes from turning with the reaming tool, and then a traction head matched to the pipes that are going to be pulled in, are fitted to the drilling string which is still in the passage. The traction head is connected to the string of pipes by positive locking. The maximum possible length of the string of pipes to be pulled in depends on local conditions. To find it, it is necessary to make an estimate of the tractive force which can be expected. According to Dr. R. Kögler and Dipl.-Ing. H. Lübbers, this can be done with the following empirical formula:

$$F = (L + D - K) \cdot X \text{ [kN]} \quad (1)$$

F = estimated tractive force [kN]

L = length of bore [m]

D = pipe diameter [mm]

K = correcting value = 500 [kN]

X = soil factor

- soils well suited to HDD → $X = 0,5$
- normal soils → $X = 1,0$
- difficult soils → $X = 1,5$

An example:

Geel-Westerloo, Belgium Albert Canal culvert pipeline, 2010

- DN 500
- Length: 410 m
- $F = (410 + 500 - 500) \cdot 0,75 = 307 \text{ kN}$
→ expected tractive force
- Tractive force actually reached: 330 kN

The maximum possible length of the pipe string can then be found from the estimated tractive force, assuming the latter complies with the values for allowable tractive force given in Table A.7 of DVGW Arbeitsblatt GW 321 [7], and from the weight of the pipe string. It has been found in practice that the tractive forces which occur are usually in the range of 40% to 70% of the weight of the pipe string.

To keep the tractive forces which occur as low as possible, it may be necessary for the pipeline for pulling-in to be ballasted at nominal sizes of DN 300 and above. If not ballasted, the medium-carrying pipes would float up in the bored passage and their crowns would rub against the passage and thus increase the tractive forces.



Fig. 5:
Arrival of the upsizing head in the target pit

Two options are available for ballasting:

1. **Use of a water-filled ballasting pipeline**
The ballasting pipeline is pulled into the medium-carrying pipeline before the pulling-in proper begins. The nominal size of the ballasting pipeline depends on the expected buoyancy of the medium-carrying pipeline. The ballasting should make the weight of the pipe string roughly equal to or greater than its buoyancy. There is an impressive description of the method of ballasting with a ballasting pipeline in [3].
2. **The medium-carrying pipeline filled with water**
This is the commonest method used with ductile iron pipes, which are generally installed by pipe-by-pipe assembly (Section 6, The pipes of the pipeline). However, this means that the weight-induced force is not evenly distributed for as long as the medium-carrying pipeline is not completely full. The water collects at the lowest point in the medium-carrying pipeline (usually

the lowest point in the culvert pipeline) and pulls it down there. Hence it is only at this point that the friction occurring is minimised.

However, ballasting is not always needed at nominal sizes of DN 300 and above. Depending on the bore path and length it may even be dispensed with at quite large nominal sizes. The nominal size of the culvert pipeline below the Albert Canal near Geel in Belgium was DN 500 and it was pulled in without ballasting. The same was also true for example of the DN 900 culvert pipeline in Valencia and the DN 600 one in Berlin-Wulheide.

As well as the tractive force, what also has an important part to play is the radius which is planned or possible for the bore. This is determined by:

- the drilling string,
- the pipes and
- the soil and the local conditions.

Under Table A.7 of GW 321 [7] the positive locking push-in joints which need to be used for the HDD technique (e.g. the BLS®/VRS®-T joint) can be deflected angularly by between 2° and 3° depending on the nominal size. With ductile iron pipes 6 m long, this is equivalent to curves with minimum radiuses of 115 m to 172 m. However, depending on the design, allowable angular deflections different from this are also possible. From DN 80 to DN 150 the BLS®/VRS®-T push-in joint for example can be deflected by up to 5°. This means a minimum radius of curvature of only 69 m (**Table 1**).

In the case of curves in three dimensions, i.e. curves which extend in both the vertical and horizontal directions, the combined radius can be calculated as follows

$$R_{comb.} = \sqrt{\frac{R_h^2 \cdot R_v^2}{R_h^2 + R_v^2}} \text{ [m]} \quad (2)$$

The combined radius is smaller than the individual radiuses. With regard to the height of cover, it should not be less than a minimum of 5 m or 10-15 times the diameter of the pipes.

Drilling mud is also pumped through the drilling string when the pipeline is being pulled in. It emerges from the reaming tool and as it does so enables the cuttings to be carried away and it reduces the frictional forces at the same time. The forces acting on the string of new pipes as it is pulled in have to be measured and a record has to be kept of them.

6 The pipes of the pipeline

Ductile iron pipes to EN 545 [9] (for drinking water) or EN 598 [12] (for sewage) are particularly well suited to trenchless laying by the HDD technique. The first crucial feature which may be mentioned is the material of the pipes themselves. Ductile iron has the ability to withstand

Table 1:
Technical data and assembly times for the BLS®/VRS®-T push-in joint

DN	Allowable operating pressure PFA [bar] ¹	Allowable tractive force F _{zul.} [kN] ²		Possible angular deflection at joints ³ [°]	Min. radius of curves [m]	Number of assemblers	Assembly time		
		DVGW	Duktus				without joint protection [min]	when using a protective sleeve [min]	when using a shrinkable sleeve [min]
80 *	110	70	115	5	69	1	5	6	15
100 *	100	100	150	5	69	1	5	6	15
125 *	100	140	225	5	69	1	5	6	15
150 *	75	165	240	5	69	1	5	6	15
200	63	230	350	4	86	1	6	7	17
250	44	308	375	4	86	1	7	8	19
300	40	380	380	4	86	2	8	9	21
400	30	558	650	3	115	2	10	12	25
500	30	860	860	3	115	2	12	14	25
600	32	1.200	1.525	2	172	2	15	18	30
700	25	1.400	1.650	1,5	230	2	16	–	31
800	16	–	1.460	1,5	230	2	17	–	32
900	16	–	1.845	1,5	230	2	18	–	33
1.000	10	–	1.560	1,5	230	2	20	–	35

¹ Calculations based on wall-thickness class K 9.

Higher pressures and tractive forces are possible in some cases and must be agreed with the pipe manufacturer.

² The tractive forces can be increased by 50 kN when the route followed is straight (max. of 0.5° angular deflection per joint).

High-pressure lock required at DN 80–DN 250.

³ If of the nominal dimensions

* Wall-thickness class K 10



Fig. 6:
A ductile iron pipe with a ZM-U coating



Fig. 7:
Socket protection by a rubber protective sleeve

very high loads without being damaged. It is therefore highly unlikely that the pipe wall will be damaged by articles lying hidden in the earth.

Another crucial feature is the external protection. Under GW 321 [7], ductile iron pipes for the HDD technique are provided with a fibre-reinforced cement mortar coating (ZM-U) at least 5 mm thick to EN 15542 [11] (**Fig. 6**). This is an effective means of preventing mechanical damage to the body of the pipe and can be used in soils of any desired aggressiveness [12].

The third essential for the use of ductile iron pipes by the HDD technique is a positive locking push-in joint. Restrained positive locking push-in joints (e.g. the BLS®/VRS®-T joint) combine functionality, ruggedness and simple, swift and secure assembly. They can be assembled in just a few minutes even under the most adverse conditions, such as ice and snow, and at no great cost or effort. In this way they

shorten the breaks in the pulling-in process that pipe-by-pipe assembly or the assembly of part strings of pipes involves to an almost unbeatable minimum.

At the same time, their material has, under DVGW Arbeitsblatt GW 321 [7], the highest allowable tractive forces of all the usual materials used for the installation of water pipelines. These allowable tractive forces can be applied, in full, immediately the joint has been assembled. When ductile iron pipes are being assembled, it is unknown for there to be any cooling times or reductions in tractive force due to high pipe wall or ambient temperatures or due to protracted pulling-in times. The allowable tractive forces, operating pressures and angular deflections are shown in Table A.7 of DVGW Arbeitsblatt GW 321 [7], or in the manufacturers' catalogues (**Table 1**). If the angular deflections are $\leq 0.5^\circ$ per joint, the values shown can be increased by a further 50 kN.

The operating pressures and tractive forces shown are usually based on wall-thicknesses of wall-thickness class K 9 under EN 545:2006 [13]. Higher values both for operating pressure and for tractive force are possible by, for example, increasing the wall-thickness class.

With regard to protection for the joints, there are the following options:

- a sleeve of heat-shrinkable material to DIN 30 672 [14] with a sheet steel cone
- a sleeve for protecting cement mortar with a sheet steel cone (**Fig. 7**).

7 Variants of the technique

The crucial factor upon which the socket protection selected depends, is which variant of the technique is opted for. Basically, ductile iron pipes can be pulled in by two variant methods:

1. pulling-in of a pipe string or part pipe strings, or
2. pipe-by-pipe pulling-in.

7.1 Pulling-in of a pipe string or part pipe strings

A point in favour of the first variant, the pulling-in of a pipe string, is that the pipe string is first assembled from individual pipes, filled with water, and pressure tested, before then being pulled into the bored passage which has now been completed. For a long time this variant was even stipulated by insurers of installation work because it was considered the safest.

During the pulling-in, there are only brief breaks in the process for the disassembly of the traction string at the machinery end. These times have to be kept as short as possible so that the thixotropic effect does not occur in the drilling mud and cause it to solidify. What is essential for this method is enough space for assembling the pipe string or the part pipe strings lying next to one another. Something that has an adverse effect is the total weight of the pipe string, which increases the tractive forces required due to the friction between the string and the earth below it. This can be reduced by for example sheet metal slideways greased with lubricant on which the pipe string is assembled. Friction can also be reduced with the help of inflated rubber rollers. If there are channels/pipeline trenches filled with water or a bentonite suspension, the string can float in them (**Fig. 8**).

When pipes are joined together into pipe strings by welding, allowance has to be made not only for the actual welding time but also for the extra time needed for the cooling and testing of the welds. The rhythm of the joining operations cannot be synchronised with the disassembly of the drilling string because, if it were, the time involved would cause the drilling mud to soli-

dify due to the thixotropic effect. It is true in general that the pulling-in of pipe strings does away with the advantage that trenchless installation techniques have of highly localised installation sites.

7.2 Pipe-by-pipe pulling-in

Ductile iron pipes are ideally suited to the second variant, pipe-by-pipe pulling-in, because the short pits typical of trenchless installation techniques are all that they need. This is the very place where the advantage of ductile iron pipes with positive locking push-in joints becomes apparent. The time taken to assemble this joint is of a similar shortness to the time needed to disassemble the traction string at the machinery end. Depending on the nominal size, the assembly of a BLS®/VRS®-T push-in joints takes between 5 and 20 minutes. This is the essential advantage of ductile iron pipes when used for trenchless installation techniques. The space needed at the pipe pull-in end is only slightly more than the length of one pipe and installation pits 7 m to 8 m long are generally all that are needed. Otherwise the pipes are assembled on an assembly ramp. A point site becomes possible with pipes assembled in these ways.



Fig. 8:
A pre-assembled pipe string floating in bentonite suspension



Fig. 9:
Assembly on a ramp

No allowance has to be made for forces due to friction against the earth below and it is usually even possible for the next smaller traction machine to be used, something which once again has a beneficial effect on costs. Another advantage of pipe-by-pipe assembly on a ramp (**Fig. 9**) is that the work can be done at eye level, under workshop conditions as it were, which is important from an ergonomic point of view. Also, the assembly of the joints on a ramp some distance away from dirt and sludge is an inestimable advantage as far as the drinking water hygiene constraints and the subsequent release of the pipeline for use are concerned.

It is clear that the gain in speed provided by the variant method which has been described must not be lost due to the fitting of a heat-shrinkable sleeve. This is where the sleeve for cement mortar protection (**Fig. 7**), which can be folded back easily and quickly and which is protected against the unknown roughnesses in the bored passage by a sheet metal cone, comes into its own. Together with the sleeve, the cone is slid over the pipe socket before the pipe is assembled and following the assembly of the joint it is moved into position and folded over if required.

8 Requirements for the installing company

The company which is given the job of carrying out the directional drilling operation must have the requisite qualifications. Evidence of such qualifications is considered to have been provided if the company has a DVGW certificate to DVGW Arbeitsblatt GW 301 [15] or 302 [16], as the case may be, in group GN 2. The company must also have a supervisor who is qualified under DVGW Arbeitsblatt GW 329 [17].

9 To sum up

In their current form, ductile iron pipes with a cement mortar coating and positive locking push-in joints are not only suitable for installation in open trenches but are also an interesting alternative when modern-day trenchless installation techniques such as horizontal directional drilling are going to be used. They combine a very simple design of joint which is able to carry high loads with a coating system which is equal to the demands made on it.

What is more, the pipes will withstand virtually all the external stresses which occur in horizontal directional drilling and according to DVGW Hinweis W 401 [18] their material has by far the longest technical operating life of all those used for pipes.

Ductile iron pipes are the first choice when it comes to making a sustainable investment. That word of this has already got around is proved by the large numbers of installation operations which have been carried over past years and decades with the horizontal directional drilling technique.

Here at a glance are the advantages of ductile iron pipes for horizontal direction drilling:

- can be assembled in all weathers,
- tractive forces do not depend on the outside temperature,
- tractive forces do not depend on the time taken to pull in,
- the full tractive forces can be applied in full immediately following assembly,
- very high allowable tractive forces,
- assembly times per joint of between 5 and 20 minutes,
- radiuses down to 69 m are possible (5° angular deflection),
- pipe-by-pipe assembly is possible so space required is only small,
- the ZM-U coating is a guarantee of mechanical and chemical protection,
- extremely long technical operating life.



Fig. 10:
The Albert Canal near Geel in Belgium after a culvert pipeline of DN 500 ductile iron pipes was installed

The QR code shown below (**Fig. 11**) will take you to a video showing the DN 500 HDD operation on the Albert Canal near Geel in Belgium (**Fig. 10**).



Fig. 11:
QR code – DN 500 HDD
operation near Geel, Belgium

References

- [1] Nöh, H.:
Moseldüker Kinheim, grabenloser Einbau von Gussrohrleitungen mit der FlowTex-Großbohrtechnik
GUSSROHR-TECHNIK 30 (1995), p. 25
- [2] Hofmann, U. and Langner, T.:
Einziehen eines 432 m langen Rohrstranges DN 500 mit gesteuerter Horizontalbohrtechnik – ein wichtiger Beitrag zum Umweltschutz in Oranienburg an der Havel
GUSSROHR-TECHNIK 32 (1997), p. 5
- [3] Fitzthum, U., Jung, M. and Landrichter, W.:
Eine Baumaßnahme der besonderen Art: 1.100 m Leitungsbau mit duktilen Gussrohren DN 600 blieb von den Anliegern in Fürth unbemerkt
GUSSROHR-TECHNIK 35 (2000), p. 33
- [4] Renz, M.:
Rekordpremiere mit duktilen Gussrohren DN 700 im Spülbohrverfahren in den Niederlanden
GUSSROHR-TECHNIK 37 (2003), p. 36
- [5] Ertelt, S., Lübbers, H. and Ramón, P.:
Horizontal-Spülbohrung DN 900 – Einbau duktiler Gussrohre mit gesteuerter Horizontalbohrtechnik HDD
GUSSROHR-TECHNIK 42 (2008), p. 90
- [6] Rau, L.:
The horizontal direction drilling technique – DN 700 – Germany's biggest HDD project, using DN 700 ductile iron pipes
DUCTILE IRON PIPE SYSTEMS No. 47, p. 61

- [7] DVGW-Arbeitsblatt GW 321
Steuerbare horizontale Spülbohrverfahren für Gas- und Wasserrohrleitungen – Anforderungen, Gütesicherung und Prüfung
2003-10
- [8] ISO 13470
Trenchless applications of ductile iron pipes systems – Product design and installation
2012
- [9] EN 545
Ductile iron pipes, fittings, accessories and their joints for water pipelines – Requirements and test methods
2010
- [10] EN 598
Ductile iron pipes, fittings, accessories and their joints for sewerage applications – Requirements and test methods
2007 + A1:2009
- [11] EN 15542
Ductile iron pipes, fittings and accessories - External cement mortar coating for pipes - Requirements and test methods
2008
- [12] DIN 30675-2
External corrosion protection of buried pipes; corrosion protection systems for ductile iron pipes,
April 1993
- [13] EN 545
Ductile iron pipes, fittings, accessories and their joints for water pipelines – Requirements and test methods
2006
- [14] DIN 30672
Tape and shrinkable materials for the corrosion protection of buried or underwater pipelines without cathodic protection for use at operating temperatures up to 50°C
200 0-12
- [15] DVGW-Arbeitsblatt GW 301
Qualifikationskriterien für Rohrleitungs-
bauunternehmen
1999-07
- [16] DVGW-Arbeitsblatt GW 302
Qualifikationskriterien an Unternehmen für grabenlose Neulegung und Rehabilitation von nicht in Betrieb befindlichen Rohrleitungen
2001-09
- [17] DVGW-Arbeitsblatt GW 329
Fachaufsicht and Fachpersonal für steuerbare horizontale Spülbohrverfahren; Lehr- und Prüfplan
2003-5
- [18] DVGW Hinweis W 401
Entscheidungshilfen für die Rehabilitation von Wasserrohrnetzen
1997-09

Author

Dipl.-Ing. (FH) Stephan Hobohm
Duktus Rohrsysteme Wetzlar GmbH
Sophienstraße 52-54
35576 Wetzlar, Germany
Phone: +49 (0)64 41/49-12 48
E-mail: stephan.hobohm@duktus.com

Trenchless rehabilitation by pipe relining

Replacement of the HW 1.1 DN 700 water main between Hattersheim and the Sindlingen district of Frankfurt

by Alexander Scholz

1 Introduction

The planning, installation and operation of supply networks is the job of NRM Netzdienste Rhein-Main GmbH, a subsidiary of the supply companies Frankfurter Mainova AG and Stadtwerke Hana. As well as networks for electricity, natural gas and district heat, NRM also operates a 2,000 km long drinking water network in the region of the metropolitan area of Frankfurt am Main.

This drinking water network is subject to a constant ageing process and this is causing increased amounts of age-related damage, particularly to the very old pipelines, some of which were first put into operation 100 years ago.

This is the background against which NRM is currently rehabilitating an important water main between Hessenwasser's pumping station at Hattersheim and Frankfurt city centre (Fig. 1).

2 Background to the project

This section of the water main is some 17.4 km long and because of the increase in age-related damage to it, a start was made on rehabilitating it in 2008.

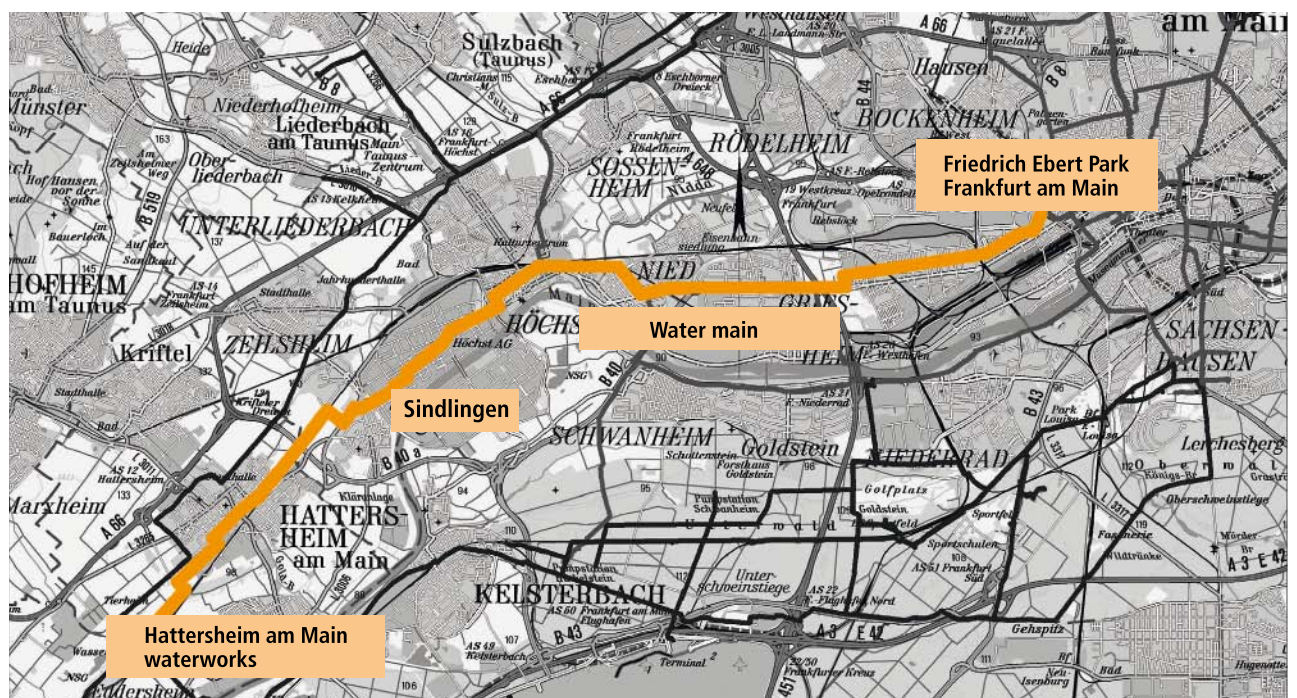

Fig. 1: Overview of the project – Rehabilitation of the HW 1.1 DN 700 water main [source: NRM]

The characteristics of the existing main to be rehabilitated were as follows:

- Total length to be rehabilitated: 17.4 km
- Years of installation: 1920-1940
- Nominal size: DN 700
- Pressure rating: PN 10
- Materials: 6.5 km of grey cast iron/
10.9 km of steel

At the moment the 6th section of the rehabilitation work has been done from Hattersheim to Frankfurt's Sindlingen district. This is 1,500 m long.

2 Installation technique and pipes selected

The first steps of planning got under way in 2008 with a basic check on the hydraulic cross-section which would be needed for the section of the main to be rehabilitated. Water consumption had dropped over the past few years and was now at a steady level and on this basis the cross-section of the main could be reduced from DN 700 to DN 400.

This reduction in cross-section was followed by a more extensive feasibility study including a consideration of the various options available. As part of this, the possible rehabilitation techniques and pipes were compared against the background of the constraints relevant to the project. Trenchless rehabilitation techniques were found to have convincing advantages from, above all, the technical and economic points of view.

The result was that pipe relining with DN 400 ductile iron pipes with a cement mortar lining and coating and BLS®/VRS®-T push-in joints (**Figs. 2 and 3**) was selected for the run to be rehabilitated. What decided the selection of this technique and these pipes was, above all, the short time required for assembling the pipe joints (required time for planning purposes: ~ 20 min) and the possible angular deflection of 3° in the region of the socket joints.

Table 1 shows the dimensions, operating pressures, allowable tractive forces, allowable angular deflections and number of locking segments for different nominal sizes.

3 Planning the 6th section of rehabilitation work

The 6th section ran from Hattersheim to Frankfurt-Sindlingen and the length to be rehabilitated was some 1,500 m. Following the basic

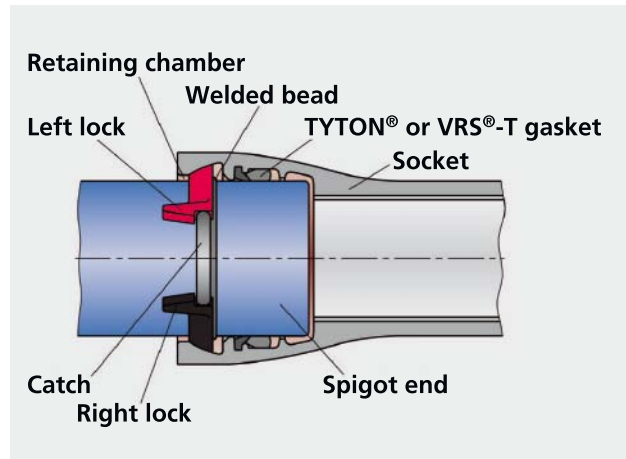

Fig. 2:
The BLS®/VRS®-T push-in joint
[Source: Duktus Rohrsysteme Wetzlar GmbH]

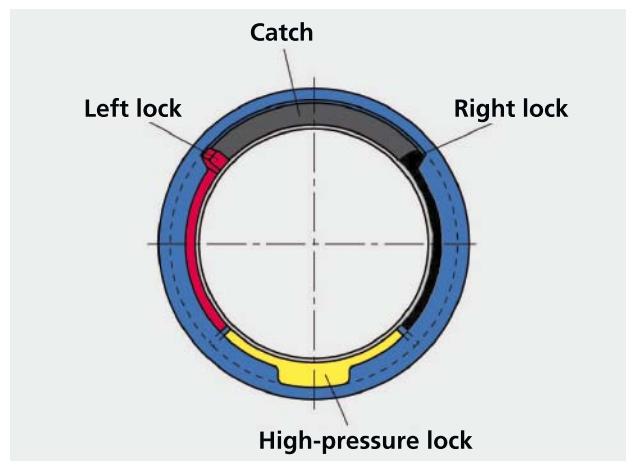

Fig. 3:
Positive locking parts of BLS®/VRS®-T push-in joint
[Source: Duktus Rohrsysteme Wetzlar GmbH]

decision about the rehabilitation technique and against the background of the constraints, a 1,314 m long relining section was planned. Because of horizontal and vertical changes in direction, provision was made for another 165 m to be rehabilitated in open trenches.

The main factor influencing the planning and execution of the work in the section intended for relining was the German Federal Railways railway track (the Frankfurt-Wiesbaden line) which follows a parallel route. This being the case, what mainly had to be taken into account in planning the installation pits and in the consents which had to be obtained was the Railway Crossing Guidelines of the German Federal Railways.

Table 1:

Properties of BLS®/VRS®-T push-in joints [Source: Duktus Rohrsysteme Wetzlar GmbH]

DN	d ₁ [mm]	D [mm] ¹	t [mm]	Operating pressure PFA [bar] ²	Allowable tractive force F _{zul.} [kN] ³	Allowable angular deflection [°]	Number of locking components
80 ⁵	98	156	127	100/110 ⁴	115	5	2/3 ⁴
100 ⁵	118	182	135	75/110 ⁴	150	5	2/3 ⁴
125 ⁵	144	206	143	63/110 ⁴	225	5	2/3 ⁴
150 ⁵	170	239	150	63/75 ⁴	200	5	2/3 ⁴
200	222	293	160	42/63 ⁴	350	4	2/3 ⁴
250	274	357	165	40/44 ⁴	375	4	2/3 ⁴
300	326	410	170	40	380	4	4
400	429	521	190	30	650	3	4
500	532	636	200	30	860	3	4
600	635	732	175	32	1.525	2	9
700	738	849	197	25	1.650	1,5	11
800	842	960	209	25	1.460	1,5	14
900	945	1.073	221	16/25 ⁵	1.845	1,5	13
1.000	1.048	1.188	233	10/25 ⁵	1.560	1,5	16

¹ Guideline value
² Operating pressure (PFA): allowable operating pressure in bars – basis for calculation was wall-thickness class K 9 includes use of high-pressure lock at up to and including DN 250
³ The tractive forces can be increased by 50 kN when the route followed is straight (max. of 0.5° angular deflection per joint). High-pressure lock required at DN 80–DN 250.
⁴ With high-pressure lock
⁵ Wall-thickness class K 10

Because of the land used for agricultural purposes adjacent to the existing route, the requirements of the farmers also had to be allowed for in the planning. This affected the planning of the facilities for access and storage in the region of the installation pits.

Because of the preset path followed vertically and horizontally by the existing main and because of the existing items installed along it, the section for relining had to be divided into five pulled-in runs. The resulting lengths of the runs were:

- 67 m,
- 255 m,
- 271 m,
- 315 m und
- 406 m.

A consequence of these sections selected for relining was that eight installation pits had to be planned. A distinction has to be made in this case, between insertion pits and pulling-in pits.

The insertion pits measured 8.5 m in length by 2.5 m in width. The pipes were lifted into the insertion pits by a hoist and were connected together as restrained pipes by means of their BLS®/VRS®-T push-in joints. The pulling-in pits were planned to measure 6.0 m in length by 2.5 m in width and were used to accommodate the hydraulic pulling-in rig.

Depending on the vertical position of the existing main, the depth of the installation pits varied between 2.5 m and 3.5 mm.

The five installation pits which had to be positioned in parallel with the trackbed of the railway were sized to suit increased loads. As a result, the shoring specified for these pits was of special components with additional stiffening at the bottom.

4 Doing the relining work

On completion of the planning and invitation to tender phase, the execution of the relining work was able to begin in July 2012.

After the 1,500 m long section of water main to be rehabilitated had been withdrawn from service, a start was made on mobilising the installation site and on setting up the temporary signs and barriers for traffic in the region of the relining pits. Following this, the activities below ground level began for the digging of the installation pits and the 165 m long pipeline trench for the laying of the open-trench section.

Once the installation pits had been completed, the existing main was cut and was cleaned mechanically.

The actual pulling-in of the pipes was done by a crew of five workers.

The 6 m long pipes to be pulled in were laid down in the pits on a trough-like auxiliary structure by an excavator. Once the pipe had been exactly lined up, the socket joint was assembled (**Fig. 4**), which included protecting it with a rubber sleeve and a sheet metal cone. The string of pipes was then pulled into the existing main for another 6 m by means of a hydraulic cable winch.

By this procedure, it was possible to install between 18 m and 24 m of pipeline in an hour.



Fig. 4:
Assembling a BLS®/VRS®-T push-in joint
[Source: NRM]

When preparations were being made for pulling in the DN 400 cement mortar lined and coated ductile iron pipes, the theoretical allowable tractive force found for the longest section to be pulled in, the 408 m one, was 45.69 t. This tractive force was found from the number of DN 400 ductile iron pipes (67) and their weight and allowed for the fact that restrained BLS®/VRS®-T push-in joints were being used.

On this basis and assuming that the tractive force would not need to be that high, the installing company which had been given the contract opted for a hydraulic winch (**Fig. 5**) with a maximum tractive force of 40 t and a maximum travel per stroke of 115 m.



Fig. 5:
The hydraulic traction rig [Source: NRM]

This traction rig was installed in the different pulling pits section by section of the work, and was supported against the shoring of the pits. The 500 m supply of cable was positioned on a crab winch outside the pit.

To ensure the tractive forces allowable under DVGW Arbeitsblatt GW 320-1 [1] were not exceeded, NRM attached particular importance to the measurement and documentation of the levels actually reached by the tractive forces.

The maximum tractive force finally documented for the 408 m long section of the relining work was one of 183 kN. Calculation then showed there to have been a coefficient of friction of about $\mu = 0.41$. This value is thus in line with previous experience [2, 3].

The tractive forces documented were also well below the 650 kN allowable for the push-in joint used (**Table 1**) and the 558 kN allowable under DVGW Arbeitsblatt GW 320-1 [1].

On completion of the pulling-in of the pipes, the complete new section was divided into two and pressure testing and disinfection was carried out on these two sub-sections.

The replaced sections of the main could thus be put back into operation after an installation period of four months. In the open-trench section of the main the work of restoring the surface continued until mid-November 2012.

5 To sum up

Recourse to information obtained from experience with a variety of trenchless rehabilitation techniques in the inner-city area of the city of Frankfurt and to careful planning and preparation for the project on this basis laid the foundations for the work to be done in an almost ideal way. The project thus achieved its aims in respect of quality, deadlines and cost.

One thing amongst others which should be stressed in this connection was the sensible combining of the pipe relining technique which was used with the restrained ductile iron pipe systems. The technical and economic advantages of the technique are particularly clear from the reduction in the cost of the work done below ground level. Compared with conventional installation in open pipeline trenches, around 80% of the cost of the work done below ground level could be saved.

The planning and execution of the 6th section of the rehabilitation work on the HW 1.1 water main can be chalked up as a complete success for NRM Netzdienste Rhein-Main GmbH.

References

- [1] DVGW-Arbeitsblatt GW 320-1
Erneuerung von Gas- und Wasserrohr-
leitungen durch Rohreinzug oder
Rohreinschub mit Ringraum
2009-02
- [2] Schnitzer, G., Simon, H., and Rink, W.
Langrohrrelining DN 900
in Leipzig Mockau
GUSSROHR-TECHNIK 39 (2005), p. 20
- [3] Rink, W.
Langrohrrelining mit duktilen
Gussrohren DN 800
GUSSROHR-TECHNIK 38 (2004), p. 17

Author

Dipl.-Ing. Alexander Scholz
NRM Netzdienste Rhein-Main GmbH
Solmsstraße 38
60486 Frankfurt am Main, Germany
Phone: +49 (0)69/2 13 8 18 58
E-mail: al.scholz@nrm-netzdienste.de

Client

NRM Netzdienste Rhein-Main GmbH
Dipl.-Ing. Alexander Scholz
Solmsstraße 38
60486 Frankfurt am Main, Germany
Phone: +49 (0)69/2 13 8 18 58
E-mail: al.scholz@nrm-netzdienste.de

A record for the burst lining technique in Austria

A DN 400 drinking water pipeline of ductile iron pipes pulled in trenchlessly in Linz

by Stefan Koncilia

1 Introduction

Now Austria has a “trenchless record” of its own! In April 2012, a drinking water pipeline of ductile iron pipes of DN 400 nominal size was pulled in by the burst lining technique in Linz, the capital of the state of Upper Austria. In terms of diameter this is the biggest operation to date by this technique in the Alpine republic. The project attracted considerable attention in professional circles and this was one of the reasons for the comprehensive press coverage of the installation site on the Landstraße in Linz. Ductile iron pipes are outstandingly well suited to trenchless laying techniques.

What made a crucial contribution to the shared success was the collaboration between the client, i.e. the Water Department of Linz AG of Linz, the installing company SWIETELSKY-Faber of Leonding, and the pipe supplier Duktus Tiroler Rohrsysteme GmbH of Hall in Tirol.

2 A renovation project posing many challenges

Linz is Austria’s third largest city and last year it embarked on an ambitious project in the field of townscape design – the redesign of the Landstraße, which is considered to be one of Austria’s most successful shopping streets. The aim is to make the 1.3 kilometre long street even more attractive and to entice visitors to stroll along it and enjoy a chat with one another.

It is easy to see why the first thing on the agenda was to get things in order “below ground”. This was why Linz AG, Linz’s municipal supply company, decided to replace a drinking water transporting pipeline of grey cast iron

which was already quite a few decades old and no longer safe, with a new pipeline of ductile iron pipes. Two sections totalling 200 metres in length were to be replaced. Trenchless replacement of the drinking water pipeline by the burst lining technique proved to be the most economical procedure, the one that was kindest to the environment and most sparing of resources and above all the one that was best for traffic [1]. This was because a basic requirement was for the underground work to be limited to only three days over a weekend in order not to cause any disruption to the many business premises on the street. The pipeline was at a depth of 1.4 metres so the alternative, open trench installation, as well as having its well known disadvantages would also have meant a considerably longer installation time and above all a suspension of the tram service which runs right next to the route of the pipeline (**Fig. 1**).



Fig. 1: Thanks to the space saved by the installation site, the tram service could be maintained on the Landstraße

The burst lining technique under GW 323

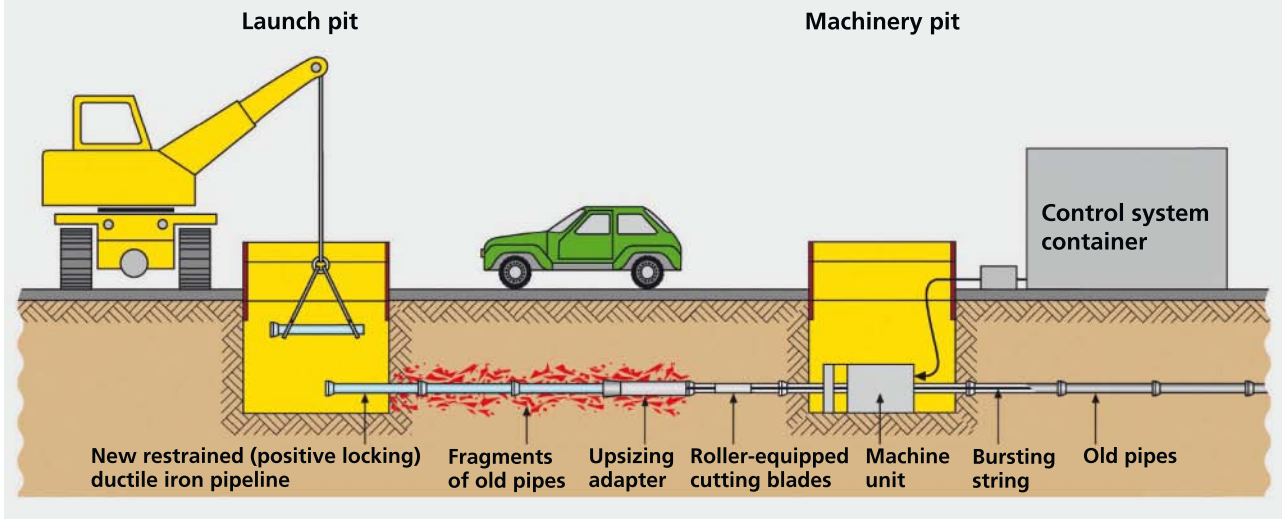

Fig. 2:
A diagram of the static burst lining technique under GW 323 [1]



Fig. 3:
A 1,900 kN tractive force traction rig made by the TRACTO-TECHNIK GmbH & Co. KG company being used for the first time in Austria.

3 Replacement by the static burst lining technique

Because no change was needed to the DN 400 cross-section of the pipes or to the hydraulic performance, the static burst lining technique was selected (**Fig. 2**). This allows pipes of the same or larger sizes to be pulled in along the same route. The Austrian burst lining specialists, the SWIETELSKY-Faber Kanalsanierung GmbH company, were given the job of doing the work. Machinery (a traction rig) generating sufficiently high tractive forces was required to

burst the old grey cast iron pipeline, to upsize the existing passage and at the same time to pull in the cement mortar coated ductile iron pipes. A further requirement was for the tractive forces to be measured and documented because the DN 400, K 9, ductile iron pipes could only be loaded to a maximum of 650 kN. A traction rig generating 1,900 kN of tractive force made by TRACTO-TECHNIK GmbH & Co. KG company was used for the first time in Austria for this work on Linz's Landstraße (**Fig. 3**).

The operation of actually carrying out the installation work was a major challenge. In surveying the third-party cables, pipelines, etc. it was found that as well as some electricity cables crossing the water pipeline there was also a gas pipeline running parallel to it at a distance of only 25 centimetres. The trial holes dug confirmed this. Jointly with the local gas supplier, it was decided that the bursting operation would be continuously monitored by gas detectors.

4 Doing the installation work

For the burst lining technique to be carried out, the traction rig was first installed in the machinery pit and connected to the hydraulic drive unit. The special bursting string was then pushed through the old pipeline by the rig. The bursting head and the 610 mm diameter up-sizing cone were fitted to the string in the pipe



Fig. 4:
A DN 400 cement mortar coated pipe with a BLS®/VRS®-T push-in joint in the installation pit



Fig. 6:
Unloading a new DN 400 ductile iron pipe and lowering it into the pipe insertion pit



Fig. 5:
The old grey cast iron pipeline having been burst, the passage was upsized to 610 mm at the same as the new DN 400 ductile iron pipes were pulled in



Fig. 7:
The new DN 400, K 9, ductile iron pipeline arriving in the machinery pit

insertion pit. By means of an electronic tractive-force logging unit (Groundolog), the first new pipe was then fastened straight to the upsizing cone. The Groundolog has an on-line measuring system which transmits the tractive forces measured while the pipes are being pulled in straight to a receiver on the surface. This ensured that the allowable tractive forces on the new DN 400 ductile iron pipes with BLS®/VRS®-T push-in joints (**Fig. 4**) were not exceeded.

As it was pulled back, the bursting head fitted with cutting blades burst the old grey cast iron pipeline and the upsizing cone which followed upsized the existing passage and pulled the new ductile iron pipes in at the same time (**Fig. 5**). Because of the sockets of the new DN 400 ductile iron pipes, the upsizing was to

610 mm. The new ductile iron pipes were each 6 m long and were lifted into the pipe inserting pit cycle by cycle (**Fig. 6**), and the restraint was applied by means of locks. To protect them against the fragments of old grey iron pipe left in the native soil, the new ductile iron pipes had a cement mortar coating (ZM-U).

Fig. 7 shows the new ductile iron pipeline arriving in the machinery pit.

5 ZM-U pipes show how rugged they are

At 500 kN, the pulling-in forces which were measured and documented were well below the limiting load of 650 kN allowable on the BLS®/VRS®-T push-in joints of the new DN 400 ductile iron pipes. The total force measured at the bursting rig varied between 1,200 kN and 1,600 kN.

The companies involved worked together well and this enabled the work on Austria's largest nominal size burst lining site to be completed on schedule in three days to everyone's complete satisfaction.

References

- [1] DVGW-Merkblatt GW 323
Grabenlose Erneuerung von Gas- und
Wasserversorgungsleitungen durch
Berstlining;
Anforderungen, Gütesicherung und
Prüfung,
July 2004

Author

Ing. Stefan Koncilia
SWIETELSKY-Faber Kanalsanierung GmbH
Haidfeldstraße 44
4060 Leonding, Austria
Phone: +43 (0)732/69 71-77 60
E-mail: s.koncilia@swietelsky-faber.at

A wide range of practical applications for pre-insulated ductile iron pipes

by Lutz Rau

1 Introduction

Cast iron is not only one of the oldest materials used for pipes but also one of the most innovative. Whereas in earlier times grey cast iron was used as a material, the material applied since the sixties has been ductile cast iron. As a material, ductile iron is not at risk of fracture even when there are wide differences in temperature. It will withstand high static and dynamic loads. There is a full range of pipes and fittings for gravity and pressure pipelines of nominal sizes from DN 80 to well over DN 1000 and the linings, coatings and restraint systems for these are the subject of constant ongoing development. The wide variety of production techniques available mean that complete solutions can be found for almost any application.

As the ductile iron pipe system has developed, so too have the demands made in practical modern-day installation. Entirely new fire-fighting systems in tunnels, trenchless installation techniques, snow-making systems in the mountains and even the use of natural resources to generate electricity by means of turbine pipelines are now far from being niche applications. Climate change too, with its extreme variations in temperature and bouts of heavy rain after quite long dry spells, is making new demands on the water industry and hence on the installing and supply industries too. Simple, safe and swift assembly of ready-made components is essential for economical installation work.

2 The need for pre-insulated ductile iron pipes

As well as providing mechanical protection for supply and disposal systems in geographical regions where there are wide annual variations in temperature, another function the ground performs is to stop the medium transported by the systems from freezing. Another point is that the consistently low temperature of the surrounding ground has a beneficial effect on drinking water. If, due to technical or structural constraints, there is no certainty that a pipeline will not freeze, then pre-insulated ductile iron pipes (WKG pipes) are an elegant and economical alternative. The high quality of the design details of the WKG pipe system is reflected in the decades of satisfactory experience there has been with it in practice.

3 Fields of use for WKG pipes

In principle, any ductile iron pipe system can be equipped with pre-insulation. This is true both of systems with restrained joints for sewage and of such systems for drinking and non-drinking water. However, it needs to be made clear that without trace heating thermal insulation alone cannot prevent freezing but only delay it. As well as the standard thermally insulated systems, what can therefore also be supplied if required for pipelines in which flow is not continuous are various types of heatable systems. The high thermal conductivity of ductile iron is an advantage in this case. Guideline values for planners relating to "Heat loss times for standing water in fully filled pipes" can be found in [1]. **Fig. 1** is a schematic overview of the possible uses of WKG pipes.

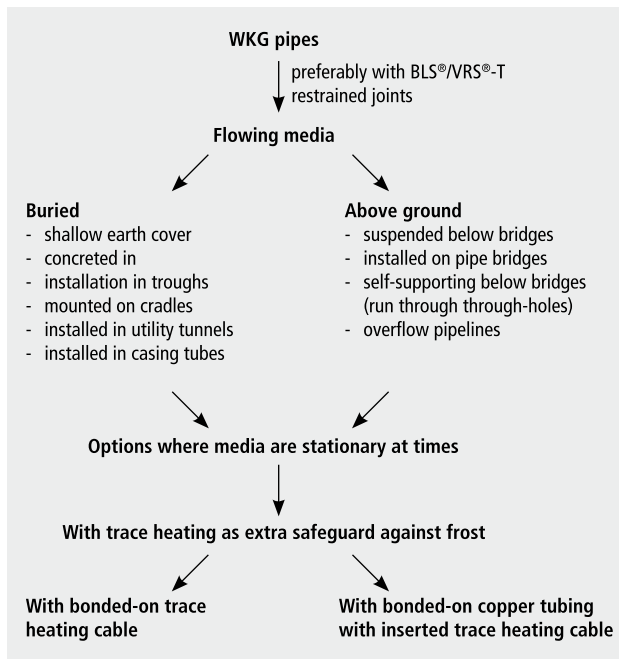

Fig. 1:
Schematic overview of possible uses of WKG pipes

4 Planning preparations

As well as the technical parameters of the particular project and the detailed agreements with the other companies, authorities, etc. involved, what is also important is selecting the right system.

It is advisable at the outset to get in touch with the applications engineering department of the pipe manufacturer or system supplier and to discuss the following points at a free consultative meeting:

- the accessories required (e.g. fasteners, clips, mountings, seals in pipe penetrations, electrical connectors for trace heating),
- the technical parameters (restraining system, outside diameter, thermal expansion, possible need for expansion joints, air-release valves, transitions to other pipe materials) and
- the installation technique (pushing in, lifting in, pulling in, laying in).

For a technically demanding operation, an early initial costing and constructional specifications for the other companies which will be doing work are essential if the costs are to remain reasonable.

Where construction is in concrete, provisions made at the design stage (recesses, use of the angular deflection at sockets on arched bridges, preparations for mountings) will mean only a small amount of expensive later adapting work. The joints envisaged should preferably

be positive locking restrained ones such as the BLS®/VRS®-T push-in joint. Depending on its contents, the viscosity and consistency of the medium flowing (e.g. drinking water or sewage) will change as a function of the outside temperature, the speed of flow and the nominal size of the pipes. The planner should plan on a worst-case basis, e.g. a breakdown during quite a long severe frost (over a weekend or a holiday), resulting in the medium remaining stationary in the pipeline for several days.

In road tunnels, the lorries entering draw ice-cold freezing air in with them, as a result of which temperatures appreciably below zero come into being in the entrance regions of tunnels. Because of the constant slight wind below bridges, pipelines suspended below them are also at risk of freezing.

As well the serviceability of the network becoming restricted, damage may later be caused to pipelines and valves, involving costly unplanned work. The possibility of further trouble cannot be ruled out even when the original breakdown on the network has been remedied.

On the one hand the increase in the volume of water as it freezes increases the pressure in the network and on the other hand other parts of the network freeze more quickly and components in the network may be damaged due to the expansion of the frozen water in the pipes.

Examples of frozen components and pipes are shown in **Figs. 2 and 3**.



Fig. 2:
Ice in a frozen hydrant

5 Principles of construction of a WKG pipe

To produce WKG pipes and fittings, standard ductile iron pipes to EN 545 [2] or EN 598 [3] and socketed fittings, with TYTON® push-in joints with the appropriate restraint systems, are enclosed in a layer of defined thickness of CFC-free rigid polyurethane (PUR) foam with a bulk density of 80 kg/m³.

For buried pipelines, the protective outer casing consists of HDPE tubes to EN 253 [4]. Pipelines below bridges have casings either of galvanized sheet steel to EN 1506 [5] or of sheet stainless steel. Plastic spacers ensure that the layer of thermal insulation is of uniform thickness. At the socketed end, the outer enclosing layers come to an end at the end-face of the socket, whereas the spigot end is left free for the connecting joint to be made. The gap that is left at the joint is later filled with slit rings of foam material and is then closed off with a sheet metal sleeve or, on buried pipelines, with shrinkable material. On socketed fittings, the materials terminate flush at the end (Fig. 4). To allow the bolts to be fitted, flanged fittings generally have to be re-insulated manually. Depending on the structural requirements, the air-release points needed may be provided in the form of thermally insulated Hawlinger valves (manual air release valves) (Fig. 5). Transitions to conventional cast iron pipes are made by means of end-caps of shrinking material which also protect the thermal insulation from moisture [1].

6 Assembling a WKG joint

The assembly of these joints is fundamentally different from that of standard commercial joints; the pipe manufacturers are able to supply special laying tools which fit the cylindrical external contour of the pipes. Pipes can be cut to length on site with the usual tools (Figs. 6, 7, 8 and 9).

7 Examples of installations

7.1 Burying – Re-laying of a drinking water pipeline across the Ilse canal

In the region of the Lusatia lakeland in Germany, lake Großräschen is connected to lake Sedlitz by the 1,197m long navigable Ilse canal. For a length of 226 m, the Ilse canal runs through a navigable tunnel below the railway line between Cottbus and Senftenberg and below the B 189 road. A water main needed



Fig. 3:
A SIT® push-in joint in a section of pipe insulated by hand after being forced apart by exposure to frost



Fig. 4:
DN 500 WKG bends for burying



Fig. 5:
A thermally insulated Hawlinger valve for air release on a WKG pipe



Fig. 6:
Preparing to assemble WKG pipes with BLS® push-in joints



Fig. 7:
Pulling the BLS® push-in joint together with an assembly tool



Fig. 8:
Inserting the slit rings of foam material in the region of the socket joint



Fig. 9:
Fully assembled sheet metal sleeve in the region of the socket joint

to be re-laid in the ceiling of the tunnel for a length of 246 m. What were selected to ensure freedom from freezing when installed in the tunnel ceiling were 183 m of DN 500 WKG pipes and two DN 500 bends, all with BRS® push-in joints (**Figs. 11 and 12**).

7.2 Berlin's Tiergarten tunnel

In this case, the tunnel segments were cast in in-situ concrete and the fire-fighting pipelines were installed in the ceiling of the tunnel within the reinforcement. Every 10 m, the joint to the next tunnel segment needed to be flexible (**Fig. 12**).

7.3 Installation with trace heating in a trough in a tunnel – autobahn tunnel under Tegel Airport

A DN 125 drinking water pipeline was installed in an already completed trough in the region of the edge of the footway and was covered with metal plates. To ensure that fire-fighting requirements could be met even though it was possible that the water in the fully filled pipeline might remain stationary at times, a trace heating system was installed in copper tubing mounted on the pipeline. The insulation at the sockets and spigot ends was therefore shorter to allow the heating cables to be connected (**Figs. 13 and 14**).

7.4 Self-supporting pipelines at short bridges and through-holes in trenches

Neuzelle

Before the concreting work was done on the carriageway over the bridge, a DN 200 WKG drinking water pipeline was slid from outside through the pre-made lateral penetrations in the side-walls of the bridge. The gap between the WKG pipes and the penetrations through the concrete was filled with flexible foam and the transitions to the existing pipeline shortly after the side-walls of the bridge were of a flexible type (**Fig. 15**).

Beeskow, Bahnhofstraße

Following the demolition of the old arched drainage sewer, the steel pipeline crossing it was replaced by a new DN 200 WKG pipeline between the concrete side-walls of the bridge. In this case too the replacement took place before the bridge was finally built. The pipe seals in the penetrations are elastic; given the concrete side-walls, the flexible joint is arranged to be sealed on the outside (**Fig. 16**).



Fig. 10:
The Sedlitz project – unloading the DN 500 WKG pipes on site



Fig. 11:
The Sedlitz project – Installing the DN 500 WKG pipes in the open pipeline trench



Fig. 12:
Berlin's Tiergarten tunnel – Assembling WKG pipes within the reinforcement in the ceiling of the tunnel



Fig. 13:
Berlin Tegel airport – a branch pipe off the DN 125 WKG pipeline; installation in a trough in the tunnel



Fig. 16:
Crossing over a receiving water on the Bahnhofstraße in Beeskow – WKG pipes with polyethylene outer tubing



Fig. 14:
Berlin Tegel airport – DN 125 WKG pipes installed in the tunnel with trace heating

7.5 DN 250 pipeline on a bridge

Potsdam, Glienicke

This bridge is a relic of divided Germany but is still being used as a bridge for services; the old steel drinking water pipeline has been replaced by DN 200 WKG pipes with folded spiral-seam outer tubing, the pipes having BLS® type restrained joints. The pipes are held in cradles by double clips (**Fig. 17**).



Fig. 15:
Crossing over a receiving water in Neuzelle – DN 200 WKG pipes with folded spiral-seam outer tubing



Fig. 17:
A pipeline bridge for services in Potsdam – DN 200 WKG drinking water pipes with folded spiral-seam outer tubing

7.6 WKG pipes in casing tubes

Potsdam, Nesselgrundbrücke

When the new Nesselgrund bridge between Potsdam and Michendorf was built over the railway tracks it was necessary for a new DN 300 drinking water main some 80 m long to be laid as well. German Federal Railways have special requirements relating to water pipelines crossing above electrified railway tracks and because of this the pipeline had to be installed to be restrained and safe from frost in the protective casing tubes. The company doing the installation work benefited from the fast and safe assembly of the pipes and from the supply by the pipe manufacturer of the traction head and installing tools. The pipes were pulled in on pre-fitted skids for sliding (**Fig. 18**).

Suspended pipelines

Figs. 19, 20, 21 and 22 show some examples of pre-insulated ductile iron pipes used on bridge and lock structures.

8 Concluding remarks

There have been a number of reports on various WKG installations in previous EADIPS®/FGR® Journals and the reader can thus find information on far more reference installations and variant techniques than could be outlined in the present article.

If careful preparations are made and the manufacturer is consulted, WKG pipe systems are able to provide an optimal and economical solution to meet special requirements. They are safe, long-lived, backed by large numbers of reference installations, easy and quick to assemble and have high safety margins even under extreme loads. **Figs. 19 and 22** show pipelines which have been in operation for years without giving trouble and without needing to be maintained; this is another plus point in favour of rugged WKG pipes.



Fig. 18:
DN 300 WKG pipes being pulled in on the Nesselgrund bridge

References

- [1] Duktus Manual
Ductile iron pipe system for drinking water
2012-07
- [2] EN 545
Ductile iron pipes, fittings, accessories
and their joints for water pipelines –
Requirements and test methods
2010
- [3] EN 598
Ductile iron pipes, fittings, accessories
and their joints for sewerage applications –
Requirements and test methods
2007 + A1:2009
- [4] EN 253
District heating pipes. Preinsulated
bonded pipe systems for directly buried
hot water networks. Pipe assembly of
steel service pipe, polyurethane insulation
and outer casing of polyethylene
2009 + prA1: 2011
- [5] EN 1506
Ventilation of buildings. Sheet metal
air ducts and fittings with circular
cross-section.
Dimensions
2007



Fig. 19:
The Wernsdorf lock: twin WKG pipelines suspended below the road bridge



Fig. 21:
The Rathenow lock: a WKG pipeline suspended below the road bridge behind a concrete skirt



Fig. 20:
The Brandenburg lock: a WKG drinking water pipeline suspended behind an outer skirt of trapezoidal profile metal panels



Fig. 22:
The Hohenauen bridge: a suspended WKG pipeline with no bridge skirt

Author

Dipl.-Ing. Lutz Rau
 Duktus Rohrsysteme Wetzlar GmbH
 Verkaufsbüro Berlin
 Am Schonungsberg 45
 12589 Berlin, Germany
 Phone: +49 (0)30/64 84 90 70
 E-mail: lutz.rau@duktus.com

Applications of ductile iron pipe systems in the energy and water industries

by Jürgen Rammelsberg

1 Introduction

On the 23rd and 24th of April 2012, the FIHB (Fördergemeinschaft zur Information der Hochschullehrer für das Bauwesen - this association promotes the dissemination of information to college and university teachers teaching civil engineering and construction) was once again the guest of the EADIPS®/FGR® to learn about the latest developments in the European ductile iron pipe industry. This long-standing conference was devoted to the following main topics

- new installation techniques,
- new fields of application,
- properties of the material of ductile iron pipe systems.

The European Association for Ductile Iron Pipe Systems · EADIPS®/Fachgemeinschaft Gussrohrsysteme (FGR®) e. V. had been faithful to its international nature in organising the conference on the territory of its Swiss member vonRoll hydro (suisse) ag of Zurich and Emmenbrücke. These are very attractive places and 28 college and university teachers from the German-speaking part of the world had accepted the invitation to attend. A particularly important role was played by Wasserversorgung Zürich, the city of Zurich's water supply company, which had made the lecture room available in which the papers were given (**Fig. 1**). The company also provided an expert guide to give the interested guests a tour round its treatment plants and laboratories. May we once again express our grateful thanks to Wasserversorgung Zürich for its hospitality!

Wasserversorgung Zürich supplies a total of 891,000 inhabitants in the city and 67 municipalities in the surrounding area with

55 million m³ biological indicators which are used, round the clock, to check the purity of the water after treatment.

As a prelude to the series of papers, **Ulrich Päßler**, chairman of the board of the EADIPS®/FGR®, first introduced the programme of seminars which he had been giving under the motto of the superior sustainability of ductile iron pipe systems.

On behalf of the college and university teachers attending, **Prof. Dr.-Ing. Prof. h. c. Wolfgang Krings**, chairman of the board of the FIHB, then expressed his thanks for the invitation and stressed the importance of these conferences for teachers, at which the close relationship between theory and practice in the training of young engineers was being fostered and made even closer.



Fig. 1: Attentive listeners to the papers in Wasserversorgung Zürich's big lecture room

2 Review of the papers

2.1 DN 500 water mains in the Sonnenberg tunnel in Lucerne

Roger Saner of vonRoll hydro (suisse) ag opened the series of papers with a description of the planning and installation of a DN 500 drinking water main of ductile iron pipes for the city of Lucerne. It became necessary for the main to be installed when the Sonnenberg tunnel on the A2 autobahn had to be brought up to present-day requirements in respect of safety, capacity and maintenance. A completely new idea is being used to divorce the tunnel's function in carrying utility pipelines from its function in carrying motor traffic by positioning a dedicated utility gallery between the two traffic tubes of the tunnel (**Fig. 2**). All the pipelines and cables for drinking water, fire-fighting water, surface water, gas, electricity, communications, etc. are being housed in this utility gallery and will thus be accessible at all times for maintenance without the need to interfere with traffic. The installation of ductile iron pipes for fire-fighting and drinking water called for wide-ranging planning and design skills and the applications engineers at vonRoll hydro (suisse) ag were able to contribute to the success of the project by showing a due measure of these.

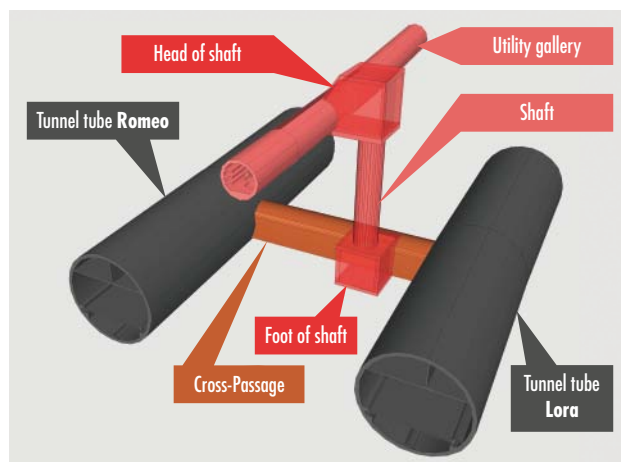

Fig. 2:
A schematic representation of the utility gallery between the two traffic-carrying tunnel tubes

A detailed description of the project giving background information, technical details and aims can be found from page 22 on in the present Journal.

2.2 The effect of electric currents on cast iron pipelines, and protective measures

The second paper was given by **Dr. Markus Büchler** of the Swiss Society for Corrosion Protection. He provided an informative overview of the fundamental electrochemistry involved in the processes by which metals corrode and went on from this to the measures needed for the sustainable reliability of buried pipelines. At the same time, he put the spotlight on the coatings which can be used to counter the attacks from different soils and ambient conditions. These coatings were introduced for ductile iron pipes decades ago and have been a proven success ever since. It was his lucid description of the fundamental electrochemistry which the college and university teachers found particularly interesting.

2.3 A pipeline of DN 700 ductile iron pipes for meteoric water, below the water table and on pile foundations

Simon Friedli of BSB + Partner, Ingenieure + Planer read a paper on an important project in the region of the Swiss Seeland. The project related to the installation of a pipeline for meteoric water where the soil conditions were highly unfavourable. The pipeline of DN 700 ductile iron pipes is at a gradient of only 0.3% and most of it is below the water table. The soil, of peat, sediment deposits and lake marl, is very prone to settlement and has only limited bearing capacity and the pipeline had to be installed in it on foundation piles. The pile foundation reaches down to the stratum of gravel able to bear loads at a depth of 12 m to 15 m. At the laying length of 6 m, only one pile was needed per pipe, because the longitudinal bending resistance of ductile iron pipes permits spans this long without any problems. Given the position below the water table, another advantage was the socket joint, which remains watertight even if there is an external over-pressure. **Fig. 3** shows pipes being assembled on the heads of the piles.

2.4 Penstock pipelines

Since governments have started subsidising renewable energies, there has been a dramatic rise in the installation of penstock pipelines for small hydroelectric power stations. The output of a hydroelectric power station increases with the supply of water at the head, which means that high operating pressures at the foot of the penstock pipeline have to be safely kept under control by its pipes. An important aspect of



Fig. 3:
Pipes being assembled on the heads of piles

metal pipes of steel or ductile iron is their fracture mechanics behaviour. This has to be such that, if there is a dynamically stressed flaw, the spontaneous growth of cracks can be reliably prevented.

Fracture mechanics characteristics of ductile iron pipes when used for installing penstock pipelines, based on sets of tests carried out on ductile iron pipes

By reference to studies made of the fracture mechanics of ductile cast iron, **DI Dr. techn. Richard Huber** of the Institute for Technical Experimentation and Research (TVFA) of Vienna showed how particularly well suited this material is to use for the installation of penstock pipelines. It is mainly the spheroids of graphite which enable cracks to grow stably before the component fails, which they do by acting as “crack brakes”. With its purely ferritic microstructure, the material gives high levels of toughness, which allows the safety criterion of “leak before break” to be met. The results are now forming the basis for an exemplary growth in the application of ductile iron pipes to the installation of penstock pipelines for hydroelectric power stations, as is again demonstrated on pages 30, 34 and 39 of the present Annual Journal.

Use of ductile iron pipes in the high pressure range, taking a DN 400 penstock pipeline as an example

On a similar subject, **Stephan Hobohm** of Duktus Rohrsysteme Wetzlar GmbH gave a paper on the planning and installation of a penstock pipeline of DN 400 ductile iron pipes in Garmisch-Partenkirchen. He stressed the rugged



Fig. 4:
Installation of ductile iron penstock pipes in rocky terrain

external protection of fibre-reinforced cement mortar, which allows pipes to be installed in rocky ground without a sand bedding (**Fig. 4**).

2.5 The press-pull technique with soil removal – a report from the field

How innovative clients and installing companies find new solutions in the field of installation techniques was shown by the paper given by **Franz Schaffarczyk**, head of the Berlin branch of Josef Pfaffinger Bauunternehmung GmbH. The press-pull technique for pipeline replacement is well established in Berlin and from his report from the field on a development of this technique it was clear that with additional soil removal a considerable increase is possible in the nominal size of the new pipeline. For this development, Berlin’s water supply company Berliner Wasserbetriebe AöR, the Berlin branch of the Josef Pfaffinger Bauunternehmung GmbH company, and the Duktus Rohrsysteme



Fig. 5:
Winners of the 2nd prize in the GSTT Award 2011



Fig. 6:
Hosts and guests visiting vonRoll casting (emmenbrücke) ag

Wetzlar GmbH company were awarded 2nd prize in the 2011 Competition for Innovation organised by the German Society for Trenchless Technology E.V. (GSTT) (**Fig. 5**).

3 Other events during the conference

The programme for the 2012 Conference for College and University Teachers was rounded off by two excursions. These took the hosts and guests to Emmenbrücke to visit the foundry of vonRoll casting (emmenbrücke) ag (**Fig. 6**) and to inspect some of the plants operated by Wasserversorgung Zürich. In the evening the former cathedral cloister in Zurich's old-town and the "ZunftHaus zur Waag" restaurant were an ideal venue for the teachers and the experts from the EADIPS®/FGR® to meet and exchange views and experiences.

Author

Dr.-Ing. Jürgen Rammelsberg
European Association for Ductile
Iron Pipe Systems · EADIPS® /
Fachgemeinschaft Guss-Rohrsysteme
(FGR®) e. V.
Im Leuschnerpark 4
64347 Griesheim, Germany
Phone: +49 (0)61 55/6 05-2 25
E-mail: rammelsberg@arcor.de

Picture credits

Except where otherwise stated, the pictures appearing in the text were supplied by the authors.

Layout and production

Schneider Media GmbH, Erfurt

Published by and copyright

European Association for Ductile Iron
Pipe Systems · EADIPS® /
Fachgemeinschaft Guss-Rohrsysteme
(FGR®) e.V.
Im Leuschnerpark 4
64347 Griesheim, Germany

Phone: +49 (0)61 55 / 6 05-2 25
Telefax : +49 (0)61 55 / 6 05-2 26
E-mail: r.moisa@eadips.org

Editor

Dipl.-Ing. Raimund Moisa

Press date

05 April 2013

Text may be reprinted provided the source is acknowledged. Please supply a specimen copy.

www.eadips.org



Fig. 1:
QR code for EADIPS®/FGR® - website

Disclaimer

Whilst every care has been taken in the compilation of the material, information and content contained in this Annual Journal, and every effort is made to ensure that it is both accurate and up-to-date, the EADIPS®/FGR® makes no representations or warranties of any kind, express or implied, about the completeness, correctness, up-to-dateness or technical accuracy of such material, information and content. Whilst all reasonable steps have been taken to ensure that this Annual Journal is free from computer viruses, we accept no liability in respect of any loss, cost, damage, inconvenience or expense suffered as a result of accessing this Annual Journal. We also reserve the right to make, at any time and without prior notice, amendments or additions to or deletions from the material, information and content contained in this Annual Journal.

Through this Annual Journal you are able to access links to third-party websites which are not under the control of the EADIPS®/FGR®. We have no control over the nature and content of these third-party websites or over any changes made to them. We therefore accept no liability for the content of such third-party websites to which links are provided in our Annual Journal, or for links to further websites which are provided on such third-party websites.

Reproduction

Text, data, software and graphics appearing in this Annual Journal may be reprinted, reproduced, copied or used in other ways for non-commercial, private, education or training-related purposes provided always that the text, data, software and graphics are not modified and that an indication that the EADIPS®/FGR® is the copyright owner appears on every copy. Prior written consent must be obtained from us for any other use.

Logos of full members of the EADIPS®/FGR®

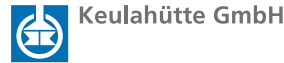

Logos of sponsoring members of the EADIPS®/FGR®



The EADIPS®/FGR® Standards Database



**European Association for
Ductile Iron Pipe Systems**
Fachgemeinschaft Guss-Rohrsysteme

**Standards and technical rules
connected with ductile iron pipe systems**

[Last search result](#) | [Search standards](#) | [Show all standards](#)

Search for standards and technical rules

Standard

Title

Edition

Country

Language

Keywords

Only the terms shown in the table below are stored as keywords. If you want to search for more than one of these terms at the same time, please enter them separated by a space and not by commas.

Deutsch/ german	Englisch/ english	Französisch/ french	Italienisch/ italien
Produktnorm	Product standard	Norme de produit	Norma del prodotto
Wasser	Water	Eau	Acqua
Rohre	Pipes	Tuyaux	Tubi
Formstücke	Fittings	Raccords	Raccordi
Armaturen	Valves		
Abwasser	Wastewater Sewage	Eaux usées	Fogna
Rohre	Pipes	Tuyaux	Tubi
Formstücke	Fittings	Raccords	Raccordi
Armaturen	Valves	Robinetterie	Rubinetteria
Anwendungsnorm	Application standard	Norme d' application	Norma d' applicazione
Wasser	Water	Eau	Acqua
Planung	Planning	Planification	Pianificazione
Bau	Construction Installation	Construction	Costruzione
Prüfung	Testing	Essai	Verifica
Betrieb	Operation	Exploitation	Esercizio
Abwasser	Wastewater Sewage	Eaux usées	Fogna
Planung	Planning	Planification	Pianificazione
Bau	Construction Installation	Construction	Costruzione
Prüfung	Testing	Essai	Verifica
Betrieb	Operation	Exploitation	Esercizio



Fig. 1:
QR code for the
EADIPS®/FGR®
Standards Database

On our German and English language website www.eadips.org, the EADIPS®/FGR® Standards Database is available to anyone who is looking for standards, directives or rules which need to be observed in connection with ductile iron pipe systems. Just click on the “Standards” button.

Further entries will continue to be added to the Standards Database.

When you open the Standards Database and click on “Search standards” you will see the entry template shown on the left. To make your search for a standard as quick and easy as possible, you can for example expedite it by entering preset Keywords in four languages. The entries you make do not need to be complete or exact. Search by the terms that are familiar to you.

We hope that the EADIPS®/FGR® Standards Database will be of practical assistance to you in performing whatever tasks you need it for.



EADIPS®

FGR®

**European Association for
Ductile Iron Pipe Systems**

Fachgemeinschaft Guss-Rohrsysteme

